

Nordiq Canada Competition Officials Manual

A Technical Manual for the Organization
of Cross Country Ski Events

Version 4.016, August 2020

Alan White, Editor



Preface

This publication has been prepared for the Events Committee of Nordiq Canada. It is designed to facilitate the development of a “Canadian Standard” for the officiating of Cross Country Ski competitions.

Preparation of this material has involved officials from across the country - people who have a great deal of experience in race and event organization, from club to international events. This version of the Manual tries to reflect the changes that have occurred over the past decade since the last edition. These changes include the use of sophisticated equipment and technology for highly-precise timing and very fast results production, as well as new formats of races. As a result, officials in this sport must also be kept up to date in order to be able to officiate in all levels of events. The Manual has been kept as ‘technology neutral’ as possible because we never know what advances in technology may bring before the Manual is updated. It is assumed that officials will develop expertise outside the contents of this Manual when it comes to handling technology.

This Manual has evolved with the premise that the way to run and officiate a cross country ski race at any level is best reflected in the way to run a national championship. World Cups, World Championships and Olympics involve processes and resources of the Fédération Internationale de Ski (FIS) which do not apply to domestic events. Treating domestic FIS races similarly to Nationals gives consistency of event delivery. Division Cups should present a sub-set of that level of organization with local events reflecting a further sub-set. By training all officials to the same high standard, the processes and equipment will be very familiar to everyone, so hosting such an event should be quite routine. It may not be necessary for a local one-day event to use all the processes and resources described here, but intelligent study of this Manual should provide you with the appropriate resource knowledge to be able to determine what to omit.

Competitions in Canada are governed by the Canadian Competition Rules which incorporate the FIS International Competition Rules (ICR). While reference is made in the Manual to certain rules by number it is important to be guided by a check on the latest version of the Rules before making decisions.

I would like to acknowledge the contributions of those who so kindly gave of their time and extensive knowledge:

Valuable contributions were made in their respective areas of expertise by Al Maddox, Len Apedaile, Ken Hewitt, Mike Norton, Debra Friendly, Stephanie Marler, Dirk Van Wijk and Frances Norlen. Finally Lisa Marr-Laing has been tireless in proofing to make sure terminology and grammar is consistent throughout the document.

The result of these efforts is this up-to-date Manual. I thank everyone for their very diligent, timely, and graciously-given expertise, experience and time. It has been a great deal of work for everyone.

It is expected that this Manual will be kept up to date. New versions with the updated sections will be made available to all through the Nordiq Canada web site. A list of changes will also be provided so that you will need to save only those pages that have changed to maintain a current manual.

I trust that this Manual will help all officials in Canada upgrade their skills in order that all competitors can enjoy the pleasure of well-run and fairly-officiated events.

Alan White

May 2020

Table of Contents

.....	i
Preface	ii
SECTION 1: EVENT ORGANIZATION	1
The Event Organizing Committee (EOC)	1
Chairperson/Manager	1
Chairperson, Venue Planning and Services	2
Chairperson, Athlete Services	2
Chairperson, Protocol and Hospitality	3
Chairperson, Finance	3
Chairperson, Marketing and Communications	3
Volunteer Co-ordinator	4
Event Organization Chart	6
SECTION 2: THE COMPETITION COMMITTEE	7
Responsibilities of the Competition Committee	7
Competition Committee Organizational Chart	8
Chief of Competition.....	8
Technical Delegate.....	12
The Jury.....	15
Protests	16
Protests during Sprint Competitions	16
SECTION 3: COMPETITION OFFICIALS PROGRAM	18
Officials Development	18
Classification of Officiating Roles	18
Major Role.....	19
Secondary Role	19
Officials Certification	20
Level 1 Official	20
Level 2 Official	22

Level 3 Official - Event Organizer	22
Level 3 Official - Technical Delegate – Nordiq Canada Divisional TD	23
Level 4 Technical Delegate - National TD	24
Level 5 Technical Delegate - FIS TD	25
FIS Popular or Roller-Ski Qualification	26
FIS World Cup TDs	26
WPNS Technical Delegate	27
Role of the Official	27
Sport Governing Bodies	28
SECTION 4: SKI TECHNIQUES AND RACE FORMATS	30
Ski Techniques	30
Classical Technique	30
Free Technique	30
Individual Competitions	30
Interval-Start Competitions	30
Mass-Start Competitions	31
Pursuit Competitions	31
Skiathlon Competitions	32
Individual Sprint Competitions	32
Qualification Round	33
Sprint Elimination Heats	33
Role of the Jury in Individual Sprints	34
Kings Court Sprint Heats	35
Team Competitions	35
Distance Relays	35
Team Sprint Competitions	35
Popular Cross Country Competitions (Loppets)	36
SECTION 5: Course Design and Homologation	37
Course Design	37
Back-Country Touring	37

Recreational Track Skiing	37
Competition Skiing.....	37
Homologation.....	39
Historical Perspective	39
Philosophy of Homologation.....	39
Homologation Policy for Nordiq Canada	40
Para Nordic Considerations.....	40
SECTION 6: COURSE PREPARATION & TRACK SETTING	42
Why Groom	42
Early Stages of Course Preparation	42
First Snow.....	42
Snow Making.....	42
Snow Farming.....	43
Early- to Mid-Winter (Pre-event)	43
Courses.....	43
Stadium	43
Equipment.....	43
The Event	44
Event schedule	44
Length of Time Required	44
Weather	44
Type of event.....	45
Free Technique Events	45
Classical Technique Events.....	46
Warm-Up Courses.....	46
Wax-Test Areas.....	47
Salting or Fertilizing Snow.....	47
Manual or “Touch-Up” Grooming During the Event	50
Para Nordic Considerations.....	51
Salt Testing Data.....	51
SECTION 7: COMPETITION CONTROL	52

The Requirement for Control	52
Chief of Competition Control	52
SECTION 8: COURSE OFFICIALS	56
Chief of Course	56
Chief of Mechanical Grooming	58
Machine Operators	58
Chief of Manual Grooming	59
Manual Groomers	59
Course Markers and Fencers	60
Chief of Forerunners	62
Forerunners	62
Course Closers	63
Chief of Course Marshals	63
Chief of Temperature Stations	64
Temperature Recorders	65
Temperature/Weather-Board Recorder	65
SECTION 9: STADIUM DESIGN AND PREPARATION.....	66
General Layout	66
Stadium Layout Designs.....	66
Through-Stadium Design.....	67
Horseshoe Stadium Design	68
Stadium Layouts - Starts	69
Interval Starts	70
Mass Starts	71
Individual Sprint Starts.....	74
Team Sprint Starts	74
Pursuit Competition.....	74
Stadium Layout – Exchange Zones	76
Exchange Zone – Skiathlon.....	76
Exchange Zone – Relays	77
Exchange Zone – Team Sprints	77

Exchange Zone – Para Nordic and Roller Skiing	78
Stadium Area – Finish Areas	78
Stadium Layouts – Lap/Through Area	79
Stadium Layouts – Other Areas.....	79
Feed Stations.....	79
Clothing Pickup Area.....	80
Ski Preparation, Testing and Warmup Areas	80
Stadium Equipment Details.....	81
Weather Board	81
Official Notice Board	81
Fencing and Dividers	82
Start / Finish Posts and Banners.....	82
Transponder Racks	85
Sponsor Banners and Signage	85
Timing Buildings and Placement	86
Announcer Area.....	87
SECTION 10: STADIUM OFFICIALS	88
The Requirement.....	88
Chief of Stadium	88
Chief of Stadium Preparation	90
Chief of Competition Equipment.....	91
Stadium Set Up Crew.....	92
Chief of Equipment Checking	93
Clothing and Equipment Checkers	94
Clothing Stewards	94
Transponder Distributors	94
Chief of Finish Line.....	95
Finish Line Stewards	95
Transponder Collectors	96
Chief of Feed Stations	96

Drink Pourers.....	98
Servers – On Course	98
Servers – Finish Area	98
Chief of Relay Exchange Zone.....	99
Exchange Zone Pre-Caller	99
Exchange Zone Controller	99
Exchange Zone Judge	100
SECTION 11: COMPETITION SECRETARIAT.....	101
Introduction	101
General Description of Responsibilities.....	102
Pre-event Planning and Communication	102
Accepting and Checking Entries	103
Late Entries.....	103
Pre-event On-site Activities	104
Team Captains’ Meeting	104
Preparation of Start Lists - The Draw and Seeding Process	106
Establishing the order of start within a category	106
Interval-Start Races	106
Mass-Start Races	106
Sprint Qualifying.....	107
Verification of Entries.....	107
Entries for Team Events	107
Grouping.....	107
Draw by Points	108
Mass Start in Points Order	108
Sprint Qualifications in Points Order.....	109
Relay Draw	109
Pursuit-Start Race.....	109
Bib Allocation	109

Bib Picking for Distribution – All Formats	110
Bib Picking – Mass Start, Interval Start, Sprint Qualifier	111
Method 1.....	111
Method 2.....	112
Method 3.....	112
Club/Team Bib Sort	113
Leg Stickers:.....	113
Bib Picking – Relays	113
Bib Picking – Sprint Heats	113
Bib Picking – Leader Bibs (Nationals, NorAms, Provincial Cups)	114
Preparation of Lists and Forms	114
Race-Day Activities	115
Bib-Management	115
Protests	115
Sanctions	116
Unofficial Results	116
Official Results	116
Minutes of Meetings	116
Course Salting Notification	117
SECTION 12: COMPETITION SECRETARIAT OFFICIALS	118
Competition Secretary	118
Recording Secretary	120
Secretary to the Jury	120
Competition Office Manager	121
Race Office Assistants	121
Results Poster	122
Webmaster	122
Awards Co-ordinator	122
SECTION 13: TIMEKEEPING, SCORING AND RESULTS SYSTEMS	123
Introduction	123
Tools of the Timing Trade	123

Electronic Timers	123
Para Nordic Considerations.....	125
Finish Timing.....	125
Display Clocks	125
Start Clocks.....	126
Printing Timers	126
Headsets.....	127
Equipment Setup	127
Operation of Electronic Timing Equipment	128
Starting Procedures	128
Interval Starts	128
Mass/Relay Starts.....	129
Pursuit Starts – with a break	129
Sprint Heats.....	129
Finish-Line Procedures	130
Interval-Start Races	131
Mass/Relay and Pursuit-start Races.....	132
Sprint Heats.....	133
Camera Technology	133
Use of Standard Consumer Video Equipment.....	133
Video Camera Set-up Detail	134
Use of Photo-finish Equipment	134
Photo-finish Setup.....	135
Lap Times	135
Results Systems.....	135
Sprint-Qualification Round.....	136
Electronic Timing System Information Flow	137
SECTION 14: TIMEKEEPING AND SCORING OFFICIALS.....	138
Chief of Timekeeping, Scoring & Data Processing Officials	138
Chief of Start.....	138
Starter	138

Assistant Starter	139
Start Controller.....	139
Chart Steward.....	140
Start-Time Recorder	140
Chief of Primary Timing.....	140
Finish Referee.....	141
Electronic Technician.....	142
Runners – Primary and Backup Timing.....	142
Chief of Backup Timing	145
Timer Operator – Printing Timer	145
Computer Operator.....	146
Lap Timing	146
Announcer	146
Announcer’s Assistant(s)	148
Awards Results Compiler	148
SECTION 15: COMPETITION SECURITY	150
Security Organization & Practice.....	150
Chief of Competition Security	150
Chief of Course Marshals	151
Chief of Stadium Marshals	152
Manager of On-course Transportation	153
Manager of Team Rooms (Waxing Area)	154
SECTION 16: SAFETY, MEDICAL SERVICES AND DOPING CONTROL	155
Introduction	155
Competition Safety.....	155
Chief of Medical Services	156
Clinic Staff.....	156
First-Aid Attendants.....	157
Concussion	157
Doping Control	158

Chief of Doping Control.....	158
Stewards.....	159
Registrar	159
Assistants:.....	160
SECTION 17: COMMUNICATIONS.....	161
The Requirement.....	161
Major Race	161
Low-key race.....	162
Radio Allocation, Distribution and Retrieval	162
Potential for Newer Technologies	162
APPENDIX 1 – EQUIPMENT LISTS	163
Course Equipment	163
Stadium Equipment	164
Timekeeping Equipment	165
Security & Medical Equipment.....	166
Competition Office Equipment.....	167
APPENDIX 2 – OFFICIALS LISTS	168
Chiefs Committee	168
Course Officials.....	169
Competition Secretary Officials.....	170
Stadium Officials.....	171
Timekeeping, Scoring & Data Processing Officials	172
Other Officials.....	174
APPENDIX 3 – PLANNING CHECKLISTS.....	175
Chief of Competition - Race Day.....	175
Chief of Course – Official Training Day	176
Chief of Course – Race Day.....	177
Chief of Competition Control – Race Day.....	178
Chief of Stadium - Official Training Day	179
Chief of Stadium - Race Day	180
Chief of Timekeeping, Scoring & Data Processing - Race Day	181
Sample Race Schedule – Interval Start	182

Sample Race Schedule – Mass Start	183
APPENDIX 4 – COMPETITION SECRETARIAT FORMS	184
Race Notice Contents.....	184
Suggested Registration Information for web	185
Sample Agenda – Team Captains’ Meeting.....	186
Sample Confirmation List	187
Canadian Sanction Form	188
FIS Sanction Form	189
Canadian Protest Form	190
FIS Protest Form	191
Accident Report Form	192
Pre-competition Medication/Drug Use form	199
Bib Bag Sheet Example.....	200
Leg Number Instructions	201
Bib pick list sample	202
Sample Leader Bib List for Timers	203
Relay Declaration Form Example.....	204
Team Sprint Substitutions Example.....	205
Team Relay Substitutions Example.....	206
Sample Notification of Withdrawal	207
Sample Clipboard/Forms Request	208
Sample Radio Sign Out.....	209
Course-Salting Disclaimer	210
APPENDIX 5 – TIMING AND SCORING FORMS & REPORTS	211
Start List Formatted as Start-Time Record – Z4 Legacy Program	211
Lane Assignments – Mass-Start Chevron – Racers View	213
Lane Assignments – Mass-Start Chevron – Starters View	214
Sprints – ORDER OF FINISH BY LANE.....	215
Sprints – BIB ORDER OF FINISH IN LANE	216
Sprints – Consolidated Lane & Bib Order.....	217
APPENDIX 6 – COMPETITION CONTROL FORMS.....	218
Bib Order Form	218
Lap Count Form	219

Controller Form – Obstruction & Other Violations	220
Controller Form – Technique Violation.....	221
APPENDIX 7 – COURSE FORMS/MAPS ETC.	222
Temperature Record	222
Course Map and Profile.....	223
APPENDIX 8 – PARA NORDIC COMPETITIONS	224
Paralympic versus Olympic Nordic Skiing	224
Classification of Athletes.....	224
Percentage system.....	225
Timing & Results	226
Wheelchair accessibility and facilities	226
Specific technical WPNS rules	227
Competition courses	228
Guide Bibs	228
Equipment: Special Rules for Sit Skiers.....	228
Homologation of Courses for Para Nordic Skiing	228
Stadium Layout.....	229
APPENDIX 9 – START LISTS AND RESULTS	230
Start List – Interval Start – Z4 Web Based Program.....	230
Unofficial Results – Interval-Start Race – Z4 Legacy Program.....	231
Pursuit Race – 2nd Race Start List – Z4 Legacy Program.....	232
Pursuit Start List with Lane Assignments.....	233
Sprint Heat Bracket Result – Z4 Web Based Program	234
Sprint Race Final Result – Z4 Web Based Program.....	235
Relay Results – Z4 Legacy Program.....	236
APPENDIX 10 – ACRONYMS	237

SECTION 1: EVENT ORGANIZATION

To successfully plan and execute a cross country ski competition can involve as little as an afternoon's work on one extreme or up to four years of preparation, with ever-increasing intensity, on the latter. The size and complexity of the competition must be matched by time commitments and skills of the organizers.

Every event has a Competition Committee whose function is to run the competitions (races) in the event. This committee is headed by a Chief of Competition and is comprised of the major officials who manage the race site activities (e.g. Chief of Course, Chief of Stadium, Competition Secretary, Chief of Timekeeping and Data Processing, etc.), and their subordinate teams who help to prepare and run the competition. However, if a cross country ski competition includes activities and services that are not directly related to the competition, additional volunteers are necessary to co-ordinate these services. These volunteers do not necessarily have to have cross country ski experience. They contribute other skills such as language translation, financial management, or event marketing. It is these volunteers who ensure that the needs of the athletes, volunteers, sponsors, spectators, and media are looked after.

In a small competition, the Competition Committee simply adds additional positions as needed, such as Treasurer or Volunteer Co-ordinator. For higher-level cross country competitions of national calibre such as the Canada Winter Games, a separate Event Organizing Committee (EOC) is necessary. Then the Competition Committee becomes a function under the EOC and looks after the daily running of each race.

In addition to the Nordiq Canada officials' program, competition volunteers may take additional volunteer or competition management training available from a number of different divisional and national sources.

The Event Organizing Committee (EOC)

Chairperson/Manager

The Event Organizing Competition Chairperson is one of the first positions filled. Often as the competition's representative to outside groups such as sponsors, government, media, and Nordiq Canada, the Chairperson ensures that all aspects of the competition proceed through the planning stages and meet expected goals.

Duties:

- Recruit volunteers for other key EOC positions.
- Ensure financial goals are met.
- Serve as competition representative and spokesperson.
- Motivate and provide guidance for other EOC Chiefs.
- Choose a Chief of Competition.

Chairperson, Venue Planning and Services

The Chairperson of Venue Planning and Services is responsible for all the facilities that serve the public, media, volunteers, coaches, and participants. The goal is to provide a comfortable, safe, and efficient environment for all.

Duties:

- Co-ordinate competition accreditation, ensuring that all athletes/participants, coaches, media, volunteers, officials, and VIPs are properly identified. This identification process allows competition officials to control access to certain competition areas as well as to provide a safe and fair competition.
- Work with the Chief of Stadium and the Chief of Security to co-ordinate spectator services (parking, traffic control, venue security etc.).
- Develop a competition communications plan, enabling all key competition officials to communicate as necessary. Radios, cellular phones, and on-site phones/intercoms are a few of the equipment considerations.
- Arrange for additional festival facilities such as food and beverage services, washrooms, and souvenir sales areas if the competition size warrants it.
- Co-ordinate medical services including ski patrollers and clinic staff.
- Ensure that local requirements regarding toilet facilities are met.
- Obtain licensing for temporary facilities.

Chairperson, Athlete Services

If the competition involves a large number of athletes, or if the majority of participants are coming from out of town, various services need to be organized for them. Good communication with the athletes and coaches is essential from an information-gathering and dissemination standpoint, as well as being a means to make them feel that they are indeed welcome and are valued guests.

Duties:

- Compile registration packages, including such items as maps of the area, calendar of competitions, key contacts, local information, pins, sponsor giveaways, competition souvenir items.
- Arrange for an official competition hotel and/or offer different choices of accommodation depending on the budget.
- Arrange for off-race-site waxing facilities.
- Arrange local tours during off-race times and access to local recreation facilities.
- Arrange meals on competition day.
- Arrange transportation from the airport, to and from the site, if necessary.
- Arrange for key team contacts, usually someone who is proficient in the language of a particular team.

Chairperson, Protocol and Hospitality

An event, unlike a competition, often has several ceremonial functions that are part of the making the competition a memorable experience for all those that participate. Provincial and Canada Winter Games often have opening and closing ceremonies, for example, giving the host site an opportunity to showcase local talent and celebrate the uniqueness of their area.

It is customary for multi-day competitions to offer a banquet, where the accomplishments of the athletes can be acknowledged, and thanks can be given to the volunteers and sponsors. Also, awards can be presented at the banquet instead of at the site after each competition.

Duties:

- Co-ordinate the opening and closing ceremonies.
- Arrange for competition awards (i.e. medals, gifts, cash).
- Co-ordinate the awards presentations.
- Organize a banquet.
- Co-ordinate hospitality services (coaches' meetings, special functions).
- Co-ordinate VIP services.

Chairperson, Finance

The Treasurer is responsible for the financial management of the competition.

Duties:

- Establish accountable bookkeeping systems, including a separate competition bank account.
- Produce regular financial statements for review by the EOC.
- Ensure proper sanctioning (Division office, Nordiq Canada, FIS) is attained if required.
- Prepare and monitor the competition budget.
- Provide various supporting agencies (i.e. government, Nordiq Canada or sponsors) with reports as required.

Chairperson, Marketing and Communications

The marketing portfolio is one of the most important areas in a competition, and yet is often one of the most neglected. The successful marketing of the various components that make up a competition can mean the difference between a financially-viable competition and a long-term debt for a club. A challenge for organizers is finding the necessary funds to run the competition. With a bit of imagination and some hard work, competitions can successfully involve sponsors and supporters in all aspects of its operation. Contributions can be monetary; but may also be goods-in-kind - items that are needed for the competition that you would normally have to buy.

Successful competition marketing involves a 'Give-to-Get' philosophy; providing your sponsor value for their contribution. One popular provision is ensuring that the sponsor receives maximum media coverage in the locales in which the sponsor does business. Establishing a comprehensive promotions campaign is also important for ensuring that athletes receive recognition for their results. The

communications and promotion tasks are often set up as a separate Chair position for larger competitions that have extensive media and sponsor promotion involvement: i.e. Chair of Communications and Media Services.

Duties:

- Co-ordinate fund-raising and marketing efforts.
- Provide pre-competition and on-site services to media (press centre, timely results filing, opportunities to interview athletes, press releases).
- Advertise the competition.
- Co-ordinate competition communication.

Volunteer Co-ordinator

The Volunteer Co-ordinator, (and assistants if required), has the responsibility to recruit and inform the volunteers. The commitment of volunteers can sometimes involve up to a four-year preparation period leading up to a competition. In light of this, keeping members of the volunteer sector motivated and enthused about their jobs is vital. Communication plays an important role both leading up to the competition and during the competition itself. Informed volunteers perform their jobs better and enjoy the experience more. It is important when choosing volunteers to think carefully about whether the job suits the skills, interests and ambitions of the individual.

Rewards for the time and effort spent by volunteers are an important consideration when budgeting for a competition. You cannot pay volunteers, nor do they expect to be paid. However, rewards, such as lunches supplied on competition day, free banquet tickets, pins, jackets or toques (if sponsored), go a long way to making volunteers feel their efforts are appreciated.

In cross country ski competitions, the Volunteer Co-ordinator may work in a staff position as part of the Event Organizing Committee or with the Chief of Competition in the Competition Committee. In competitions where cross country skiing is one of a number of different sports participating, such as during a Winter Games competition, the Volunteer Co-ordinator works with the Competition Committee developing the officials team for the cross country skiing section. In competitions where cross country skiing is the only sport, the Volunteer Co-ordinator works as part of the Event Organizing Committee and with all of the volunteers and officials working on the competition, e.g. a Divisional or National Championships.

Duties:

Pre-race:

- Recruit new and experienced volunteers.
- Organize officials' training clinics in collaboration with the Chief of Competition.
- Plan volunteer check in and the volunteer centre.
- Organize and co-ordinate group transportation to the site and accommodation if required.
- Prepare volunteer and officials lists for each competition Chief and Chairperson.
- Distribute accreditation to volunteers.
- Organize information/team meetings to bring volunteers up to date, and to promote involvement and team spirit.

- Prepare and distribute a volunteer newsletter regularly.

During Race:

- Set up for check-in and volunteer centre.
- Check attendance of officials arriving on site.
- Notify appropriate Chief or Chairperson of volunteer shortage and assist with job re-assignment.
- Direct officials to their area of assignment or to respective Chief.
- Distribute lunch tickets or lunches, banquet tickets, etc.
- Distribute miscellaneous small equipment to officials, e.g. clipboards, start lists, course maps, pencils, etc.
- Distribute any last-minute information, e.g. race delays, transportation changes, etc.

Post-race:

- Collect equipment distributed.
- Express a warm “thank you” to each volunteer and distribute any post-race information.
- Dismantle the volunteer centre.

Equipment:

- Personal computer, check in/out lists, tables, pencils, clipboards, radio, items for distribution to volunteers.

Procedures:

The Volunteer Co-ordinator adds value to the Event Organizing and Competition Committees by pulling the volunteers together as a team. In the build-up to a competition, the various Chiefs and Chairpersons focus on details surrounding their areas of responsibility without having to do training and recruitment which is the focus of the volunteer committee. The Volunteer Co-ordinator works with each Chief to identify his/her people requirements and the training needs of each; and assists with a recruitment and training program which focuses on all committees. Once trained, officials may be encouraged to work in a variety of areas to maintain their interest and to better understand each of their roles and how they relate to other officials’ duties. Moving officials around develops a more flexible team.

A list of all volunteers and officials that notes their email addresses, telephone numbers and job assignments should be developed. From this list, individual committee and check-in lists are prepared for the various Chiefs and/or Chairpersons.

A well-maintained part of the Event web site dedicated to volunteers, with information on up-and-coming competitions, the latest happenings in the committees, details about the race (e.g. what leading/top racers are coming) and meeting notices etc., keeps the volunteers interested and looking forward to coming activities. Any chance for volunteers to be brought together and meet one another prior to the competition will also create an atmosphere of involvement and enthusiasm.

Thank-you gifts should be distributed to the volunteers, and the Volunteer Co-ordinator often assists with organizing any post-race activity to thank or recognize the volunteers. The welfare of the volunteers

and officials is the job of the Volunteer Co-ordinator. If done well, volunteers will enjoy their experience and be willing to help in the future.

Event Organization Chart

The chart that follows is appropriate for Canada Cup, Regional Championships, Canada Winter Games and National Championships.

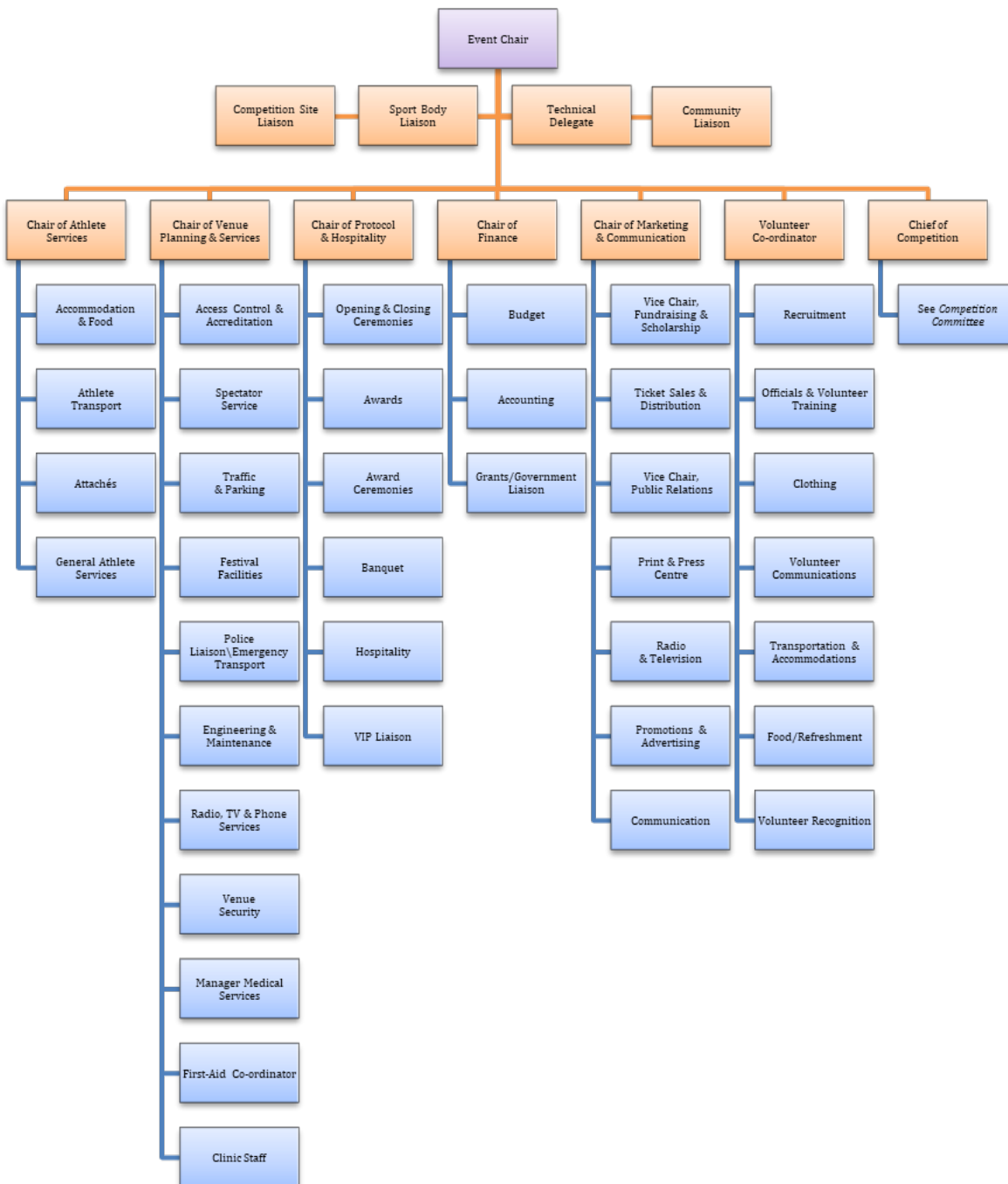

SECTION 2: THE COMPETITION COMMITTEE

The Competition Committee is comprised of all the “major officials” who manage the race-site activities, and of their subordinate teams which help to prepare and run the competition. The major officials represent the top tier of this structure and are the leadership team led by the Chief of Competition. The Committee includes:

- the Chief of Course;
- the Chief of Competition Control;
- the Chief of Stadium;
- the Chief of Timekeeping and Data Processing; and
- the Competition Secretary.
- the Chief of Competition Security may also be a member of this leadership team in large, high-level competitions.
- At the discretion of the Chief of Competition, the Competition Committee can be expanded to include others. This group acts as an executive to discuss interrelated problems between their respective areas of responsibility. The Competition Committee organization diagrammed on the following page is typical for our National Championships. Lower-level competitions may be served by a less complex organization.

The Competition Committee organization chart is designed to identify major tasks and official positions. Some tasks may require an individual official's attention at one level, but these same tasks may be managed by another official in a lower level competition, or in fact may not be needed. These organization charts present a good plan for organizing an appropriate Competition Committee and have been proven to work over many different levels of competitions.

Responsibilities of the Competition Committee

Prior to the competition, the Competition Committee:

- ensures that the race site is prepared, beginning the summer before the competition is to be run;
- ensures that the courses that are going to be used are properly cleared, widened, and/or bridged where necessary; and that curves are sloped and supported properly so that snow grooming can be carried out successfully;
- ensures homologation of the courses when required;
- selects those people who will fill positions of responsibility within each of the functional race areas;
- ensures that adequate training of the officials has been (or will be) carried out, including any dress rehearsals if needed; and
- decides on the pre-competition races that will be used as dress rehearsals.

Competition Committee Organizational Chart

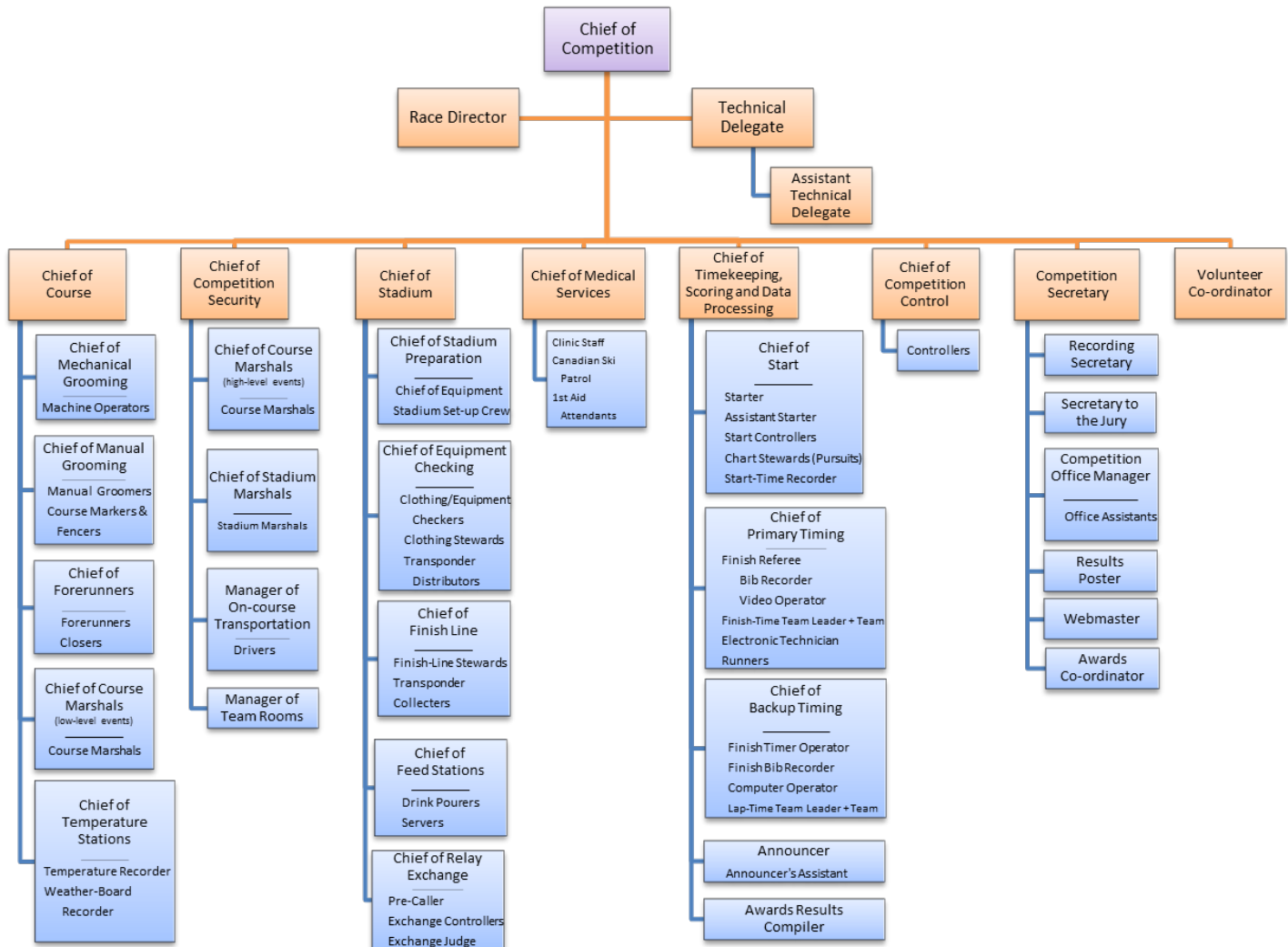

Chief of Competition

Reports to Chairperson - Event Organizing Committee

Oversees the work of the:

- Chief of Course
- Chief Competition Security
- Chief of Stadium
- Chief of Timekeeping, Scoring and Data Processing
- Chief of Competition Control

- Competition Secretary
- All other officials indirectly

Duties:

Pre-race:

- Sit as a member of the Event Organizing Committee and represents the interests of the Competition Committee to the Event Organizing Committee (when one exists).
- Structure and train a Competition Committee suited to the competition.
- Ensure that adequate training of the officials has been (or will be) carried out, including a pre-competition “dress rehearsal”.
- Establish and maintain liaison with the Technical Delegate, keeping the TD informed of the preparation of the competition if necessary.
- Assist with arranging for any accommodation and transportation needs of the TD to be met (billeting is acceptable).
- Plan the course and stadium layout with the Chief of Course and the Chief of Stadium.
- Supervise and co-ordinate the major officials in areas of budget spending, equipment acquisition, facility development, and communications.
- Develop a “timeline” schedule of all activities with the major officials.
- Evaluate, weekly or bi-weekly, the progress of major officials in relation to their timelines.
- Acquire current policies, rules and regulations, etc. applicable to the competition and disseminate them to the Chiefs.
- Provide or approve all technical information contained in race correspondence such as the race web site, race notices, entry forms, etc.
- Establish the date and time of the first team captains’ meeting with the Competition Secretary.
- Report progress to the TD and Assistant TD through minutes of Competition Committee meetings, competition details, course maps, and race information literature.
- Arrange for site visits and inspections by the TD and Assistant TD, if required.
- Provide a practice race (“dress rehearsal”), utilizing all officials in their appropriate positions. This is standard procedure for major competitions or for races held at new locations.
- Set the agendas and chair the Team Captains’ Meetings, including the draw.

During Race:

- Check that all officials and equipment are in place and functioning.
- Assemble the Jury at the TD’s request.
- Serve on Jury.
- Supervise the entire race from a strategic position.
- Maintain close communication with the TD and all major chiefs.

Post-race:

- Ensure that all officials have fulfilled their duties prior to leaving the race site.
- Evaluate race-day activities with the TD.
- Provide the TD with a complete set of results and minutes of Team Captains' and Jury meetings.
- Implement changes and preparations for subsequent days of racing.
- Conduct debriefing session with officials and compile a report.
- Provide feedback and thanks to all involved.

Qualifications:

The Chief of Competition must have:

- extensive experience as a major official (it is suggested that this person be at least a Level 2 official);
- good organizational, management, and delegation skills;
- high personal-performance standards;
- the ability to motivate others to work collectively; and
- a thorough understanding of the applicable rules and regulations.

Equipment:

- clipboard, start list, radio, watch, officials list

Method of Performing Duties:

As the above list of duties suggests, many of the tasks which confront a Chief of Competition are managerial in nature and take place before the race day. The Chief of Competition is the only member of the Competition Committee who has formal responsibilities to the Event Organizing Committee (EOC), and he/she represents the interests of the Competition Committee to the EOC. This position on the Organizing Committee entails responsibilities in the areas of Competition Committee budget, race execution, site development, and Competition Committee communications.

With this in mind, the Chief of Competition should take great care at the outset to plan carefully. The responsibility of being informed and knowledgeable requires an effort on his/her part. Training for this position should involve participation in formal officials training courses; and could be further enhanced by visiting other competitions of equal or higher calibre as an observer.

With a solid understanding of the organization processes and of the detailed tasks required of other major officials, the Chief of Competition must form a Competition Committee in which people are selected and placed in positions suitable to their individual strengths. Consideration must be given to experience, training, personalities, and commitment when assigning the major officiating positions on the committee. A hard-working homogeneous group of major officials represents the first step towards a successful competition.

Once the major positions (those whom the Chief of Competition supervises directly, along with perhaps a few other that are very specialized) have been assigned, the Chief of Competition sets out a general timeline of activities. The Competition Committee works out the details and produces a task-specific timeline for each of the areas under each major official. This process leads to the setting of budgets, site selection, planning, and the establishment of the level of sophistication the competition will seek to achieve.

When these details have been determined, approved by the Competition Committee, and agreed to by the respective chiefs, the Chief of Competition delegates the accomplishment of these tasks to each appropriate Chief, and then adopts a supervisory role to each major area. Regular meetings (approximately every 3-4 weeks, and more often as it gets closer to the competition date) are called where each Chief reports on progress to-date, overdue items not yet accomplished, and items that are slated for completion during the next month or so. Through these meetings, all members of the Competition Committee will be abreast of the progress being made, or the lack of progress (which is very important information to know). Remember that the Chiefs are volunteers, and generally have full-time jobs and families, so getting them to plan ahead and encouraging them to accomplish the tasks according to those plans may take some tact, encouragement, and perhaps even some assistance from the Chief of Competition.

The Chief of Competition develops the agendas and chairs the Team Captains' Meetings. This aspect must be planned and carried out with rigour, as this is the place where important information is disseminated to Team Captains/Coaches and is thereby passed on to the competitors; so, it has to be correct and complete.

Immediately before and during the competition, the Chief of Competition is primarily involved in supervising and troubleshooting. This Chief must always be on the look-out for potential problems and implement the necessary precautions or changes where required. In order to keep control and coordinate the race site activities, the Chief of Competition must be well-versed in all the plans and activities of the other major officials. Through the Chief of Competition, the major officials support one another in a common and team effort.

The Chief of Competition, as an advocate of the Competition Committee, is an influential member of the Jury and, in the absence of a TD, the Jury's spokesperson. (Keep in mind that in some instances, the Chief of Competition and/or the Jury cannot necessarily satisfy everyone.)

As a priority, the Chief of Competition must remember that the race is for the skiers and no one else.

The competitors' abilities, safety, and needs must be given the highest priority in reaching any decision.

The Chief of Competition remains in close liaison with the TD throughout the competition. The TD can be his/her best source of information about potential problem areas. If the TD and Chief of Competition are physically apart for a period of time, they should maintain contact through radio communications.

Post-race activities provide the Chief of Competition and other major officials the opportunity to reflect and evaluate their performance, and to make changes where, and if, necessary. The documentation from these sessions can be extremely valuable to future race organizers in the region. Digesting previous race-committee reports is an excellent way to prepare oneself as a Chief of Competition.

Technical Delegate

Reports to the EOC and Competition Committee

The Technical Delegate (TD) is the representative of the sport governing body to the Event Organizing Committee and the Competition Committee and is a guarantor for the competition sanctioning body (e.g., FIS, Nordiq Canada, its Divisions, etc.) that the competition is technically in accordance with the FIS or Canadian rules. The TD is responsible for organizing the work of the Jury. The TD must advise and assist the organizers in a helpful manner to conduct a **safe** and **fair** competition. The TD is not there to run the race but to help the organizers and officials to run a good competition. See also **ICR_CCR Rule 303** for more information on the role of the TD.

To accomplish the above, TDs will:

- help the organizers prepare for and carry out a quality competition;
- promote basic standards in competition organization;
- officially represent the sport governing body that sanctioned the competition;
- uphold and interpret the rules and policies governing the competition;
- provide a detailed and constructive critique of the competition; and
- remain absolutely neutral.

TDs are qualified officials who have considerable experience in running cross country ski competitions and have taken a Level 3, 4, or 5 TD course. They have wide and detailed experience in organizing and running competitions, are active in the sport, and are provided with up-to-date information, all of which allows them help organizers do a better job. In Nordiq Canada and the Divisions, we encourage organizers to view TDs as a resource to help them organize competitions in the latest and most effective way. This continuity helps to make the job of organizing and running a competition easier and more pleasurable and allows our ski racers to know what to expect with respect to proper and current race formats, stadium layouts, course design, preparations, and final results, etc. The first two goals stated above are considered very important.

Nomination of a TD (and sometimes an Assistant TD):

- For Nationally-sanctioned competitions, the TDs are appointed by the Events Committee of Nordiq Canada.
- For Division-sanctioned competitions, the TDs are appointed by the Division.
- The sport governing body which appoints the TD is also responsible to notify the Event Organizing Committee (EOC) of the appointment as soon as it has been confirmed. In the official notification, the sport governing body must provide the name, address, email address, and telephone number of the TD.

Duties of a Technical Delegate:

Pre-competition organization and course preparation:

- Establish contact with the Chief of Competition as soon as possible.
- Request minutes of Competition Committee (CC) meetings, copies of draft race notices, invitations and course maps.
- Approve the race notice.

- Review the official organization chart and advise on suitability of the volunteer numbers planned and training requirements. Request the names of the Event Organizing Committee and/or the Competition Committee members.
- For a major competition, it is advisable to conduct a conference call with the co-operation of the Chief of Competition to review with the Chiefs how they will deliver the event to comply with the Technical Package and/or Rules.
- Schedule site visits if required or requested. If a site visit occurs, try to meet as many of the senior officials as possible. If a site visit is not possible, then consultation with each of the Chiefs as described in the preceding point becomes very important.
- inspect the course, warm up area, wax testing area, and stadium layout, especially for major competitions, new sites, and new event- and/or competition-organizing committees.
- Review participant transportation and accommodation plans.
- Review homologation of selected courses and their suitability for the races scheduled. i.e. course lengths, profiles, difficulty, etc.
- Review course and stadium preparation and operating equipment needs including course marking.

Upon arrival for the competition:

- Meet with the Competition Committee, especially the Chief of Competition, Chief of Course, and Chief of Stadium.
- Ski the course(s), preferably with the Chief of Course.
- Review the course-grooming and track-setting requirements and the course-marking plans and signs.
- Decide, in collaboration with the Chief of Competition and Chief of Course, when the course shall be prepared, the optimal line, width of track, and safety precautions, as well as closure times.
- Evaluate the medical services on and off the course.
- Tour the entire stadium area including timekeeping, competition office, ski waxing area, etc.
- Meet with some of the coaches and determine if the site is ready as far as they can tell. Since Juries are now constituted, in some circumstances, with no coaches' representation, it is imperative that contact be maintained with them through periodic visits at their team rooms.
- Meet with the Chief of Timing to review procedures and equipment deployment, and in particular examine the planned use of any video equipment.
- Meet with the Competition Secretary and the Chief of Competition to review the Team Captains' Meeting room and agenda.
- Attend the Team Captains' Meeting and draw.
- Address the Team Captains' Meeting, review any special circumstances or rules, and introduce the Jury.
- Chair all Jury meetings and vote only to break ties.
- Set race-day Jury duties and meeting times with the Jury.

During the competition:

- Arrive at the race site at least two hours prior to the start of the competition, or earlier if weather conditions are difficult.

- Obtain a radio to remain in contact with the major officials.
- Ski (inspect) the course(s) and inspect the stadium area; where changes are required, arrange with the Chief of Competition to make them.
- Meet with the Jury at least one hour prior to the scheduled start of competition to confirm the start time, and to review any Jury members' concerns.
- Check with some coaches to identify any problems they know of that need attention before the race start.
- Review with the Assistant TD (if there is one) his/her duties and responsibilities; and any special places or activities that the TD would like to have observed.
- Observe: equipment inspection (if required); start procedures; finish-line activity; timekeeping; information flow; announcing; and after-care of skiers.
- Stay in the stadium area, normally.
- Remain in radio contact with the Chief of Competition, Chief of Course, and Chief of Timekeeping.
- Be on hand near the finish line to observe any close finishes in mass and pursuit starts.
- Meet with the Jury after the race to review any infractions, protests and unofficial results. Even if there are no infractions or protests, the Jury may have some feedback to provide on aspects of the race that should be communicated to the Chief of Competition for action in future races.
- Sign off on officials results.
- Sign off on the minutes of the Jury and Team Captains' meetings.

Post competition:

- Review the race with competition chiefs.
- Seek input from coaches and competitors for race assessment.
- Attend any banquet or end-of-competition activities and, if requested, make a speech. At the banquet, the TD is considered the representative of the sport governing body and should be seated accordingly.
- Write a detailed report on the preparation, organization and conduct of the competition (the Technical Delegate's Report). Send copies to the EOC and the sport governing body.
- If a disqualification or sanction has occurred, provide quality documentation to the sport governing body sufficient for the appeal process.

The Technical Delegate's Reports

After each event, the TD should prepare a report to provide **well-balanced, constructive feedback** to the competition organizers on how well they did, where they did or did not do well, where and how they could improve, suggestions concerning changes to be recommended to any of the sport-sanctioning organizations, and descriptions of the facilities. The report form for Nordiq Canada Tier 1 and 2 events can be found as a Microsoft Word form on the Nordiq Canada web site in the [document centre](#). FIS-sanctioned events require the completion of an FIS TD Report found on at <https://www.fis-ski.com/en/inside-fis/document-library/cross-country-documents> under Forms; as well as a Timing Report, usually delegated to the Nordiq Canada Race Director. Information for that report can be found at <https://www.fis-ski.com/en/inside-fis/document-library/timing-data>

The Jury

The Jury is the governing body, established at each competition, responsible for ensuring that the competition is organized and carried out according to FIS and/or Canadian rules. In addition, while adhering to the rules, the Jury may affect minor modifications to the rules providing the word “must” has not been used in formulating the rule. The issues which give juries much concern are weather (both hot and cold), and course preparation and safety. Decisions around these issues may result in course changes or postponement or cancellation of the competition.

The composition of the Jury is governed by **ICR/CCR Rule 303.1**. For FIS-sanctioned competitions, (e.g. NorAms and National Championships), the Jury is composed of the TD, who is the chairperson of the Jury; the Chief of Competition; the Nordiq Canada Race Director; and an Assistant TD. In Canada, our National Championships are FIS sanctioned and fall under this same definition for all categories. For other Nordiq Canada-sanctioned events, the jury may consist of the TD, the Chief of Competition, and a Visiting Team Coach. However, these rules do change over time, so it is best to refer to the Technical Package for the event for current definitions.

The sport governing body is represented by the Technical Delegate. It is usually the TD who will set out the “legal” framework and possible alternative actions, based on the rules, against which the Jury members will consider any items brought to their attention, since the TD is usually the most knowledgeable person on the Jury with respect to the rules. All members of the Jury have voting rights and decisions are made by a simple majority. The TD does not vote except in the event of a tie among the other Jury members.

The Jury may invite non-voting participants such as the Chief of Competition Control, Controllers, or the Chief Medical Officer, to act as professional advisers or to provide support services. Athletes named in a protest also have the right to be heard if they wish, or if the Jury wishes to hear from these athletes to obtain a more complete picture of the events surrounding a protest or incident. Minutes must be taken at all Jury meetings. Juries meet immediately after the Team Captains’ meeting, if required, one hour before the race start and after the race finish. Special meetings to consider extraordinary circumstances such as sudden weather changes, appeal hearings, or emergencies may also be called at any time. Remember that the Jury, not the TD, is the main deciding body at the competition site and so must be prepared to meet to solve any problems that arise. However, it is often the TD who will announce/publicize any decisions taken by the Jury.

Specific responsibilities and rules of the Jury are referenced in **ICR-CCR Rule 303.2**.

Probably the most common decision required of a Jury is whether to hold a race when the temperature is below the lowest threshold stated in the rules. For Olympic-style competitions, **ICR/CCR Rule 315.9*** states that if the temperature is below -20 degrees Celsius ($^{\circ}\text{C}$), measured at the coldest point of the course (-25°C in **ICR/CCR Rule 388.3** for Popular competitions), a competition will be postponed or cancelled by the Jury. It goes on to say that if there are difficult weather conditions, the Jury may, in consultation with the team leaders and the doctor responsible to the competition, postpone or cancel the competition. Nordiq Canada further requires that the -20°C limit be for competitions equal to or below 15 km; whereas, for competitions greater than 15 km, the Jury must postpone or cancel the competition if the temperature is below -18°C . Athletes under 12 years of age may not race if the temperature is below -15°C .

Now, we all know that skiers come to competitions to race, and officials do all the preparation and setup of the race site in order to hold a race, so they usually hate to have a race cancelled. However, the rule book has put the “stake in the ground”, and -20°C means just that, not around -20°C (such as -21°C or -22°C). Serious health concerns can easily arise below -20°C (such as hypothermia, and lung damage from rapidly breathing the very cold air during a race). It is not a pleasant decision to have to make, but it must be made and done according to the rules. Otherwise, it is possible for the TD and the Jury to be held liable for any injury that might occur during the race to any of the competitors, coaches, or officials due to the extremely-cold weather. Also, the TD and Jury may get some pressure from special interest groups (e.g., TV) not to cancel a race, but Jury members must be extremely careful how they handle the issue to make the proper decision. Competitors and their entourage expect a fair and safe competition, and the TD and Jury must do everything that they can to ensure that it is safe, and fair.

Protests

A competitor who believes that he/she has been wronged, according to the Regulations, by another competitor, coach, official, or spectator has the right to file a protest stating their position and asking the Jury to take some remedial action against the person who did the wrong. According to **ICR/CCR Rule 361***, the Jury must consider a protest provided that it has been received within the time limit specified (see **ICR/CCR Rule 361*** for these time limits); that the protest has not been deliberately delayed to obtain an advantage; and that the protest is accompanied by a payment.

First, the Jury must consider all the facts of the situation and obtain as much evidence from as many credible sources as is reasonably possible. These sources may include other competitors, coaches, officials, videos, etc. The Jury should, however, remember that trying to review too much evidence can unduly delay the results of a competition and take away from the enjoyment of it. Therefore, before a competition, a Jury should decide what sources it will review so that it doesn't become burdened with too much evidence. For example, a Jury may not likely be able to find the time to review a dozen or so videos provided by spectators out on the course. Second, all of the possibly applicable rules should be reviewed. Third, the review should be kept impersonal, i.e. the names and/or personalities of competitors should not be revealed while the protest is under consideration, since such information may cloud any decision.

If the Jury finds that a person has wronged someone else, or has done something against the rules, it must consider possible sanctions against that person. **ICR/CCR Rule 352*** sets out possible sanctions that may be issued, while **ICR/CCR Rules 223*** and **226*** set out sanctions in more detail, including who may be sanctioned. Sanctions may be given orally or in written form. **ICR/CCR Rule 224*** sets out the procedural guidelines surrounding sanctions, and **ICR/CCR Rule 225*** sets out the appeal process that a sanctioned person may follow if he/she wishes.

Protests during Sprint Competitions

In sprint competitions, due to the timeline pressure of running successive heats, it is not possible to allow protests during heats and semi-finals. Protests will only be accepted after the finals (as is the case in normal competitions). This implies that, as in all sporting events, trained officials (referees) make the difficult calls to the best of their ability and within the physical restrictions of the venue. So, the TD and the Jury will call it the way they see it. The fact that we already accept official video footage of incidents out on the course is more than is done in some other sports. (That process definitely comes at great expense in terms of the time delays and infrastructure needs.) We must accept that there will be

differences of opinion on judgement situations but that is part of sport and that is why officials' training is extremely important for some of the key positions.

Before a sprint competition begins, the TD should meet with the Jury to ensure that there is clarity on what constitutes obstruction to ensure consistency of application of the rules during the race. It should also meet to decide what evidence sources will be considered during the review of any protests. Such considerations may include only certain video cameras, certain officials on the course and in the stadium, certain expert resources that may be at the race, etc.

Through an evolution of the regulations since 2002, sanctioning is now done using the Decision Charts (https://assets.fis-ski.com/image/upload/v1541414927/fis-prod/Decision_Charts_Cross-Country.pdf) developed by the FIS. Evidence determines if the incident was a 'racing incident' or if some infraction occurred. In sprint races obstruction and interference may occur, but do not always constitute an infraction. If the jury considers that an infraction has taken place, it must then determine whether the incident was minor or major in its effect on other competitors. Sanctions can then vary from a verbal warning to a Competition Suspension (i.e. being placed last in a heat and not advancing).

During the sprint rounds the members of the Jury, other than the TD, will be positioned on the course. An extension of the jury to include other qualified officials may occur; with the number and their deployment being such that the whole course can be observed. Each Jury member should be teamed with a controller to assist in verifying and recording any infractions. After each heat round, the Jury members should be polled to determine if any problems need to be dealt with before the next heat. One Jury member should be at the finish line to communicate Jury decisions to a competitor.

SECTION 3: COMPETITION OFFICIALS PROGRAM

Officials Development

Cross Country Skiing is a dynamic and fast-changing sport. Change in all aspects of the sport has never been more rapid than in the 1980s when improved snow grooming and track setting paved the way for new technology in the design of cross country skis, leading to different ski techniques, increased racing speed and improved performance. Courses are now more demanding and faster, and this has led to homologation (design standards) of courses designed to establish competition standards and ensure ski-ability and safety. Roller Ski and Para Nordic skiing are becoming more mainstream. While differences will be highlighted, the processes and procedures used for both Para Nordic and summer roller-skiing events are essentially the same as we would use in winter cross country skiing.

We are now 35 years into the age of personal computers and with high-functioning portable computers now available, very few races at any level are run without them. As a result, just about any race should see accurate and timely results.

Races now have to be organized in a more professional manner demanding trained and informed officials and a basic, consistent race organization. The Officials Program for Cross Country Skiing has been developed and is maintained by volunteers on the Officials Committee of Nordiq Canada. The Officials Committee is part of the Events Committee. All levels of training now take advantage of modern Learning Management systems with online pre-seminar learning and post-seminar testing to enable certification. In fact, since 2017, Level 1 training has been available as an interactive online process in both official languages. As most high-level competitions held in Canada are sanctioned by the FIS (Fédération Internationale de Ski), the Nordiq Canada rule book is integrated with the FIS International Competition Rules (ICR). Specific Canadian rules are highlighted for use at Nordiq Canada-sanctioned events in the Canadian Competition Rules (CCR) - available online on the Nordiq Canada web site.

Race management systems have developed to the point where most races are online from the registration of competitors, through the management of timing and scoring at the races and culminating in the online publication of results.

This copy of Nordiq Canada Competition Officials' Handbook represents the fourth edition. It is an effort to address the many changes to the sport of cross country skiing since 1992. New race formats and start procedures have radically changed the required skill set of organizers. These changes are paralleled with the increased use of technologies to support timing and communications functions.

Classification of Officiating Roles

In contrast to many sports, cross country ski racing requires a large number of officials. The duties are extremely varied and often performed independent of one another. The tasks have differing degrees of complexity and responsibility associated with them. The distance separating officials on the field of play can easily be more than a kilometre. These factors place greater emphasis on the communication and co-ordination skills of the officials and on a need to understand how each job fits into the whole organization.

Adding to these differences are considerations imposed by the level of competition at which any specific duty will be performed. In all, organizing and officiating in cross country skiing implies a list of widely-diversified functions. To facilitate future discussions, officials will be classified into smaller groups characterized by their complexity and levels of responsibility.

Major Role

This category includes duties which require an in-depth knowledge of the rules and regulations and of race organization. The lines of communication, authority and responsibility must be understood. These positions require very good management skills.

- Chief of Competition
- Chief of Stadium
- Chief of Competition Control
- Chief of Course
- Competition Secretary
- Chief of Timekeeping, Scoring & Data Processing
- Chief of Competition Security
- Chief of Medical Services

Secondary Role

This category includes duties which require competence in their own single area of responsibility. A general knowledge of rules and regulations and of race organization is necessary. Positions in this group tend to be predominantly task oriented.

Some examples of secondary role positions are:

Assistant Chiefs to all Major Roles

- Chief of Start
- Chief of Stadium Preparation
- Chief of Mechanical Grooming

Individual Technical and Administrative Roles

These jobs generally involve the processing of information, the control and maintenance of the race site, and medical services. A minimal knowledge of rules and regulations and of race organization is necessary; however, these officials should understand the relative importance of their jobs to the overall success of the event.

- Start-Line Officials
- Finish-Line Officials
- Stadium Setup Crew
- Manual Course Groomers
- Temperature Station Personnel
- Medical Personnel and First Aid Attendants
- Runners

- Parking/Traffic Attendants
- Exchange Zone Judges and Controllers
- Forerunners and Course Closers
- Refreshment Station Personnel
- Announcer

Parking is not part of the competition, but is covered under the Event Organization.

Officials Certification

The officials' certification program is developed and co-ordinated by Nordiq Canada under the guidance of its Events Committee. Nordiq Canada has revamped its officials training program while at the same time providing a central registry for our officials. Registration is free - visit the [Officials Training Centre](#) on the Nordiq Canada web site. Level 1 and Level 2 officials training is managed by each Division, with the tasks normally assigned to a Divisional officials' co-ordinator. The curriculum and related PowerPoint presentation are prepared as national standards by the Events Committee and include online components and online registration for future course offerings across the country. Candidates for Level 3 officials training are recommended for advancement by Divisions and the training is co-ordinated by Nordiq Canada. Level 4 and 5 officials are recommended for training by the Nordiq Canada Events Committee within an apprenticeship model.

Level 1 and Level 2 training sessions are scheduled by each Nordiq Canada Division and individuals may attend out- of-province seminars if the host Division has space available. The cost for this training is determined by each Division. As previously mentioned, Level 1 Certification can be achieved through an online interactive course at no cost. Our online environment has the capacity to list all available courses being offered in the country. Participants can request to register online at the Nordiq Canada website under the Events tab.

Level 3 courses are normally delivered in conjunction with a national championships event over four days in order to provide the necessary variety of race format observations and post-race analysis. Level 3 certification qualifies officials to act in a major official role at national level competitions and/or act as a Technical Delegate (TD) at Divisional events. Nordiq Canada provides sufficient resources online that it is expected any official at Level 3 and above should be able to deliver Level 1 and Level 2 seminars.

Level 4 and Level 5 Technical Delegate training is strongly focused on practical assignments, learning and assessment at the national level and at FIS-sanctioned events under the supervision of a qualified TD.

Level 1 Official

A Level 1 official will be able to:

- perform all the duties of "individual technical and administrative officials" for Olympic and popular cross country ski (Loppet) competition;
- possess a general knowledge of the Cross Country Rules and Regulations; and
- possess a general knowledge of the Competition Committee structure for Olympic- and Loppet-type competitions.

Course Particulars:

Seminar based:

- Theoretical and practical training will be conducted in a one-day course.
- Course conductors will be assigned by the division's officials co-ordinator from their Level 3 and 4 officials.
- Registration is through the Officials Training Centre on the Nordiq Canada web site.
- Registrants will be accepted into the course by the Course Conductor (Instructor).
- Web-based pre-learning will be expected, and a pre-course test will be conducted on the structure and governance of our sport.

The course will cover:

- the overall Event Organizing Committee make-up and duties;
- the Competition Committee and organization;
- an overview of the different types of competitions and formats;
- specific areas and responsibilities in course preparation and track setting, stadium layout and grooming;
- the competition secretariat;
- timekeeping and results systems; and
- competition security and safety.

The course will include a demonstration of manual timing with mock race practice in start and finish procedures. Participants will be expected to acquire sufficient knowledge to be able to function as individual technical and administrative officials in low-level competitions under the direction of Level 2 and 3 officials. At an awareness level, participants are introduced to the key areas of risk management as it relates to cross country event hosting. Certification will be based on passing a post-course online test.

Online training:

The course is available to all participants at no cost by enrolling on the Nordiq Canada e-learning site.

It is structured in 8 sections:

- Cross Country Culture and Governance
- Organization and Key Positions
- Ski Techniques and Race Formats
- Competition Secretariat
- Course
- Stadium
- Timing and Results
- Regulations and Conduct during the Competition.

Each module should take approximately 40 minutes, but a student can set their own pace. There are tests after 6 of the sections, and the student must pass with a grade of 75% in order to proceed. On successful completion of the last test the student is informed they are certified, and an entry is made in the Nordiq Canada Officials Registry.

Prerequisites:

The course participants must have a desire to help run cross country skiing events, and a willingness to attend a training course to become a certified official. The recommended minimum age is 16 years.

Level 2 Official

Level 2 Official will be able to:

- perform all major, secondary and administrative duties for Olympic-type and popular cross country ski competitions at a divisional level and below;
- be a reliable witness if infractions occur;
- perform instructional sessions in “individual technical” duties;
- make organizational decisions which consider the needs of the athlete and of risk-management issues; and
- organize and officiate interval-start, pursuit, sprint, mass-start and relay competitions.

Course Particulars:

Theoretical training will be conducted during a two-day clinic which should incorporate a demonstration of electronic timekeeping and a mock-race practical session. Course conductors will be assigned by the division’s officials’ co-ordinator from their Level 3 and 4 officials. Registration is through the Officials Training Centre on the Nordiq Canada web site.

Course registrants will be accepted by the Course Conductor based on a review of their recorded experience on the Nordiq Canada Officials web site. A pre-course test will be conducted through the web site to ensure technical preparedness. Post-course certification will require completion of an online test.

Prerequisites:

The course participant must:

- have performed at least three different “secondary official” duties in sanctioned cross country ski events; and
- hold the Level 1 officials’ certification.

Re-certification:

Race formats have changed considerably in the last few years. As a result, Nordiq Canada requires that officials certified at Level 2 prior to January 2013 will need to re-certify in order to maintain Level 2 on the Nordiq Canada database.

Level 3 Official - Event Organizer

A Level 3 official will be able to:

- perform any “major official” role at the national-championship level and below;
- effectively structure, staff and manage a competition- and event-organizing committee at the division through to the national level;
- be familiar with the Nordiq Canada Regulations and Technical Packages and FIS rule book and make appropriate rule interpretations as they apply to Tier 1- and 2-level competitions;

- be able to provide a risk-management assessment for a race site and develop an effective risk management plan; and
- instruct the Level 1 and 2 officials' clinics after having achieved certification.

Course Particulars:

Theoretical training is conducted during a four-day clinic incorporating observation of a national-level or regional championship competition that covers at least 3 different race formats. Course conductors will be assigned by the Events Committee from Nordiq Canada. Certification will be based on passing a series of pre and post assignments and on the course conductor's recommendations.

Prerequisites:

The course participant must:

- be recommended by his/her division;
- complete all requirements of the Level 3 Officials course;
- have performed at least two different "major official" duties and at least three different "secondary official" duties at events at the division cup or national-championship (or equivalent) level (logbook documentation may be required); and
- hold a Level 2 officials' certification.

To maintain certification:

- Maintain an active interest by working as a major official in club and divisional events at last two of every three years.
- Certification will be reviewed and re-assessed every five years by the Nordiq Canada Event Committee.

Level 3 Official - Technical Delegate – Nordiq Canada Divisional TD

A Level 3 TD will be able to:

- perform the role of a Divisional Technical Delegate for events which require the overseeing and performing of all aspects of officiating at the division level for division cup and popular cross country ski (loppet) competitions; and
- perform all roles described for a Level 3 Event Organizer (above).

Course Particulars:

See Level 3 Event Organizer course above.

Prerequisites:

The course participant must:

- be recommended by his/her division;
- have performed at least two different "major official" duties and at least three different "secondary official" duties at events at the division cup or national championships (or equivalent) level (logbook documentation may be required); and
- hold Level 2 officials' certification.

Certification:

- Meet the prerequisite requirements of the Level 3 officials course.
- Complete all requirements of a Level 3 officials course.
- Complete one (1) divisional apprentice TD assignment or Jury-member role.
- Be an active skier, able to ski courses in both techniques and in a reasonable timeframe in order to inspect and assess the quality of the course preparation and track setting.

To maintain certification:

- Maintain active interest by working as an official and/or as a TD in club and divisional or provincial events two of every three years.
- Attend a Nordiq Canada TD, FIS TD or Division Level 3/TD update once every two years
- Be an active skier, able to ski courses in both techniques and in a reasonable timeframe in order to inspect and assess the quality of the course preparation and track setting.

Level 4 Technical Delegate - National TD

A Level 4 Technical Delegate will be able to:

- oversee the organization and officiating of national-level competitions with special emphasis on racecourse design and preparation, rules and policies unique to existing national competitions, and administrative responsibilities unique to existing national competitions;
- perform as a Technical Delegate for all levels of Olympic-type events sanctioned by Nordiq Canada or its divisions (below FIS Sanction);
- perform Assistant TD roles at FIS-sanctioned events in at least two locations, with one being outside your home division, and perform varied responsibilities assigned by the TD;
- demonstrate effective use of the FIS Jury Guidelines and decision-making process;
- perform “major official” duties at an international competition;
- effectively train Level 3 officials after having had Course Conductor’s Certification;
- make appropriate rule interpretations from the Nordiq Canada and FIS rule books as they apply to national-level competitions; and
- support the National Events Committee and its subcommittees on rules and regulations and officials’ development.

Qualification Particulars:

- Complete a National TD Assistant role and receive a successful evaluation as an Assistant TD or Apprentice TD at an FIS-sanctioned event (ATD - NORAM or Apprentice TD at National Championships).
- Have attended a Nordiq Canada/FIS TD Update within the last two years.
- Complete a TD Candidate Self Assessment & Certification Tracking template.
- Be recognised by the Nordiq Canada Events Committee.

Prerequisite:

The course participants must:

- be recommended for the course by the division's chairman or events committee;
- have served as a Divisional TD twice during the past two years and completed one National TD Assistant role;
- hold an active Level 3 officials' certificate; and
- be an active skier, able to ski courses in both techniques and in a reasonable timeframe in order to inspect and assess the quality of the course preparation and track setting.

To maintain certification:

- maintain active involvement with cross country skiing by working divisional-level events and regional- or national-sanctioned events when the opportunity arises;
- do at least one TD assignment of a Nordiq Canada- or FIS-sanctioned event every two years;
- enter these experiences in your experience log;
- participate in an annual Nordiq Canada fall TD/OC (webinar) updates at least once every two years;
- participate in an FIS TD regional seminar at least once every four years;
- maintain good skiing abilities and ski courses in both techniques; and
- have certification reviewed and re-certified every five years by the Nordiq Canada Events Committee.

Level 5 Technical Delegate - FIS TD

AN FIS Technical Delegate will be able to:

- oversee the organization and officiating of an FIS-sanctioned competition with the main emphasis being given to technical preparations and installations, and to oversee the administrative aspects of race organization that are unique to events of this magnitude;
- train officials at all levels with emphasis placed on Level 4 Technical Delegates;
- be involved in FIS committees relating to the cross country discipline; and
- perform as a Technical Delegate for all level of events anywhere in the world as appointed by FIS.

Qualification Particulars:

- Be recommended by the Nordiq Canada Events Committee TD Working Group to attend a first FIS TD seminar as a candidate.
- Be an experienced Chief of Competition or international-level athlete or coach involved at FIS-level competitions.
- Be an active Level 4 National TD working in various capacities at national and international-level events.
- Be an individual identified by FIS or the Events Committee for fast-tracking based on recognised skills and experience at FIS-level competitions.
- Have attended a Nordiq Canada/FIS TD Update within the last two2 years.
- Complete a TD Candidate Self Assessment & Certification Tracking template.

- Be recognised by the Nordiq Canada Events Committee.

Prerequisites:

The FIS TD candidate must:

- be capable of conducting meetings in English;
- be able to ski all types of courses in both techniques;
- be able to make independent decisions and to lead meetings;
- be active in CC Sport year-round. That may include popular cc skiing or roller skiing;
- be ready to accept at least two TD assignments during the season at national and international levels (FIS competition and higher levels); and
- have a profound knowledge of the ICR before attending an FIS seminar.

Certification:

- Attend an FIS Regional TD seminar. The seminar will include theoretical and practical training over a two- to three-day period and be organized by the FIS organization and regional TD coordinator.
- Complete an apprentice TD assignment and received an evaluation by an FIS TD at an FIS-sanctioned event.
- Successfully complete Part B assessment at a subsequent FIS TD seminar.
- Maintain good skiing abilities and be able to ski courses in both techniques and in a reasonable timeframe in order to inspect and assess the quality of the course preparation and track setting.

To maintain certification:

- Attend the FIS TD seminar every two years.

FIS Popular or Roller-Ski Qualification

FIS TDs may also qualify to supervise FIS popular and/or FIS roller-ski competitions. To acquire this qualification, FIS TDs must be actively involved in organizing and officiating at popular and roller-ski competitions and attend a popular and/or roller-ski module at an FIS TD seminar.

- Roller skiing: The Subcommittee for Roller Skiing can prepare a list of items for special Roller Skiing TD updates and organize specific TD updates.
- Popular skiing: The Subcommittee for Popular Skiing can prepare a list of items for special Popular Skiing TD updates and organize specific TD updates.

FIS World Cup TDs

The best and most experienced FIS TDs will be selected by the FIS for World Cup, World Championship and Olympic Winter Games assignments. All nominated World Cup TDs are invited to the FIS World Cup TD update in the autumn prior to each competition.

FIS has indicated a strong preference for recruiting former elite athletes or coaches into the world cup team and has a stated priority for achieving gender parity amongst this group. Competitive skiing skills and experience are a de-facto pre-requisite.

WPNS Technical Delegate

World Para Nordic Skiing (WPNS) Technical Delegates will be able to:

- oversee the organization and officiating of WPNS or Nordiq Canada Para Nordic-sanctioned competition in accordance with the rules, and with the main emphasis being given to technical preparations;
- oversee the administrative aspects of race organization that are unique to Para Nordic skiing events; and
- train officials at all levels in the specifics of Para Nordic competitions.

The three levels of Para Nordic TD recognition are:

- National PN TD
- WPNS TD Candidate
- Licensed WPNS TD

Qualification and certification:

Criteria can be found in the WPNS Guidelines for TD Education from the WPNS website. At the national level, candidates should be active Level 3 or Level 4 TDs and be active in Para Nordic cross country skiing or biathlon year-round - including in the organization of Para Nordic skiing events, coaching or officiating. More details can be found in the Self Assessment form on the Nordiq Canada website.

Role of the Official

From their position of objective impartiality, officials are charged with the following general responsibilities:

- to supervise and control the event in a manner which reflects the spirit and intent of the rules and regulations;
- to provide competitions which will preserve the health and safety of all involved;
- to guarantee that each competitor receives an equal and fair opportunity to win; and
- to promote sportsmanship and an atmosphere of enjoyment.

Being an Effective Official

This section represents the nuts and bolts of getting a good job done – the do's and don'ts of how to avoid the seemingly-inevitable frustrations that come with the tasks.

Ski competitions are for the skier: officials are present to guarantee that the rights of each competitor as stated in the rules and regulations will be upheld in the competition. Officials and the job of officiating should be as unobtrusive and inconspicuous as possible. You should assume your responsibilities in a manner which will earn you the respect and support of competitors, coaches and spectators.

Officials should respect the desire of each competitor to be considered a worthy participant. As officials, your personal views should not be voiced, and each individual effort from a competitor should be taken seriously. You must make any officiating duty a personal commitment as well as a commitment to your peers. This is easily reflected by your willingness to consult with others and by your effort to keep up to date with current rules and procedures.

Remember that you and everyone else officiating at a ski competition are volunteers! Everyone has probably adjusted other priorities in their lives to be there. Respect and support their efforts through a spirit of co-operation.

The overall success of the competition is dependent upon the performance of each individual. Accept an assignment to officiate only if you plan to honour the commitment. There are enough unpredictable situations built into our sport by Mother Nature that we do not need the added frustrations of “no shows”. Be on time for your assignment – this means that you are there before you are needed. Inform the appropriate major official if you are unable to attend or if you will be late. This must be done as early as possible, and if you are conscientious, you should aid in finding your own qualified replacement.

As an official, you must not be a coach to competitors. Encouragement may be given provided it is done equally for all. (For young competitors, it may be necessary to offer more guidance.)

Never accept an assignment you are not qualified to handle. Poor performance through ignorance can be harmful to the skier and will reflect poorly on you and the organizing club you represent.

Officials should respect the fact that last-minute changes will always be a possibility. Remaining flexible and adaptive in your thinking will enable the competition to continue to its successful conclusion.

Sport Governing Bodies

Fédération International de Ski (FIS)

The FIS is the international sport governing body for skiing, with its head office in Oberhofen, Switzerland. It has numerous policy and program committees which operate under each discipline of the sport. In addition, there are sub-committees within each discipline which co-ordinate areas of activity for that discipline. Nordiq Canada has active representation on various FIS Cross Country subcommittees. Nordiq Canada is officially represented to FIS as a National Sport Organization (NSO) through the Canadian Snowsports Association.

Nordiq Canada

Nordiq Canada is the national sport-governing body for cross country skiing in Canada. It is governed by a Board of Directors, elected by the Divisions. The Board, in turn, appoints an Executive Director who is responsible for the day-to-day running of the organization.

Nordiq Canada’s vision is “To inspire a nation to international excellence and podium success, health, and participation.” (Nordiq Canada, Strategic Plan to 2022(+), Page 4). To deliver on this mission, its mandate is: “Cross Country Ski de fond Canada is the national sport organization that works with member clubs, divisions, and other partners to co-ordinate and support the development of cross country skiing from introductory experience to international excellence through leadership, education, promotion, and training.” (Nordiq Canada, Strategic Plan to 2022(+), Page 4).

Sport governing bodies in general provide a framework through which programs can be developed, funding disbursed, standards established, and feedback received. The quality of support that these volunteer organizations can give to their athletes has a substantial effect on their overall success on the racecourse. Nordiq Canada has representation on, and works closely with, other sport-related bodies such as the Canadian Olympic Committee, The Canadian Paralympic Committee, the Canadian Snowsports Association, Sport Canada, Own the Podium-2010, and the Coaching Association of Canada.

The Divisions (the provinces and territories), through their member clubs, deliver the various programs developed by Nordiq Canada.

SECTION 4: SKI TECHNIQUES AND RACE FORMATS

Ski Techniques

There are a variety of techniques in cross country skiing, but they are all classified into 2 types: classical technique, and free technique.

Classical Technique

ICR-CCR Rule 310.2* defines the classical technique to include (and be limited to): diagonal, double poling, herringbone without a glide phase, downhill and turning techniques.

Turning techniques comprise steps and pushes in order to change direction. However, there is a fine line between turning techniques with steps and pushes, and skating. Similarly, regulators wish to preserve diagonal technique as opposed to double poling a whole course. As a result, the governing body continues to refine processes to enforce classical technique. These regulations are extremely important so course controllers should be familiar with them. In that way they can be reliable witnesses if the jury is assessing an infraction.

ICR-CCR Section 352.1* provides for a sanction for technique violation which may be issued, based solely on a decision of the Technical Delegate (TD) and one other Jury member – without video review and without any opportunity for a hearing.

Free Technique

ICR-CCR Rule 310.2* defines free technique to include all cross country skiing techniques. This technique can include all classical techniques. Please note that the correct term is NOT “free style technique”, but “free technique”.

Standing Para Nordic skiers compete in both classical and free techniques, but sit skiers only use double poling technique throughout (and thus always require classical track setting).

Roller-ski races are conducted in a very similar fashion to ski races on snow. One stipulation in the regulations is that for classical technique competitions, the roller skis must have a ratchet mechanism so diagonal stride can be achieved. Wheels and bearings are also regulated to ensure consistent ski speed for all competitors.

Individual Competitions

Interval-Start Competitions

(either Classical or Free Technique)

During an interval start, each skier starts at a given time, usually at 30-second intervals. The time interval between starting racers may be as short as 10 seconds, or as long as one minute. This is the fundamental individual-race format used in cross country skiing where competitors race against the clock. Each racer’s skiing time is calculated by subtracting the start time from the finish time to obtain the elapsed time; the one who wins is the one with the shortest elapsed time. Timing precision is regulated to 1/10 of a second achieved by truncation. This event is basically a time trial.

For interval-start competitions, it is customary to provide a “late-start lane” to accommodate racers who arrive late for their start. They are still permitted to start, and the late-start lane permits this to happen without interfering with other racers who are starting at their scheduled time. (See **Section 9** – [Stadium Layouts](#)).

Mass-Start Competitions

(either Classical or Free Technique)

This start format has become more common in recent years where skiers compete against each other as a group and the first skier across the finish line wins. In this type of start, the entire field/category/class of racers starts at one time, in parallel start lanes of about 100 meters in length. (See **Section 9** – [Stadium Layouts](#)). Therefore, there must be the correct number of start officials present at this type of race in order to ensure that each racer is in his/her proper starting position. Remember that all the racers in a class will be arriving at their start positions at the same time, so it can be mass confusion unless the starting officials are well prepared, have a map of the start grid for each category and know the proper procedures. A sample of a suitable map is found in Appendix 5-4. The fastest skiers are assigned positions on the first row, with the slower skiers being assigned starting lane positions in subsequent rows behind the first row of starters. This alignment creates a “chevron” appearance, and this start grid is in fact often referred to as “the chevron”.

Usually two minutes before the race start, starting instructions are given. At one minute before the start the “one-minute” warning is given, then 30 seconds before the start of the race, a “30-seconds” warning is announced to the racers. No other signal must be given until the start signal, or you will find that the racers try to anticipate the start signal and end up being over their start lines before the actual start signals. Should this happen, it may be necessary to call a false start, return the racers to their start lines, and re-start the race.

At the start signal, racers are required to double pole (or use diagonal technique in a classical race) to the end of the start lanes, at which time they may then proceed to race using the dictated technique. The first skier across the finish line for the category/class wins. This starting technique allows the competitors and spectators to know who is winning at any point in the race, and all competitors know whom they have to pass in order to win. Timing precision is the same as interval-start competitions.

In long-distance races skiers may be permitted by the Jury to change skis one or more times during the race. In such cases, the ski-exchange boxes must be located and designed in such a way as to ensure that skiers who choose to exchange skis do not ski any less distance than those who do not choose to exchange skis.

Pursuit Competitions

Pursuit competitions are carried out as combined competitions where the starting times of individual athletes are determined by results of previous competitions, and the final result is determined by the finish order at the last of these competitions.

One special type of pursuit competition is a “Pursuit Competition – With a Break”, which is usually a two-race series, conducted over two successive days, which provides a test of each skiers’ ability in both

classic and free technique styles, and creates an exciting start for the second race for the media and spectators.

The first race is an interval-start race (usually classical technique). From this first race, the time interval behind the winner is calculated for each skier and this becomes the time that each particular skier starts the second race (using a different technique from the first race) behind the winner of the first race. The time interval behind is truncated to one-second precision. This is referred to as a pursuit start.

For the pursuit start, three, four or five start lanes are used with a Starter and Assistant Starter for each lane. The first skier starts in lane #1 at time 0, with the second skier starting in lane #2 at his/her time interval behind the winner of the first day's race, and so on. If there are 4 lanes, then skier # 5 will start in lane #1 after skier #4 starts in lane #4. This pattern continues until all skiers have started. The number of start lanes should be determined by the number of skiers starting at the same time after their first race times have been truncated. The winner is the first skier to cross the finish line at the end of the second race.

The logic behind this type of race is that a skier who is very good in one technique may not be as good in the other technique. So even though the skier who won the first day's race starts first, the skiers behind may be faster in the second technique, and so will catch up to the winner, resulting in a neck-and-neck race to the finish line.

Skiathlon Competitions

Skiathlon competitions consist of a classical-style race that begins with a mass start (chevron), followed by the changing of skis in an exchange/pit zone in the stadium, and then continues with a second race in the free technique style. There is no break between the two techniques and the total race time includes time in the exchange/pit zone to change skis, poles, and maybe boots. The winner of this type of competition is the skier who crosses the finish line first after completing the classical race, going through the exchange/pit zone, and completing the free technique race. The skis to be used in the second race must be left in the racer's "pit" before the start of the competition.

The location and design of exchange zones can be challenging for stadium layout and may involve exchange pits in a single line through the stadium or two lines of exchange pits (left and right). (See **Section 9 – [Stadium Layouts](#)**)

This competition is very exciting to watch, since it is a mass start, and so the leader at any point in the race is easily identifiable; the winner is the first one across the finish line. However, it is a competition that requires a large stadium to handle: a mass start; an exchange/pit zone for possibly a hundred or so racers; and a finish area that must accommodate a group of skiers racing to the finish line. An additional consideration for the course, is that it must either be very wide to allow both classical tracks and a skating lane to be prepared, or there must be two courses - one for each technique.

Individual Sprint Competitions

Sprint competitions take two forms: Elimination Sprints and King's Court. Elimination Sprints consist of quarter-final, semi-final and final heats after a qualification round. Skiers are eliminated from Quarter- and Semi-final rounds. In 'Kings Court' sprints there are still three rounds of heats after qualification, but skiers are promoted or demoted from their start positions and ski all three rounds rather than be

eliminated. Kings Court is often used in younger categories so that everyone gets to ski three times in a competition that may appear less competitive.

Qualification Round

This round is run to determine the rank, by time, of each skier for the sprint heats. It is run with interval starts and is timed to one one-thousandth of a second (**ICR-CCR Rule 352.1.3**)*; with the results shown to hundredths of a second. Therefore, the timing must be done using an electronic system.

The course will be the one that will be used for the sprint heats. Although passing is allowed, as it is in other individual races, it is preferable to use start intervals that will minimize passing.

The start intervals may be 10, 15, 20, or 30 seconds, but are normally 15 seconds. The start order of this round can be determined by draw, or by points, with the best skiers starting first and being followed by the slower ones. This will reduce the chance of overtaking.

Sprint Elimination Heats

After the qualifying round has been run, there should be a collection of the bibs which will be re-issued for the sprint heats with the numbers reflecting each person's ranking in the qualifying round (i.e. the 1st-place person would receive bib #1, second place would receive bib #2, etc.). With a number of categories, the following bib assignment is suggested (where the top 30 skiers move on to the heats): the men could be assigned bib numbers 1 – 30 with the women being assigned numbers 31 - 60. This method enables everyone to tell the competitors' rankings within a category from the qualification round; making it easy to determine who has the first and subsequent choices of start lanes in the quarter final (the lowest number or fastest qualifier gets first choice, etc.). However, for the second and final rounds, the results and new start lists would have to indicate the new bib assignments. This practice also lets the spectators know the rankings of everyone from the qualifying round, so they can keep track of how racers are doing in each of the heats and rounds. If possible, the athletes should also wear stick-on bib numbers on the outside of the leg on the photo-finish side of the body; helping to identify racers crossing the finish line in photo-finish or video images.

Following the qualification round a specific number of competitors are eligible to continue based on the selected format for the elimination heats. While a number of different elimination heat formats are possible, there are two formats that are most commonly used:

- Five quarter-final heats of six racers each with the top 12 racers advancing to two semi-final heats of six racers each. Those 12 will ultimately advance to either an "A Final" or a "B Final" of six racers each.
- Four quarter-final heats of six racers each with the top eight racers advancing to two semi-final heats of four racers each. Those eight racers ultimately advance to either an "A Final" or a "B Final" of four racers each.

The International Ski Competition Rule Book (**ICR-CCR Section 325**) provides detailed information on the operation of Individual Sprint races.

The start of each sprint heat should begin approximately three to five minutes following the start of the last one depending on the course (its length and the time required to get around it), and the site where it

is held. It is acceptable for a heat to be started before the previous one has come to the finish line. However, it is important that the start not coincide with a finish, as there is often too much noise at the finish for starting competitors to concentrate on starting and to hear the directions of the Starter.

During Semi-finals and A/B Finals, it may be necessary to provide an additional delay so that all racers obtain a reasonable break between the completion of one heat and the start of their next heat – typically 10 minutes minimum.

If there are both a mens' and a ladies' competition at the same site, the starting order should be:

Qualification women	– Qualification men
Quarter-final women	– Quarter-final men
Semi-final women	– Semi-final men
B-final women	– A-final women
B-final men	– A-final men

The sprint-race format will produce a great deal of excitement for both officials and spectators alike. It is a format through which spectators can keep track of racers and their positions fairly easily, creating excitement when the racers approach the finish line. However, to ensure a fair finish, a number of aspects must be done correctly and well by the finish officials:

As each sprint heat is run and the results determined, they should be posted immediately on a results board. To be most efficient, the results from each sprint heat are brought from the finish line to the Chief of Results right away, who should verify that these are as correct as possible. A copy is then taken to the results board for posting; allowing competitors and spectators to keep up to date on the action. The results should be in large enough print to allow reading from a distance.

As for the final results, those competitors who do not make the cut-off to race in the sprint rounds are given the places that they earned in the qualification round. From the first round of the sprint heats, the 18 skiers who do not advance to the next round are ranked in positions 13 to 30.

Role of the Jury in Individual Sprints

The Jury is composed under **CCR Rule 303.1.6.1*** (for Canadian Championships) and **CCR Rule 303.1.6.2*** (Nordiq Canada-sanctioned events). Due to the timeline pressure of running successive heats, it is **NOT** possible to allow protests during the heats. Protests will only be accepted after the finals (as is the case in normal competitions). This implies that, as in all sporting events, trained officials (referees) make the difficult calls to the best of their ability and within the physical restrictions of the venue. So, the TD and the Jury will call it the way they see it. We must accept that there will be differences of opinion on judgment situations but that is part of sport and that is why officials' training is extremely important for some of the key positions.

During the sprint rounds, it is recommended that the members of the Jury, other than the TD, be positioned on the course in places where infractions might occur. The jury can and should be extended with additional members with appropriate experience so the whole course can be observed. In particular, the main infractions that are likely to occur are obstructions due to the tightness of the race, the shortness of the course, and the need to pass competitors during a heat to have a chance of moving on to the next heat round.

In dealing with Sprint Heats it is recognized that obstruction and interference may occur - is not always intentional. Experienced officials are given jury-decision guidelines to assess whether infractions are major or minor and if there is an advantage gained. In the event the infraction is major and there is an advantage gained, the offender will be placed last in their heat and will not progress. Otherwise written or verbal reprimands may apply.

Kings Court Sprint Heats

In Kings Court sprints, all entrants can ski all sprint rounds. If the course width can accommodate six skiers, the top six qualifiers are put in the same heat and the next six qualifiers in another, and so on throughout the field. The fastest heat should be run last. With six skiers per heat, the top two are promoted to a faster heat and the last two demoted to a slower heat. Those in positions three and four stay at the same level. In this format all heats in a round are skied before the next round is started. If the course is not wide enough for six skiers, this format works well with four skiers per heat. In this event, the top two skiers are promoted and the bottom two are demoted.

Team Competitions

Distance Relays

A distance-relay race consists of teams of three or four skiers, with each skier of a team racing a prescribed course (this course is usually the same for all competitors), one after each other, until all team members have finished. Each skier may be required to use the same technique, or the race may have mixed techniques. All skiers in the first leg start at the same time (i.e. a mass start – see Section 4-1 [Mass Starts](#)). After each skier completes his/her course, he/she tags off by touching the body of the next teammate within an Exchange Zone. The first team to have all skiers complete the course wins. The start of these races is exciting, and because of the varying skill levels of the team members, the results are often unpredictable, providing high spectator interest.

For Para Nordic and roller-ski competitions, the competitors do not tag in an exchange zone. The incoming skier crosses an 'exchange' line in a lane adjacent to the one in which the outgoing skier is positioned. When the incoming skier crosses the exchange line, the outgoing skier may start. The exchange line for the incoming skier is slightly ahead of the start line for the outgoing skier. In this way the outgoing skier can see when the 'exchange' line is crossed.

Team Sprint Competitions

These are competitions in which teams of two people each sprint against other teams, with the best five from each of the two semi-final heats moving on to the finals. The first members of each team start together and race the course. They complete the first leg of the race by tagging their partners in the exchange zone, sending that second member of the team to ski the course completely. The second then tags the first in the exchange zone and the process is continued until each member of a team has skied the course three times. (Note that some races may have only two legs per racer.) For each of the two semi-final heats, the top five teams move on to the finals.

ICR-CCR Rule 326.4.3 states that “The number of teams in one semi-final heat or in the final should not exceed 15.” The starting order is determined through a ranking of each team. In FIS competitions, the

team with the lowest (best) combined FIS-sprint points starts as the number 1 team; the team with the second lowest (second best) FIS-sprint points start as number 2 team, and so on. In the event that two teams have equal points, the team with the lowest point-holder starts ahead of the other. If the lowest points are equal, the starting order will be drawn by lot. Changes to team composition must be declared at least three hours before the Team Captains' Meeting. Any team making a change after that time will start at the back of the starting order at the end of the field. If more than one team is placed at the back, then their start order (at the back) will be the same as their original starting order. The original start positions will be left empty.

A chevron mass start is used, with three or five parallel tracks 1.5 m apart, that are straight for approximately 10 meters past the first starting position. Any team that is lapped by another team must abandon the race but will be ranked in the results.

ICR Section 326 provides detailed information on the determination and posting of Team Sprint results.

The course will be like the course for an individual sprint, about 8-10 meters wide for Free Technique, and at least nine meters wide on any uphill to accommodate the extra space require to skate uphill. Sections of the course must be designed straight, wide, and long enough to make overtaking possible. The exchange zone must be at least 15 meters wide and 45 meters long and be located after the finish line. It should be well situated and prepared so that the speed of the competitors is slow enough to permit a clean exchange. There must be a minimum of four corridors to the finish.

Juries can reduce the number of legs for each skier to two if there is a tight schedule with multiple categories racing.

Popular Cross Country Competitions (Loppets)

Popular cross country competitions are organized for the enjoyment of all participating competitors. Because these competitions involve competitors with a wide range of experience and ability, good sportsmanship and courtesy toward other competitors is essential. This type of competition is usually held over a long distance (generally ~30 km up to ~90 km in some competitions). It is usually held over a large loop of ski trails, where competitors leave from a start area using the mass start method, ski the course, and then finally return to the finish area in the same location as the start. However, in some cases, popular competitions are held on a course that starts in one location and ends in another many kilometers from the start. For world-class competitors, these competitions may take from about 2.5 hours to over 6 hours to complete; for competitors of lesser ability, it may take almost a day to complete. There are usually a couple of set tracks around the whole course to accommodate any classical technique competitors, and there will be a number of feed stations along the course to provide drinks and sometimes something to eat for the competitors (the rules state that there should be a feeding station approximately every 10 km, but in easy terrain, the distance may be increased; and in difficult terrain, the distance may be shortened). Where the competition is longer than 50 km, different types of drink and other appropriate nourishment should be provided.

Since there are often skiers with different abilities, the course layout should accommodate all levels of competitors from recreational racers to elite athletes. Normally, there will be a timing system and each competitor will receive a report of the elapsed time that it took him/her to complete the course.

SECTION 5: Course Design and Homologation

Course design and homologation are included in this Manual to outline for event organizers the philosophy and attitude our organization is trying to achieve in setting a competition-site standard for the sport of cross country skiing. Homologation aids in this process by evaluating a given trail against a standard set by Nordiq Canada for that level of competition. There is no attempt to provide a complete manual on either of these subjects as the FIS and Nordiq Canada have established homologation standards along with a system to evaluate sites. Detailed information on both subjects should be sought through Nordiq Canada or through your divisional Cross Country office.

Homologation (from the verb homologate, meaning to approve or confirm officially) is the certification of a product or specification to indicate that it meets certain standard and criteria. So, in cross country skiing, a ski course is homologated to ensure that it meets the course design standards that the governing body has set.

Course Design

The design of cross country ski trails for competition and recreation purposes has become considerably more complex during the last many years. This change has been brought about, in part, by improvements in grooming and track setting equipment now available. The response to improved courses has been the development of improved ski equipment to take advantage of these trails and to allow for more glide, speed, and excitement in cross country skiing.

An added change to cross country skiing is that the sport has developed into three broad but distinct types of skiing.

Back-Country Touring

Skiing is done on non-groomed hiking trails, cut lines, forestry roads etc., where the skier is going for an outdoor adventure tour or to travel to a winter cabin or campsite. This type of skiing almost always uses the classical technique.

Recreational Track Skiing

Skiing is done on designed and groomed trails in a given area often associated with a park, a club, or a lodge. Skiers use light-touring or competition equipment and either the classical or free technique style for exercise, training or just plain fun on skis.

Competition Skiing

Skiing is done on designed and groomed trails at an appropriate site, which may also be a recreational site. Skiers compete to see who is fastest over a given distance using a specified technique. There are two types of competition skiing: the Olympic style is a high-performance competition in which skiers are started using a variety of start techniques and compete one on one to see who is fastest. The popular cross country ski competition (a loppet, or citizen-style competition) involves a mass start. In loppets, competitors participate to see how well they race against their peers over, what is frequently, a long distance.

Courses designed for Olympic-style competitions lead the way in the development of new approaches to skiing and to course design philosophy. Today, competition sites are being designed to increase the exposure of the competitors during the race to spectators, media and officials. Spectators now have better access to the racecourse where they can cheer for competitors and be much more in touch with the progress of the race. Racers are encouraged by this support, and the increased exposure is adding to the interest and enjoyment experienced by fans of cross country ski racing. To affect this change, racecourses are now being designed with several short looping courses of varying lengths and difficulty that enter and leave the stadium a number of times, rather than a few courses of longer lengths where skiers are seldom seen in the stadium area. The stadium area must be designed with a "thru" track as well as the traditional start /finish area to allow the skiers to ski through the stadium as part of the race. The stadium area and on-course areas must have spectator viewing sites to allow viewing of the races.

The course, along with the stadium trails, is the "field of play" for a cross country ski race and is of prime consideration in the planning of any cross country event. The course should be designed to run through hilly terrain which may be covered with trees and bush to provide protection for the trails from snow loss by wind and sunshine; although courses that are laid out in a treeless valley allow spectators to see the complete race from the stadium area. The course must be laid out so as to be fun to ski; yet must be a technical, tactical and physical test of the competitors' qualifications. The degree of difficulty should be in accordance with the level of competition. The course should be laid out as naturally as possible, with undulating sections and climbs to avoid monotony.

Rhythm should be broken as little as possible by sharp changes in direction or sudden, steep climbs. The downhill sections should be laid out so that they can be negotiated without danger, even on a fast or icy track. The course must be prepared to such a width that the competitors can ski safely and pass each other with no obstructions.

The degree of difficulty for racecourses is laid down for the various standard race distances and age classes by Nordiq Canada's or FIS' "homologation standards". At present only a few courses in Canada are homologated; however, in the future, courses may have to be homologated in order to be eligible to hold major competitions. Master skiers and young people competing on courses designed and built to full Nordiq Canada/FIS senior-level standards are finding the physical demand of some courses too difficult. Technical specifications of courses for younger age classes are currently provided in **Nordiq Canada's Rule Book (ICR-CCR Section 311.2.5)**

Loppet-type competition courses are well-established in Canada and vary considerably in the degree of difficulty and the length of course used. Generally, the courses are located in large parks or link a series of trails between two towns or centres to provide a touring-type experience for the competition. The courses are not as technically demanding as are Olympic-type courses, but they do frequently have a high-endurance component in their design. Loppets are usually mass-start events and normally have a large number of entrants. Therefore, wide start areas with long, open areas immediately after the start area are required to allow competitors to vie for position before skiing onto the actual course. Some courses have a number of tracks for several kilometres to allow further sorting of the competitors.

Recreational track-skiing venues are often Olympic-style competition sites as well. The combination of two types of skiing to utilize such facilities makes good economic sense. However, problems can arise if a competition site is designed only for high-level competition. The demands of the long uphill and the speed of the steep downhill sections are often too difficult for recreational skiers. This creates a need for course designers to include less difficult trails for the recreational skier and younger age class competitor

in their design. The design changes required to increase the utilization of competition sites for recreation purposes need not be difficult. Sometimes a course can be rendered appropriate for all competitors by simply offering a cut-off from a difficult section. Course designers must be prepared to be creative and flexible.

Homologation

Historical Perspective

Homologation has been part of ski competitions for many years. In the beginning, the process of “certifying a standard” was born out of a need for safety. That consideration led to the determination of “difficulty ratings” which, in turn, led to course-design criteria. Skiers in other ski disciplines were travelling at much higher speeds, and as such, were exposed to high risk. On the other hand, cross country skiing was breaking trail through woodlands with each new snowfall, making sure speeds were never too high. As stated earlier, all this has changed in the last few years and cross country skiers now ski on hard-packed tracks at high speeds and on downhill sections where they assume equally-high risks as their counterparts in other ski disciplines. Homologation has become a needed process for cross country skiing. It will ensure a continued growth in the sport by guaranteeing a continual challenge to all skiers against which they can test their skills in a safe yet exciting environment.

Philosophy of Homologation

Homologation is a “**system of evaluation/certification**” that is designed to guide the development and upgrading of cross country racecourses. It is not just a set of numbers but is a process of certification that provides a forum for constructive discussion between organizers, designers and inspectors in the area of course design.

The homologation evaluation process includes the course, the stadium and the infrastructure installations. The resulting certification represents the appropriate-level sport-governing-body “stamp of approval” that the site is physically capable of accommodating the desired level of competition. In addition, homologation helps satisfy the need for course maps that have accurate distances and profiles on them; and that must be published in race invitations and made available to all concerned at the event. In Canada, homologation of a site is done by an appointed and approved Nordiq Canada inspector.

When developing a new competition site, one has an opportunity to design to homologation standards from the beginning. The sequence of events should be that the course designer designs the courses and layouts, then the homologation inspector evaluates it. Often, the pair works together as the course is being designed, so that changes can be made where courses would not meet homologation standards. When new courses are being designed, attention should be given to providing trails that service both the elite and novice racers, i.e. creating multiple-use trails. Once it appears that the design would meet standards, then trails/courses can be cut on the land and the stadium prepared so that the two entities fit together. Stadiums must fit the trails, i.e. trails should enter and exit the stadium so as to minimize both crossovers and athlete choices of which trails to choose during competition events. Too often, the stadium is designed first and then the trail system is fitted to it; doing this can lead to problems of crossovers, especially when multi-loop trails are to be used, as is currently the trend in modern race formats.

Existing sites that are evaluated for homologation certification will usually undergo some design changes to improve their standards.

Homologation Policy for Nordiq Canada

Any and all FIS-sanctioned races require that their course be homologated. This applies to:

- Canadian Championships
- NORAM events
- Eastern and Western Canadian Championships
- Canada Winter Games

The standards against which a course is homologated are set out in the **Nordiq Canada Rules (FIS ICR – CCR (Canadian Competition Rules))** and the **FIS Cross-Country Homologation Manual**. More specifically, courses must be designed to accommodate maximum distances for certain age groups (i.e. in Canada, the maximum competition distance for an Under 16 girl is 10 km, while for a Senior man it is 50 km). The rules also lay out the degree of difficulty that a course must not exceed for each age group. This is done by setting out maximums in Height Difference (the maximum allowable difference in height between the lowest and highest points of a competition course); the Maximum Climb (the maximum allowable height of a single climb); and the maximum Total Climb of the course (the maximum of the total of all climbs on the course). The homologation standards also describe uphill sections; defining major uphills, short uphills, and steep uphills.

The regulations set out the norms for course profiles; state the definitions and limits for major uphills, short uphills, and steep uphills; and provide guidelines for uphill design, descriptions of undulating terrain, and guidelines for planning a competition distance. Quite frankly, the specifications are quite interesting, and, after reading them, one acquires a respect for those who set out the standards for a cross country ski course that respects the aims of safety, challenge, and competitiveness.

From the homologation data, a final course map can be produced that shows the profile of the uphills and downhills along the course and the maximum and total climb; and also sets out the actual distance of the course - all with a high accuracy rating.

Organizers who wish to design a course that could be used for various levels of competition should contact the Nordiq Canada office to arrange a visit and meeting with a homologation inspector before actually carving any trails and stadium out of an area. Producing trails without the help of a homologation inspector/course designer may result in a set of trails that will only support local, low-level races and not high-level races.

Para Nordic Considerations

In general, racers in the Standing and Visually-Impaired categories can ski on courses that are very close to regular FIS courses. However, the following points should be considered:

- avoiding fast downhills with curves and corners that can be difficult and unsafe for visually-impaired skiers;
- using shorter loops such that visually-impaired skier can become familiar with the course more easily;

- reducing the longest climbs to medium-length climbs; and
- keeping the range for the total climb generally in the low range of the FIS standards.

Courses for the Sit-Ski category cannot use normal FIS courses due to the fact that sit-skiers have no use of their lower body and pull themselves forward with poles from a sitting position (on their sledge).

The following points should therefore be considered when designing courses for the Sit-Ski category:

- Uphills should generally not be steeper than a 10 – 12 % gradient, and not longer than 200 m in length.
- Downhills should have straight runouts preferably with a slight uphill to break the speed. The hills should not be steeper than a 12 – 14 % gradient.
- Corners and turns should be placed where the speed is slow.
- Corners on a flat part of the course should optimally not be less than a 90° angle (with a larger angle being required for downhill corners). This applies in the stadium as well, for example, for lapping.
- The radius of turns on level terrain should also be considered. To stay in tracks at any but the most moderate speed a sit skier needs a radius of 15 metres or more.
- It is also essential the track is set on level or favourably banked terrain.

Homologation specifications for para-nordic-course layout and design can be found in the World Para Nordic Skiing Homologation Guide.

(https://www.paralympic.org/sites/default/files/document/171116152536727_World+Para+Nordic+Skiing+Homologation+Guide2017_0.pdf)

SECTION 6: COURSE PREPARATION & TRACK SETTING

Why Groom

Grooming is the working or reworking of snow using special vehicles and attached equipment in order to provide consistent skiing conditions. The objective is to create a smooth and level trail surface that is firm enough to support the skiers and their poling, and at the same time to have enough loose workable snow to set clean and hard classic tracks and leave firm corduroy for free technique. Grooming requires well-prepared terrain on which to set the course.

Early Stages of Course Preparation

Proper course preparation is a process that starts long before the actual competition. After the course design and homologation process the courses need to be cut and cleared, have stumps and rocks removed, and be graded. Existing courses need to be brushed. Some low-snow ski areas use heavy rollers to smooth out bumps and push down rocks. Any low, wet areas and flowing water need to be ditched and drained. Culverts must be added where water is crossing the trail. All of this phase of course preparation should to be completed during the off-season prior to the first snow.

First Snow

At the first sign of colder weather and 10 cms or more of snow, packing should be initiated. Rolling, packing, or dragging these initial snowfalls will start the leveling of the ski surface. Early packing will also minimize the insulating properties of the snow enabling the ground to freeze. Frozen ground minimizes melting of the snowpack from the base upwards.

Equipment: Ideal vehicles to do this could be wide-tracked snowmobiles, tracked ATVs, or tracked side-by-sides; pulling some sort of roller, compactor, drag, or rubber carpet with combing. A grooming attachment from YTS (Ginzu) or Tidd Tech with the cutting knives raised up can also work.

Snow Making

Some nordic centers have invested in snowmaking infrastructure and are able to make snow as soon as the temperature is below -3°C. Nordic centers in eastern Canada have been able to kick start their season by almost a month with snow making.

There are two variations of snowmaking equipment:

- Fan guns which require pressurized water, high-voltage three-phase power; and have a built-in air compressor. A fan gun usually consists of a series of rings of [nozzles](#) which inject water inwards into the jet of air from the fan. Separate nozzles are fed with a mix of high-pressure water and the [compressed air](#) that produces the nucleation needed for the formulation of snow crystals. The small droplets of water and the tiny ice crystals are then mixed and propelled out by the [fan](#); after which they are further cooled through evaporation as they fall to the ground. Fan guns have the ability to launch the water particles high into the air for a long “hang time” and can make large amounts of good-quality snow.
- Air / Water Lances which use a combination of compressed air and high-pressure water, are more economical and do not use electricity. This method requires a large, separate compressor

and a set of two pipes to bring the compressed air and high-pressure water to the various hydrants. Lances can make great snow in colder / drier weather.

Fan guns spread snow over a wide area and are great for stadiums or any multi lane or two track areas. For narrower six-metre-wide tracks, smaller lances can make narrow ridges of snow which if carefully managed by moving them along the trail, can minimize the size of piles which need to be pushed out.

Snow Farming

Summer-season weather permitting, some areas in Canada are able to either make large amounts of snow when snow-making conditions are ideal or save natural snow. The saved snow is piled and covered with reflective, insulating tarps and/or wood chips and left alone until later in the fall. Once the temperatures permit, the snow is uncovered, spread, and groomed.

Early- to Mid-Winter (Pre-event)

Courses

As winter progresses and the site receives more snow, grooming should occur on a regular basis. When the packed snow depth reaches 10 cms or more, depending on the smoothness of the trail surface, bigger grooming equipment and/or cutting knives on the tow-behind grooming attachment can be used. Rougher terrain will require more snow. Wet areas should be addressed with additional snow or a combination of branches and snow to allow water to travel underneath.

With additional snow and regular grooming, the trails will be smoothed out, dips filled in and bumps shaved off. Ditches can be filled, and the ski surface widened. Downhill corners can be banked where necessary. Apart from the daily skier benefit of regular grooming, the snow surface on the courses will become denser, flatter, wider, and smooth. The ground below the ski surface will freeze deeper ensuring less loss of snow from the base upwards. When courses are only the width of a single pass of a larger cat groomer, uniform packing across the width of the trail is difficult. Additional packing will definitely be required by lifting up or removing the tiller, and track-packing the centers and each edge of the ski surfaces. In certain conditions, snowmobile packing can be used to accomplish a similar result.

Stadium

The surface of the stadium should be worked until it is as flat as possible. A slight uphill incline to the finish and out of the start would be preferred over a slight downhill. Classic tracks will go in straighter if the snow surface is flat. Groomers will use varying techniques from as high tech as laser beams to low tech ropes or boot lines to assist with straight classic tracks in the stadium.

Equipment

Most grooming of Nordic areas with extensive trail networks or who host significant competitions will be using larger cat groomers like those made by Kassbohrer (Pisten Bully) or Prinoth (Bombardier). Some characteristics and benefits of Cat groomers follow:

- Tracks with either aluminum or steel (or a combination thereof) grousers for traction, with added ice picks to help with lateral stability of the vehicle. Some parks and golf courses will not

allow ice picks in order to minimize terrain damage. Rubber or summer tracks are also available and are used in some areas during the early low-snow season.

- Front blades used for pushing, leveling and grading; and rear-mounted tillers with urethane combing, resulting in perfect ski surfaces. Ensure the finer Nordic combing is used for cross country events as courser alpine combing is too aggressive for cross country skis. The “depth of cut” or “tiller depth”, as well as “tiller pressure”, are all adjustable by the operator on a Cat groomer. “Tiller box” refers to the space surrounding the tiller which can be varied according to snow conditions.
- Track pans mounted to a bar behind the tiller which can be independently raised and lowered from within the cab. The spacing of track pans can usually be altered to accommodate various course or stadium requirements. Down-pressure of track pans can also be varied according to snow density.
- Blades that can be removed and switched for a front renovator. Front renovators are used for breaking up hard crusts and bringing up fresher snow after freeze-thaw cycles or high-traffic events.

In summary, local experience with the snow and the conditions, paired with the various adjustments and options of the Cat grooming equipment, allows operators to handle most situations.

The Event

When to groom: The timing of grooming will be determined by three factors; the event schedule, the length of time required to do the work, and, the weather.

Event schedule

The courses must be closed to skiing and other traffic for successful and safe grooming. Keep in mind that at high-level events there can be TV camera moves, fueling of remote generators, or calibration of various timing points which all require traffic on the racecourse. Security staff are sometimes present to keep the public off of the courses. Wax techs are usually the first to arrive and the last to leave, so grooming needs to wait until they are done and ideally be finished long before they arrive.

Length of Time Required

Consider the time required to do all of the work and leave sufficient time for the snow to set up or “sinter” prior to the arrival of skiers, coaches, and wax techs. Always leave a margin of error in the length-of-time calculation. The job inevitably takes longer than expected and there is always the possibility of a mechanical problem.

Weather

If you end up with eight available hours of the course being closed and free of traffic and you estimate it will take four hours to do the work, then the last factor is the weather. The overnight forecasted temperature and precipitation will determine when the ideal grooming time will be. Basically, there are three choices;

1. During stable, ***non-precipitation nights***, ideal grooming time is immediately after course closure to let everything firm-up well before the next day.

2. In the case of **snow, rain, or high wind and drifting snow**, grooming may have to be delayed to be finished just prior to the course opening. Course officials may have to rely on the assistance of forerunners prior to the event in the case of continuing snow or drifting snow prior to race start. Last-minute grooming with bigger equipment is not the best option as the resulting ski surface will be soft. Last-minute packing or track setting could be done by smaller implements if necessary.
3. Another weather variable is if you are in a **freeze-thaw cycle** with above-freezing temperatures during the day, transitioning to below-freezing overnight. If the entire stadium and course can be groomed prior to the temperature falling below freezing, then doing so will result in solid, firm tracks. After an extended period above freezing or rain event, the snow in the base layer of the course may be so saturated with water that grooming needs to be postponed until after the transition. If the temperatures stay above freezing, smaller, lighter grooming equipment may need to be used. Try to avoid grooming on either side the transition as the result will be varying snow conditions over the different sections of the course.

Type of event

Free Technique Events

(Refer to: ICR-CCR Rules Section B: 311.3.4*) Free-technique events are the simplest to prepare for as the course usually does not require any tracks. Once the ski surface has been “cleaned up”, the last pass should be a continuous, best-line pass, if possible. Course markers will then be able to use the combing lines for neat v-board placement. The Jury may request a single classic track on one side of longer downhills for distance races and / or for nordic-combined events. Start areas in the stadium have varying requirements for classic tracks, as shown in the table below.

Short summary of Classic-Track requirements in Free-Technique events.

(Refer to ICR-CCR Rules Section C: 321 – 327*)

	Course	Start	Length of Tracks after Start line	Distance between Tracks in Start	Finish	Distance between Tracks in Finish
Interval Start	/	/	/	/	/	/
Mass Start	/	5 or 7	30 to 50 meters	1.2 meters	/	/
Individual Sprint	/	7	15 meters	1.8 meters	/	/
Para Nordic standing - all classes	1 track right side	1 track right side				Per sit ski requirements for different formats

Classical Technique Events

(Refer to: ICR-CCR Rules Section B: 311.3.3*) Classical-technique events are much more complicated and are the true challenge for the groomers. 19 tracks of varying lengths and orientations are possible in stadiums set up for a mass-start classic race. Stadium crews need to be onsite during grooming to provide guidance. They will need to have their layout maps, measuring tapes, ropes, and whatever equipment is being used for lining up tracks. It is a good idea for the grooming crew to meet with the Chief of Stadium to go through the grooming and track-setting plan well before actually doing the work.

Courses can have up to six tracks after the start, and up to four for the balance. Even when setting four tracks, “best line” or “ideal line” can be used on courses that are wider than five meters. On fast downhill, some or all tracks may be removed or scrubbed. On fast downhill corners where a good skier cannot stay in the track, the tracks are always removed. On flat or climbing tight-radius corners where a ski cannot stay in the track, the track is removed, and this area is marked as a “Turning Zone” (Refer to: ICR-CCR Rules Section B: 310.2.2.3). On a course where the number of tracks change, there is always a scrub zone, i.e. after the start going from seven to four tracks, or further along the course going from four to two tracks. Ideally, all of the scrub or turning zones are marked with stakes by the Jury prior to grooming. At lower-level competitions they can be marked on the course map and roughly put in during the grooming period with the understanding that some manual adjustment with rakes or shovels may be necessary prior to the event. Groomer operators need to have a course-grooming plan, either on a map or in their heads, considering all of the above and an “escape route”: i.e. When you set your last set of tracks will the grooming equipment be able to exit the course? Many finish areas don’t have a way out, and event organizers do not want a big Prinoth Bison or a Pisten Bully 400 sitting in the finish area.

Short summary of Classic Track requirements in Classical technique events. (Refer to: ICR-CCR Rules Section C 321 – 327*)

	Course	Distance between Tracks on Course	Start	Length of Tracks after Start line	Distance between Tracks in Start	Finish	Distance between Tracks in Finish
Interval Start	1-2	1.2 meters	1	End of Start Zone	1.2 meters	3-4	1.2 meters
Mass Start	2 - 5	1.2 meters	5 or 7	50 – 100 meters	1.2 meters	3-4	1.2 meters
Individual Sprint	4-5	1.2 meters	7	End of Start Zone	1.8 meters	3-4	1.2 meters

Warm-Up Courses

The Warm-up course needs to be groomed during the same period as the racecourses to have conditions be as similar as possible.

Wax-Test Areas

Wax-test areas are typically provided along or on the course. Wax techs want two parallel and straight tracks with a long, straight runout in order to compare various ski structures and glide wax.

Salting or Fertilizing Snow

Salt (NaCl) or fertilizers such as Urea ($\text{CO}(\text{NH}_2)_2$) can be added to wet snow to firm or freeze up the ski surfaces. Alpine events use hardening techniques regularly. Even though its use in Nordic has been fairly limited in Canada, it is gaining popularity and organizing committees (OC) hosting events in mid to late March may want to consider some form of snow hardening. Depending on regional weather patterns and the type/format of the event, OCs will have to make this decision based on their capacity (financial/human resources etc.). The chemical reaction when salt and snow or ice are combined is “endothermic”, or heat removing, versus “exothermic”, or heat producing. The heat is removed from the surrounding snow-water combination causing it to freeze. This procedure only works when the snow has significant amounts of water in it. Always do a test on a section of non-racecourse or warm-up course to confirm positive results before applying to the racecourse.

If you are new at this, you will be quite amazed at how quickly the reaction occurs and how firm the snow can get. From a skier’s perspective it can be a significant improvement to the race experience, although some will argue that racing in ankle deep slush is just part of racing! Selective spreading is an option where, for example, only uphill areas are treated or only sunny areas etc. The decision to treat needs to happen before skiers are on course otherwise the rough, skied surface will freeze, leaving dangerous conditions. Once treated, skiers need to be kept off the surface for between 15 – 45 minutes for the process to work properly.

As long as your snow is wet and containing the right amount of water, there will almost always be some sort of positive result - the chemistry is the easy part. Where OCs can get caught is in not having enough product, not having tested various spreading methods or not having the personnel or a solid plan to spread the product without causing major race delays. You can have a very positive effect on the ski surface without breaking the bank. Below are samples of various products that have worked quite well. Depending on what part of the country you’re in 40-0-0 fertilizer may be hard to find - it’s also ten times the price of salt.

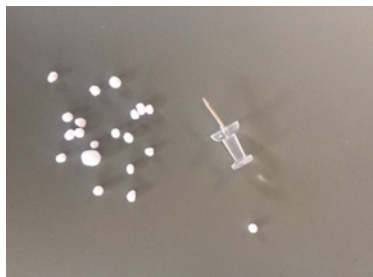

40-0-0 Fertilizer – Clean, spreads easily, works very well but costs around \$45/20kg bag; sometimes hard to find – was heavily used in the 2010 Olympics.



Rock Salt from Canadian tire – Does work but contains quite large grains and looks dirty in the snow. It needs time to sink below the surface – this product can work well when applied the night before and groomed into the snow. Very cheap at about \$4/bag



Food-Grade Pretzel Salt – Comes from a commercial salt supplier to restaurants and bakeries. Works very well and is easy to spread, is very clean with a good grain size. It is more expensive and a bit tricky to find.



Ice Salt from Canadian tire – This is probably the best all-round product, \$5/bag, readily available at Canadian tire, its clean, spreads easily, works very well and lasts several hours. This is what will likely be used at future World Cups.



Bulk Road Salt – This came from the bulk section at Burnco. It's mixed with sand to make a pickle mix. It is a very fine grain almost like table salt, works very quickly (60 sec) but does not have the longevity of the larger grain. It is very cheap at about \$3/25kg. The pink color did not show up on the snow. It might not be a first choice, but it is useable.

Equipment: Salt or fertilizer is spread over the finished ski surface by hand, a back-pack motorized blower “park monkey”, a farm-use fertilizer spreader with 12V electric motors mounted on the rear of a snowmobile, or by larger units mounted on the front blade or rear deck of a cat groomer.

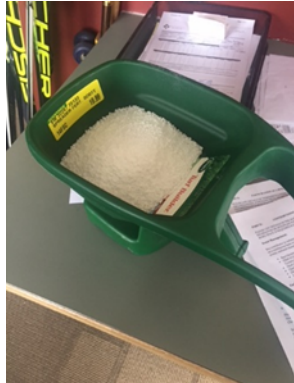

This is another inexpensive simple option that holds 25+ Kg of product. The wheels must turn to distribute the product but don't work that well on snow. Screws may be inserted into the plastic wheels to greatly improve traction. If doing an entire course or several sections, consider having various caches of product to make refilling efficient.



This is a very simple hand spreader with six settings depending on grain size. It does empty out very quickly, so it is useful to have an additional person with a toboggan carrying the product so the spreader can be refilled quickly.

Salting & Fertilizing does not have to be complicated - quite often just spreading by hand on some uphill and corners is all you need, At the Seefeld World Championships 2019, they salted an entire 7.5km-course by hand for the 30 and 50km events, and just a couple hills by hand on other days. The key is simply to be organized, have a plan, test and re-test, communicate to the coaches, and if possible, have designated person or chief in charge of salting.

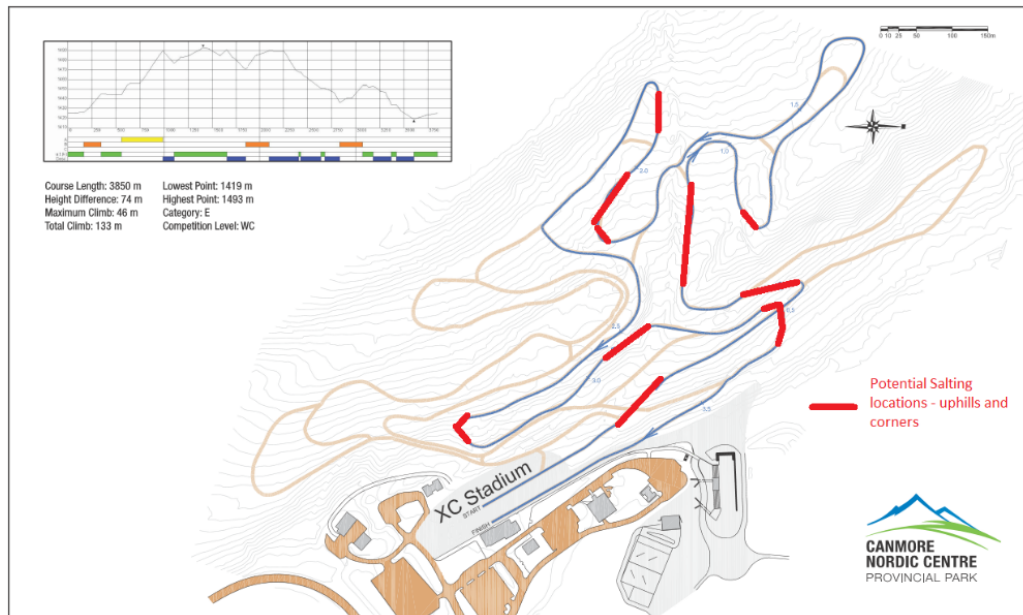

Sample Salting Plan

N.B. Use of these products can result in competitors and coaches carrying a residue of nitrogen-rich chemicals off site. This can be detected at airport security as an explosive constituent. Have the Competition Secretariat prepare disclaimer letters for these people to carry after the event. See [Section 11](#) for more information on the Secretariat and [Appendix 4](#) (near the end) for a sample letter.

Manual or “Touch-Up” Grooming During the Event

Common questions during an event are: Will you regroom before the next category or between qualifiers and heats? Should we rake out the berm on that corner or shovel snow on top of the icy spot on the hill? Most often the answer is no, but occasionally “touch up” grooming can make the skiing better and safer for the participants.

During a snowy day of sprints, the six start lanes may need to be regroomed after the qualifier and prior to the start of the heats. Small amounts of snow in classic tracks are best “skied in”, but significant amounts may be better machine groomed. A snowmobile or tracked ATV with a Ginzu or Tidd Tech should be able to get through the start lanes and even reset the track if necessary. If start gates are used, then this method is not possible and snow may need to be shoveled, raked or blown off, and classic tracks manually skied in. The course outside of the start and finish could be regroomed with lighter equipment. Doing touch up grooming even with a smaller cat, like a Prinoth Husky or PB 100, will only create softer snow.

Occasionally classic tracks may need to be removed partway through an event like skiathlon. Short lengths of track can be removed with a rake, or if the snow is hard a shovel may help. For longer sections, a Ginzu or Tidd Tech with the knives or cutters set to near the bottom of the classic track depth may be used. A double pass or two machines one behind the other may be necessary and the result will likely be softer snow.

Berms which form on the outside of corners or the icy spots left on the inside can be covered up with rakes and/or shovels. However, skiers should expect conditions to deteriorate with multiple laps and try to avoid icy patches if they can. The result is basically cosmetic, as the berm will quickly come back with lapping skiers. Care needs to be taken to avoid skiers. It is best not to drastically change the conditions between laps as skiers should have the expectation that the course condition will change naturally mid-race.

Para Nordic Considerations

Course design aspects are covered previously in Section 5: Course Design and Homologation. However, there are certain essentials in grooming and track setting for Para Nordic skiers. Generally speaking, the standing categories (LW2-9 and B1-3) can handle grooming and track setting the same as able-bodied athletes. However, sit skiers need some special considerations. It is important that the courses set for them are completely level side to side in areas without tracks and/or are banked to the outside on corners; otherwise skiers will slide off the course. The poling lane should be very firm and not off to the side where the outside pole may be in softer snow. The radius of turns should exceed about 15m to enable skiers to stay in tracks. If sit skiers are having difficulty staying in tracks during training, it may be necessary to remove the tracks in the turn.

Salt Testing Data

An example of data collected for testing, Spring 2018:

Salt Testing 2019														
	Date	Product	Time of Application	Air Temp	Overnight Temp	Overnight Humidity	Snow Temp	Application method	Location of test	time of first test	time between test	time of second test	Next day results	Comments
22-Mar	Pink Salt from Burnco	4:45pm	18 C	-4 C	93-100%	0	0	Spreader 2nd setting & Hand	First hill at stairs	6:50pm	2:15		1 a.	1.b
02-Apr	Sifto Ice Salt Canadian tire	2:49pm	11 C	-4 C		0	0	Spreader on #5 setting	Across from stairs on Banff trail	3:05pm	15 min	4:00	2 a.	2 b.
03-Apr	Sifto Ice Salt Canadian tire	9:00pm	5 C	3C		0	0	Hand Spreader on #5 Setting	Across from stairs on Banff trail	12pm next day	26hrs	3pm Next day Air temp was +12	3 a.	
Time of Test														
6:50 PM	Quite good results, noticeable difference. would be a drastic improvement in a race. Still solid ice layer 2" down so didnt really need salting. would not have salted in a race.													
Next Day Results														
1 a.	Slight difference, i think the grain size is too small to last to the next day. The air temp was +12. still not crazy soft. The area was more firm but not by much. done at 12:30pm													
1 b.	Dintd really need to salt as its been cold at night. Almost instant reaction, noticeable change in 90 seconds.													
Thought the pink tint would be noticeable on the snow but it was no problem. because of the small grain size, the mechanical spreader was tricky, used 2nd setting. will continue to play with this.														
2 a.	24hr later the area salted was significantly more firm than non-salted area. I would for sure salt the night before a race. This is good news													
2 b.	Very positive results after 20min. based on price, spreadability, and availability this may be the one. S4/bag at Canadian tire. After 1hr, the ground was very firm, will see how it reacts overnight.													
3 a.	Positive results after 24hr of being in the snow. Not as good as previous results but the purpose of this test was to see if it would work applying it the night before.													
In this case i would be comfortable doing it the night before. the salted area was much more firm than the non salted.														

SECTION 7: COMPETITION CONTROL

The Requirement for Control

ICR-CCR Rule 302.3.6* sets out the following:

The Chief of Control and Competition Security is, together with the Jury, responsible for organizing the suitable placing of controllers to collect all pertinent information and control cards after the competition and to report any incidents to the Jury.

Two controllers are necessary for each post. The number and placing of the controllers are determined without notifying the competitors, coaches or other officials. The controllers at each post record violations and the passing of the competitors. They may use video equipment. After the competition they must inform the Chief of Control and competition security of any violations to the rules and be ready to testify before the Jury.

Chief of Competition Control

Reports to the Chief of Competition and the Jury

Oversees the Controllers

Duties:

- Lap / bib control – to record bib sequence and number of laps to confirm that all competitors have skied the entire course.
- Infraction (video) control – to monitor race progress, record and report any rule infractions.
- Monitor format-specific activities including pursuit starts, relay exchange zones, sprint and mass starts.

Controller Recruitment:

The number of teams of controllers will depend on the type and level of the event, race format, course characteristics, Jury direction. Typically, a minimum of between two and five controller teams plus support personnel are required.

When selecting controllers, the following attributes should be considered:

- Experienced official, knowledgeable of the rules.
- Experienced skier, familiar with ski racing, race dynamics, proper ski technique.
- Multi-tasker with strong attention to detail.
- Good technical aptitude and familiarity with technical control equipment (video, radio, data transmission).

Bib Control:

- Use one to two teams of two controllers. Each team includes:
- Sequence recorder

- Caller and lap-count recorder
- Position teams at extremity locations on course past any short cut options where all skiers must pass and where the bibs are readily visible to the control teams (e.g. uphill, straight stretch versus fast downhill, tight corners). On single-loop courses, usually only one station is required. On more complex courses (e.g. multiple-loop courses, long-distance popular races with point-to-point checkpoints), more teams are required.
- Use Nordic Canada Bib Order and Lap Count Forms (See [Appendix 6](#)):
- The Bib Order form is used to record the sequence in which each skier passes a control point. The control team works together with a caller and recorder, especially when a train of skiers is passing.
- The Lap Count form is used to record the number of times each bib has passed the control point. This form is completed from the information collected on the Bib Order form and is updated through the competition during periods when no skiers are passing.
- Lap count can also be recorded electronically by transponder loop and monitored directly by timing and results. This may be enough if short on staff, but manual recording provides important back up and redundancy in the event of transponder / data failures.

Infraction Control (Video):

- Video control has become standard at higher-level competitions (Tier 1 &2), and a default Jury tool for assessing infractions and education. Video control is not always definitive - angle of view and perspective is important and single views do not always provide all the information about an infraction/incident, therefore careful planning is important.
- The use of video requires several teams of two controllers (joint observation and recording), as well as runner(s), to deliver video to the Jury room; and a video-playback operator to receive and prepare video for Jury review.
- Video-control points should be set up in locations with a higher probability of infractions that may impact competition result / fairness such as in technique zones (uphill and turning) for classical technique control, potential obstruction points, i.e. mass start, sprint, exchange zones, pursuit start areas and finish corridors.

Equipment:

- A variety of recording devices may be used from hand-held digital video cameras to cell phones, tablets, and GoPro-type cameras. Typically, these devices would be mounted on a tripod to provide a stable platform and consistent view.
- Other equipment includes backup batteries, replacement memory cards (numbered for identification), warmers (during cold weather handwarmers can be attached to devices to keep batteries warm), covers (plastic bags, modified plastic milk jugs, umbrellas etc.) to protect devices during wet weather or heavy snowfall.
- Clipboards, recording forms, pencils.
- Radios

Procedures:

- Determine camera location:
- Pre-plan based on course and competition characteristics;
- set up for suitable perspective and field of view of activity;
- check/test location during official training or warm up; and
- verify the location and focus with Jury member(s).
- Know the recording device operation:
- Determine camera operation needs: continuous or intermittent, and test functions (on/off, record, pause, stop, review).
- If using digital devices with memory cards practice removal /insertion of cards.
- If using phone/table devices/apps and wireless transmission of video, test/practice video capture, saving, file naming, and transmission procedures.

Infraction Recording:

Use prepared forms (Nordiq Canada Infraction Report - Appendix 6) for manual recording of:

- team/location/event information;
- number of the memory card and the time on the recording;
- infraction category;
- bib number;
- time of infraction; and
- any observations.
- Best Practices:
- Include a list of most common infractions with ICR-CCR references and decision-tree guidance on controller recording form.
- Use a controller log to track a list and chronology of infractions reported and memory card numbers.
- Communication of infractions to the Jury:
- notify the Chief of Competition Control by radio of the infraction. Include:
- Control team identification / location
- Bib number(s) involved
- Nature of infraction
- Method and timing of transmission of video evidence to Jury
- transmit the video evidence to the Jury by:
- physical delivery of tape/memory card from conventional video cameras - requires backup media (memory cards) and a runner to deliver the evidence (memory card and controller form).
- wireless transmission – increasingly possible with portable hand-held devices (phone, tablet) with messaging apps but requires wireless network (Wi-Fi) / cellular coverage.
- play back the evidence at the Jury room:
- prepare and display the video to the Jury, normally on a laptop connected to a larger screen;

- find the infraction (as per details/description on the controller form); and
- play back the clip at normal speed, slow motion, and stop action/frame by frame.
- file the evidence:
- transfer video clips to a computer using a descriptive file name for cataloguing and save the file.

SECTION 8: COURSE OFFICIALS

Chief of Course

Reports to the Chief of Competition

Oversees:

- Chief of Mechanical Grooming
- Chief of Manual Grooming
- Chief of Course Marshals
- Chief of Forerunners
- Chief of Temperature Stations

The Chief of Course is responsible for preparing, maintaining, and controlling the racecourse to satisfy the needs of the competitor and to meet the technical and safety standards applicable to the competition. This person also works closely with the Chief of Stadium regarding the grooming and track setting within the stadium itself.

Duties:

Pre-race:

- recommend appropriate courses for the competition;
- design the trail layout;
- verify the course length and homologation standards;
- produce the course map(s) and profiles;
- plan on-course first aid and the evacuation of the injured;
- prepare the course for official training and race days;
- organize course markings and signage;
- prepare the warm-up trail and wax-testing area;
- provide training for Course officials;
- organize grooming and track setting, both on the courses and in the stadium;
- attend Team Captains' meetings and provide course briefings; and
- ski the course with the TD, if possible, and forward the TD's concerns for adjustments to the appropriate member of the Course crew.

During Race:

- supervise all course personnel;
- maintain course security through the Chief of Competition Security;
- dispatch forerunners and course closers; and
- maintain radio / verbal communication with TD, Chief of Competition, and Course Preparation officials.

Post-race:

- ensure that the course sweep is done;
- arrange for the dismantling of equipment its transportation to storage; and

- arrange on-going course preparation during multi-day events.

Equipment:

- radios, start list, course maps

Procedure:

The Chief of Course has one of the most demanding positions on the Competition Committee. Technical knowledge and experience in the tasks of designing, preparing, and track- setting the racecourse must be applied. Fortunately, there are few situations where one must start from scratch and certainly in such cases the Chief of Course, with the aid of the Chief of Competition, would solicit outside opinions and assistance as needed. Regardless of the state of preparedness of a site, the finishing touches and co-ordination of final preparations can be very time consuming. The racecourse is only one area of responsibility which the Chief of Course must oversee. The general list of duties in the job description gives some indication as to why this position often requires a number of Assistant Chiefs.

The Chief of Course must supply a course map and profile for each course that will be used in the event to the Competition Secretary for distribution. This map should contain the information as illustrated in [Appendix 7](#). The use of aerial photos, and/or survey and topographical maps can be employed in this process, or it can be surveyed on the ground. It is advisable for the survey to be professionally done.

An important responsibility of the Chief of Course is instructing and training course officials for their respective duties. This training can usually be coordinated with the Nordiq Canada officials training program, arranged by the Volunteer Coordinator.

It is very important that the Manual Preparation Group understands its importance and be taught to groom the course so that safe and stable conditions will result. The individual duties of these officials are listed separately in this chapter. The Chief of Course should know all of these responsibilities thoroughly and understand their purpose and relative importance.

The placing of signs, flags, and barricades used to control the competitors' path during the race is a task which must be well thought out. Because officials are not allowed to give trail directions to anyone, large signs or barriers must provide the skier with a clearly marked path to follow, thus eliminating verbal misunderstanding. Wherever the trail splits, advanced warning should be given prior to the split, again at the actual split, and then confirmed after the split. (See page 61 below).

In a competition with multiple categories using different courses, it is very desirable, if not mandatory, that the only course open is the one in use. Signage is really for training days. Movable barriers such as V-boards or ropes can be used and moved according to a pre-established schedule. The schedule can be developed based on the start list, distance of the location from the start, and the estimated speed of the slowest skier in the category. Scheduling is best achieved with a computer model; samples of which are shown in Appendix 3.

The Chief of Course should try to obtain feedback about the course throughout the preparation, training and race periods. Coaches and the racers themselves are excellent sources for feedback. As racers finish, where possible, the Chief of Course should ask a few of them if they had any problems concerning the trails or tracks while they were racing. Any comments should be carefully noted and either immediately fixed or fixed in time for the next race.

Observing and controlling the activities of skiers, coaches and spectators, both on and adjacent to the racecourse, represents the bulk of the Chief's responsibilities while the race is in progress. In addition, the Chief of Course should obtain feedback on the course and its condition by talking with competitors who have finished the race, and by talking with coaches. This feedback is generally very detailed, of high value, and constructive; and will identify areas/locations and grooming techniques that have been both very successful and not well done. Those parts identified as not well done can be checked and improvements can then be made to future track setting and grooming.

Chief of Mechanical Grooming

Reports to the Chief of Course

Oversees Machine Operators

The Chief of Mechanical Grooming is responsible for the mechanical grooming and track setting of the racecourse and stadium area.

Duties:

- Pack the snow on the trail system to be used for the event on an on-going basis throughout the season;
- groom the racecourses so as to achieve a smooth, correctly-shaped surface; and
- track set as required by the rules and regulations to the satisfaction of the Chief of Course, Chief of Competition, and the TD.
- Equipment:
- snowmobiles and/or snow-track vehicles with matching snow-grooming and track-setting equipment.

NOTE: Sites which have snowmaking equipment and/or are involved with major amounts of snow transportation usually have a special events crew which manages mechanical grooming and track setting. This crew is trained in mechanical track setting and is supervised by the site management.

Machine Operators

Reports to the Chief of Mechanical Grooming

Machine operators are responsible for the operation of the grooming equipment required to produce a high-quality racecourse regardless of temperature and snow conditions.

Duties:

- Groom and track set as required by the event schedule. Most mechanical grooming is done between 4:00 pm and 6:00 am. [Section 6](#) is an excellent reference for this function.

Chief of Manual Grooming

Reports to the Chief of Course

Oversees:

- Manual Groomers
- Course Markers and Fencers

The Chief of Manual Grooming is responsible for supervising the touch-up of the groomed surface and tracks after the mechanical track setting has been done, and for maintaining the course in a safe condition during the race. Touch-ups should include ensuring that where trails meet, tracks join with each other so that the transition from one trail to another is flawless.

Duties:

- inspect the course after grooming and track setting to determine areas needing touch-up;
- supervise manual groomers to maintain the track in a safe condition in varying weather conditions during the race;
- supervise the placement of fences, barricades and flagging for identifying and securing the course; and
- supervise changes requested by the TD or Jury.

Equipment:

- Skis or snowmobile, course maps

Manual Groomers

Reports to the Chief of Manual Grooming

Manual Groomers are responsible for finishing the course after grooming and track-setting activities have been completed and modifying the course, if required, after the TD inspection is completed.

Equipment:

- shovels, rakes, skis and/or snow machine, snow-machine sled

Procedure:

During the process of mechanical grooming and track setting, ruts and clumps of snow may be left in the track and must be raked and packed smooth. Areas of concern are:

- at tight turns where machines have difficulty turning or where the track setter has been lifted and tracks scrubbed. The change from tracks to no tracks can be too abrupt and create a potential hazard for the skier.
- on a corner or downhill where the tracks may have started too early or have been left in too long and must be raked out to reduce danger. Sharp corners require banking by hand before the event if they are not naturally banked.
- at intersections where one trail was track set after the other and the tracks of the first trail may not join with the final setting – the join must be made manually. One way to manually make the join seamless is simply to put one's boots in the tracks and chisel the joining track by shuffling one's feet to the track ahead. A second way is to use a small sand/beach shovel or garden trowel (a narrow digging tool) and dig out the track.

During an event, if snow conditions are soft and snow cover is minimal, the Manual Grooming Crew must watch potential problem areas and ensure an adequate snow cover is maintained.

Manual groomers finish the job and make mechanical grooming look great!

Workers should be familiar with the methods and rationale of good trail grooming and track setting (see [Section 6](#)), so that their efforts will not detract from the ski-ability of the course. Also remember that, once a competition begins, a course should not be groomed between racers, unless not doing so would make the situation dangerous. Competitors know how a course might change during a race and carrying out grooming that an official might believe will make the course better might, in fact, make it slower. In general, leave the course alone once the grooming has taken place.

Course Markers and Fencers Reports to the Chief of Manual Grooming

Course Markers and Fencers are responsible for the placement of fencing and barricades to secure the course and eliminate places where skiers might go off course. In addition, they position the appropriate course signage and distance markers around the course.

Equipment:

- Pop-up fencing, V-boards, distance signs, direction signs, colour flagging, wide plastic tape, skis and carrying bag, snowmobile and sled, course map(s), start list, course-change schedule and radio.

Procedures:

Course Markers are usually some of the first officials to go on course in the morning on official training and race days. Their job is to set up fences and barricades to secure the course, and to eliminate places where skiers may go off course. They should put signs at any intersections in accordance with guidelines outlined in Section 6 and with CCC rules, and post course length and distance signs showing distance skied. Deployment of signage, fencing and V-boards should be done in the days before the race. Park it off the course to allow for grooming!

As a course-marking official, it is important to always look at the signs, markers, and barriers as if you were a novice racer who has never skied the track before. The markings should be very clear and easily read from a reasonable distance. Signage must at least use characters (i.e. numerals), not just colours, to accommodate colour-blind skiers.

Two course markers should be at each location scheduled for a change to mark off skiers on the start list as they pass. Once the category prior to the course change has passed, the barrier(s) may be changed. Course markers need to be informed of non-starters and late starters to perform their job correctly.

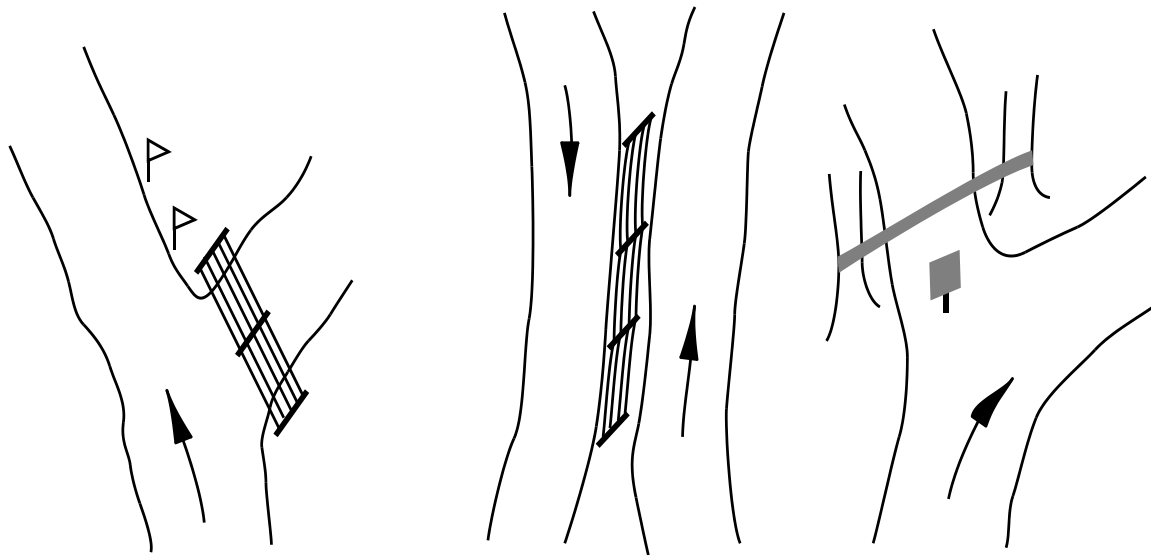

Intersection Fence

Course Divider

Wide Ribbon

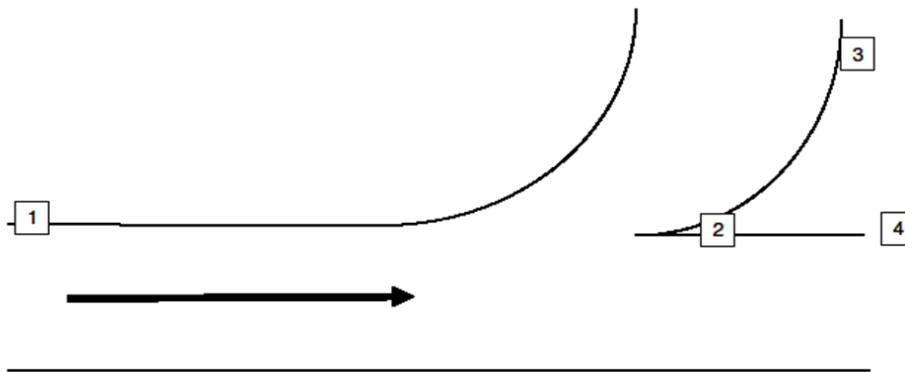

1. Before Intersection	2. At Intersection	3. After Intersection	4. After Intersection
<div style="display: flex; flex-direction: column; align-items: center;"> <div style="background-color: yellow; padding: 2px; margin-bottom: 2px;">3.3k</div> <div style="margin-bottom: 2px;">←</div> <div style="background-color: orange; padding: 2px; margin-bottom: 2px;">3.75k</div> <div style="margin-bottom: 2px;">←</div> <div style="background-color: blue; padding: 2px; margin-bottom: 2px;">5k</div> <div style="margin-bottom: 2px;">↑</div> </div>	<div style="display: flex; flex-direction: column; align-items: center;"> <div style="background-color: yellow; padding: 2px; margin-bottom: 2px;">3.3k</div> <div style="margin-bottom: 2px;">←</div> <div style="background-color: orange; padding: 2px; margin-bottom: 2px;">3.75k</div> <div style="margin-bottom: 2px;">←</div> <div style="background-color: blue; padding: 2px; margin-bottom: 2px;">5k</div> <div style="margin-bottom: 2px;">↑</div> </div>	<div style="display: flex; flex-direction: column; align-items: center;"> <div style="background-color: yellow; padding: 2px; margin-bottom: 2px;">3.3k</div> <div style="margin-bottom: 2px;">↑</div> <div style="background-color: orange; padding: 2px; margin-bottom: 2px;">3.75k</div> <div style="margin-bottom: 2px;">↑</div> </div>	<div style="display: flex; flex-direction: column; align-items: center;"> <div style="background-color: blue; padding: 2px; margin-bottom: 2px;">5k</div> <div style="margin-bottom: 2px;">↑</div> </div>

Chief of Forerunners

Reports to the Chief of Course

Oversees:

- Forerunners
- Course Closers

The Chief of Forerunners manages forerunning and course closing activities. First and foremost, forerunners are used to “ski-in” the course before the first racer starts, ensuring that the tracks are packed and firm for the beginning skiers. If any problems are discovered, forerunners should not fix them, but rather report problems immediately upon returning to the stadium to the Chief of Forerunners who will then arrange for the appropriate personnel to remedy the situation.

Duties:

- ensure that the forerunners know the course and are suitably equipped and waxed for the technique being used for the event;
- start the forerunners at the time given by the Chief of Competition;
- organize trail repair where reported necessary by forerunners; and
- organize the forerunners to provide ceremony for the beginning of the race if so required.

Equipment:

- course map, radio

Forerunners

Report to the Chief of Forerunners

Forerunners are competent skiers who have the responsibility of skiing the tracks just prior to the race so that early skiers are not disadvantaged. It is generally acknowledged that skiers go faster on tracks that have been fairly recently packed (or skied-in), particularly if snow has fallen after the tracks have been set and before the race. It is not necessary that each forerunner ski the complete course; rather, it is strategically better to split the forerunners up so that various parts of the course can be skied at the same time, shortening the time taken to ski in the whole course and return to the stadium area. Of course, the forerunners must ski the course in the proper direction.

Duties:

- ski-in the tracks prior to a classical-technique race;
- form a part of the opening ceremony at the start of major events;
- alert officials on-course that the race has begun and that racers will soon follow;
- review the preparation of the course and report any situations that are inadequate and require improvements to the Chief of Forerunners; and
- ski up and down the stadium tracks to ski in the start and lap lanes, if required.

Procedure:

Traditionally, forerunners are the last stage of track preparation for a classical technique race. This is still true today, although with modern track-setting equipment, fewer forerunners are required for present-day races.

Forerunners ski the course in numbers dictated by the track conditions. Two or three are adequate if the course is in good shape; whereas up to twelve are required if there is a heavy snow fall and the race is important; or if there are a number of different courses being run during the competition, making it too onerous and time-consuming for each forerunner to ski each course. The skiers must leave on the direction of the Chief of Forerunners, working with the Chief of Competition, so that they will not interfere with the actual racers. It is important that these skiers do not herringbone up the hills where racers will ski straight up. They should move off to the side if needed. The width of the skis and boots they use must be of racing standard so as not to break down the walls of the track. When forerunning sit-ski courses, double poling or waxless skis should be used to avoid contamination of the tracks with wax (especially under klister conditions!). When more than one trail system is in use, each trail must be skied in by forerunners. This may result in using more than one group of forerunners.

Equipment:

- Racing skis and boots, special bib

*Course Closers**Reports to the Chief of Forerunners*

Course closers are competent skiers (often forerunners) or snowmobilers who have the responsibility of skiing or touring the course to ensure that the course is clear of all racers.

Procedure:

The Course Closers enter the course on the direction of the Chief of Forerunners, behind the last skier who is starting their last lap in the race. Their main purpose is to check for injured skiers who may be stranded on the trail. Course controllers and first-aid personnel are often used for this purpose. Course Closers must ensure that all sections of the track are checked. They may also be asked to remove temporary barriers and flags etc.; and in such situations, would best travel by snowmobile. It is often faster and simpler to send a good skier around immediately behind the last racer, but at a distance behind that won't interfere or bother the skier.

Equipment:

- radio, course map, racing skis or snowmobile

Chief of Course Marshals*Reports to the Chief of Course for most domestic events*

National Championships may require that a Competition Security Committee be organized. The criteria for the establishment of a Competition Security Committee are the level of competition, number of spectators expected, and the individual site requirements. See [Section 15](#) Competition Security.

Chief of Temperature Stations

Reports to the Chief of Course

Oversees Temperature recorders and Temperature/Weather Board Recorder

The Chief of Temperature Stations is responsible for maintaining the current weather information and forecasts on the weather board ([Section 9](#)) in the starting warmup area and adjacent to the waxing facilities.

Duties:

- supervise and position temperature recorders;
- post all snow and air temperatures on weather boards and weather forms;
- post wind and humidity readings on weather boards; and
- turn in the weather information form at end of race to Chief of Results.

Procedure:

Temperature is an important factor that affects many decisions made during the race day by officials and coaches. Almost as important are the wind speed and humidity; however, equipment to measure wind speed is expensive and is not generally available for use. To provide a good cross-section of the weather condition found on the course, it is necessary in major competitions to provide air and snow temperature readings from each of the:

- high point on the course,
- low point on the course, and
- stadium area.

Readings which should be taken for a thorough study include:

- air temperature in a shady location one (1) m above the snow at each station;
- snow temperature in a shady location one (1) cm into the snow at each station;.
- relative humidity (may not be possible without special equipment); and
- wind velocity at the stadium (may not be possible without special equipment).

These measurements should be recorded at half-hourly intervals commencing two hours prior to the start of the first race. The readings should be taken away from the effects of adjacent buildings and direct sunlight. This recorded data provides valuable information to the Jury in the event of deciding postponements of start times due to cold (below -20°C). Temperatures below -20°C can cause hypothermia, severe frostbite, and/or lung damage due to rapidly breathing in large quantities of very cold air. Coaches use the weather-board information to monitor any changes and trends in the temperature and can then adjust their waxing for later skiers.

The Chief of Temperature Stations may request a controller, (with the permission of the Chief of Controllers), to take the necessary temperature readings at the high point or low point providing they are suitably located and can go out early enough. If not, Recorders will have to be sent out to do these duties. The Chief of Temperature Stations is responsible for taking the readings in the stadium area.

Equipment:

- temperature recording boards (two), radio, thermometers (six required in °C - one for snow and one for air at each location), barometer, temperature recording form, wind-chill chart.

*Temperature Recorders**Reports to the Chief of Temperature Stations*

Temperature Recorders locate themselves at either the high or low point on the course to record the snow and air temperature every half hour, starting two hours before the start of the first race. They continue to report the temperatures to the Chief of Temperature Stations until the last racer has started.

Equipment:

- two thermometers, temperature recording form, course map, radio, light track or racing skis, warm footwear and clothing

Procedure:

Temperature recorders usually ski to their locations on the course early enough to record their first temperature readings at least two hours before the start of the first racer. Their location on course is usually decided by the Chief of Course. They locate their thermometers as described under the Chief of Temperature Stations to provide consistent temperature readings and maintain regular radio contact with the Chief of Temperature Stations. Temperature Recorders must ensure that they do not affect the true temperature of the thermometers by handling them with warm hands, breathing on them, or letting them remain in the sun too long while reading them.

*Temperature/Weather-Board Recorder**Reports to the Chief or Temperature Stations*

The temperatures that the Temperature Recorders gather at each of the measurement points must be radioed to the Temperature/Weather-Board Recorder who will write them on the large board in the stadium area each half hour, beginning at least two hours before the start of the race and continuing until the last skier has started.

For Sprints and Pursuit Competitions – Without a Break, recording on the board should be continued until all heats are finished or the last competitor has left the exchange/pit area to ski the second race. The information on the board, especially the temperature trends, is very important information for waxing, which often continues right up until each racer's start.

SECTION 9: STADIUM DESIGN AND PREPARATION

General Layout

The stadium and its tracks are part of the field of play for a cross country ski race and as such they and the support areas around them must receive major consideration when planning and designing a stadium. The ideal area required for the actual competition requires an open flat space 80+ metres wide and 160+ metres long to accommodate most competition formats. Additional space for timing facilities and spectator viewing is required along each side. The end zone, behind the start line and after the finish line, requires an additional 30 to 40 metres. The actual size for the stadium area will depend on the space available as well as the level, size and type of competitions planned to be hosted on the race site: i.e. local club races vs. loppets vs. Olympic-type events. Other sports using the stadium may also affect the size and design. A day lodge is often located in the stadium area providing additional services and conveniences.

Grooming and track setting of the course in the stadium is the responsibility of the Chief of Course working in close liaison with the Chief of Stadium. Course grooming and track setting details are covered in Section 6.

N.B. For all dimensions given here please check the current Rules.

Stadium Layout Designs

When considering the layout design of a stadium, the biggest issue is how much space do you have and what formats of race do you plan to host. The layouts fall into two general design types, the first being the STRAIGHT “THRU” design, in which the start lanes or tracks access the course at one end of the stadium and the returning course tracks enter the finish lanes or “thru” tracks from the opposite end of the stadium. The second stadium design is the HORSESHOE, in which the start and finish tracks leave and return to the stadium at the same end while the “thru” lanes enter and leave the stadium from this same end but follow the “U” shaped edge of the stadium. The Horseshoe design is more popular for high-performance racing sites because of the exposure offered to the spectators while the racers ski through the stadium on the “thru” or lap track. Note also that the Horseshoe generally has a competitor entrance at the curved end of the “U”, either beneath or over the lap/thru lane. Stadium security tends to be a bit easier with this latter design since the start, finish and “thru” lanes are closed off from spectators.

The stadium design sketches below show the flow of skiers through the stadium area and the location of the various support services for the two major type of events. You will notice that both stadium designs accommodate interval- and mass-start races. This should make them suitable for Team Competitions and Sprints.

Generally, the start line, the finish line, and the line where times will be taken for skiers lapping through the stadium, can be aligned approximately beside each other in the same area of the stadium. However, this is not essential if it is difficult to achieve. Ideally, it should be in front of the timing building so that the timing staff can view all three areas from inside and be able to note bib numbers etc. Timing equipment with wireless technology makes this less essential.

The “Thru” design can have more skier-control problems than the Horseshoe one, simply because access into and out of the stadium is all done on one side of it, usually requiring the crossing of one or more

lanes by skiers moving to the start area or those finishing. Judicious positioning of the start, finish, and lap corridors can reduce/minimize this traffic problem. More will be said about this aspect later. With the Horseshoe layout, if the entrance to the inside of the “U” is beneath or over the through/lap lane, traffic control is much less of a problem. But, if the entrance is actually across the lap lane, then there will be a need for at least two marshals stationed at the point of cross-over to control the traffic in and out, so that this traffic does not interfere with any skiers on the lap lane.

In setting out the stadium for a competition, it is generally advised that a somewhat “permanent” type of barrier be erected to separate the spectators from the competitors and officials. This may be a truly permanent fencing, or temporary fencing that cannot be moved easily by spectators and possibly compromise the competitors. Examples of the latter type of fencing includes the metal sections of fence that hook together (often used by police for crowd control in non-skiing situations), or snow fencing (ensure that there are no parts of such a fence that can injure anyone who comes in contact with it). However, within the stadium, it is highly recommended that the fencing be quite moveable so that stadium grooming and track setting can be performed quickly and easily. This is best achieved with V-boards. Also note that, where space is at a premium in a stadium, one can centre the V-boards (or similar type of fencing) exactly on any dimension mark, rather than having to allow additional space to accommodate the dimensions of the boards. Likewise, survey whiskers (stake chasers) and/or short stick flagging can be used to delineate lanes and lines.

The following pages show diagrams of properly-set stadiums for various start and finish configurations. These should be studied carefully and adapted as closely as possible to the stadium space and design that is to be used for a competition.

Through-Stadium Design

Note that although the diagrams appear to represent classical technique, the same layout applies to free technique but with wider corridors.

Interval Start

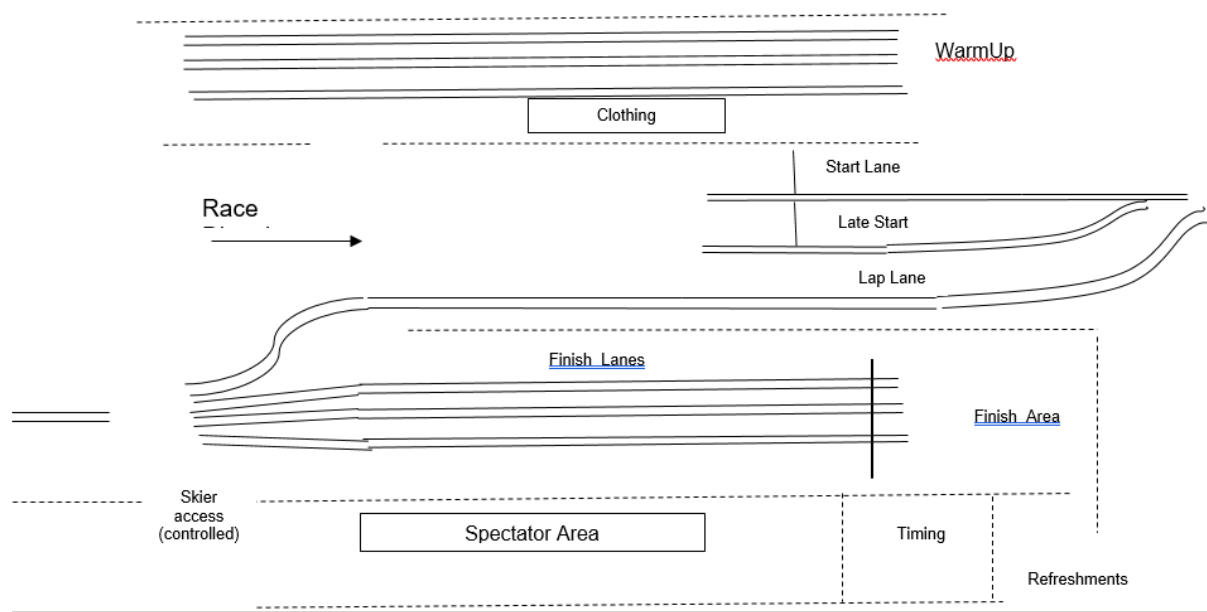

Mass Start

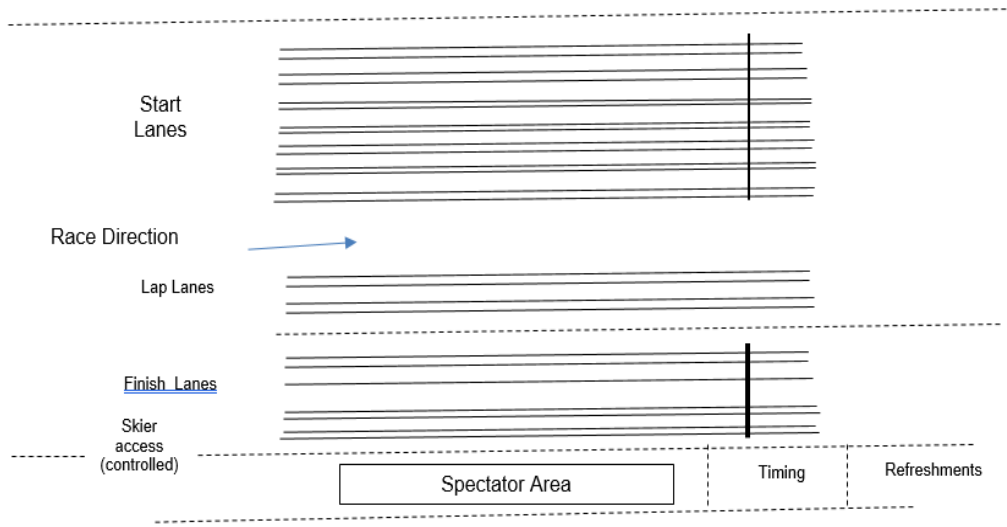

Horseshoe Stadium Design

Interval Start

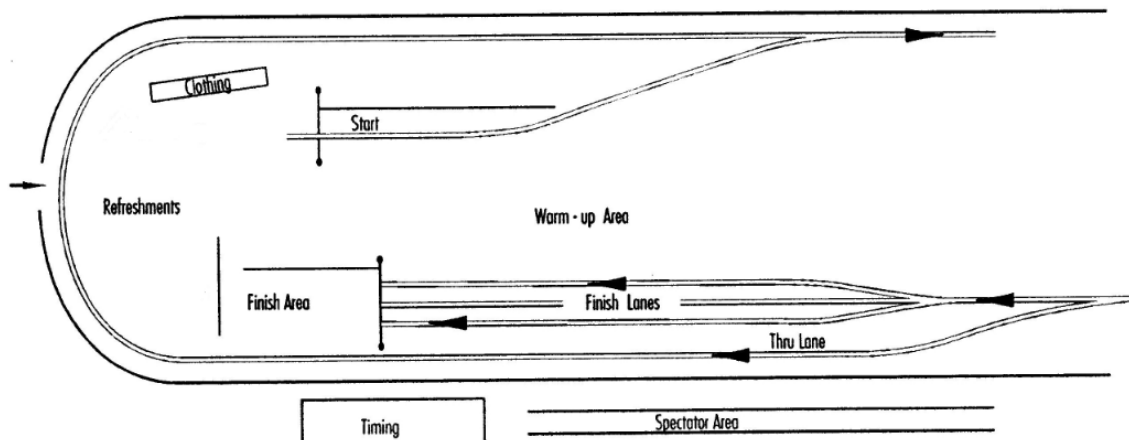

Mass Start

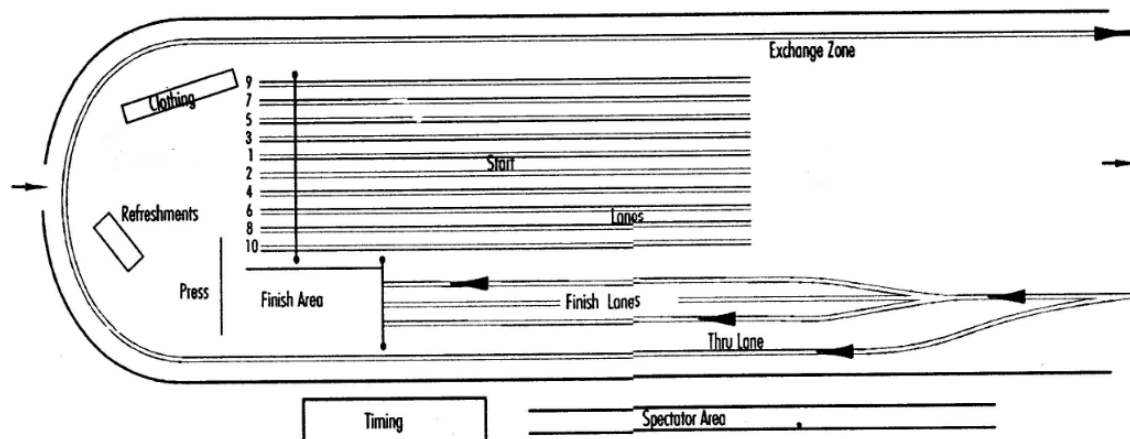

Stadium Layouts - Starts

Overview:

The start area of a stadium has a number of common areas, no matter what the start format is. Competitors should enter the stadium into an area where they go through equipment checking. There should be an area where skiers can ski about to stay warm before they enter the start chute. In this area, there should be a place to check the warm-up clothing that they will shed just before the race. This area should be strictly controlled, because this is where the skiers will do their final preparations for the race, so the fewer the disturbances, the better. Each skier's clothing should be placed in a bag (re-usable shopping bags are great), and the skier's bib number put on it with a stapled paper tag. The bag should then be transferred to the finish area and arranged in bib number order so that a skier can locate his/her bag quickly at the end of the race. Finally, within a couple of minutes of their start time, they will enter the start chute and be ready to go within a very short period of time. If transponders are to be used, it is in the start area they should be distributed to the skiers.

Equipment Control:

Upon entering the stadium, a competitor who is about to begin the day's race must go through a check of the racing suit, the skis and the poles that he/she will be using to ensure that these items conform to the rules and regulations governing dimensions and commercial markings that govern the race. (See www.fis-ski.com, under Rules and Regulations, FIS General Regulations, Equipment, and the Nordiq Canada website). These checks are performed as the competitor enters the start area of the stadium.

The first check that is performed is for commercial markings. The competitor must remove any warm-up clothing that is being worn so that the clothing and equipment checkers can see what commercial markings are on the racing suit to verify that they either do or do not conform to the rules. If the suit does not conform with commercial marking rules, the competitor must be informed of such, and asked to rectify the situation before he/she starts (they can be covered with something that will last the duration of the race, or perhaps the non-conforming markings can be covered by wearing the suit inside out). If the situation is not rectified, the competitor may start the race, but this infraction must be

reported to the Competition Secretary who will bring it to the attention of the TD and the Jury. Commercial marking regulations only tend to be enforced at higher-level televised events.

The skis and poles must then be checked, again to ensure conformity with the rules. Skis must be no shorter than 10cm less than the person's height when the skier is standing on a flat and firm surface - there is no maximum length. Each ski of the pair must also be constructed in the same way and must be the same length. Poles must be no taller than the person's height for free technique events and no longer than 83% of the skiers height for classical events. They also must have a constant length (i.e. may not possess a telescopic system) and may not have any ability to create a foreign energy to favour push-off (e.g. springs or mechanical devices).

Interval Starts

Races using interval starts will have a start line to which each racer will come, stop, and wait for their start time and/or signal. Preceding this line, there will be a waiting area for the next few skiers waiting to start and preceding this, a warmup area. At the start signal, each skier will follow the start track out of the stadium where it will merge with the lap lane, and so continue on.

For free technique races, the start lane should be 3 metres wide.

Beside the start line and extending from it, there must be a late start line and area. This "starting lane" is used for skiers who are late in arriving at the start line at their proper start time to prevent them from interfering with starting skiers who arrived on time.

In the diagrams in this section, it generally shows the lap lanes to be through the middle of the "Thru" design. This is so that, when skiers are on their last lap, they simply have to veer off the main track into the stadium to the finish lanes, while the lap lane continues on to merge with the start lanes. Therefore, the location of the start lanes, by default, are shown to be on the far side of the stadium away from the spectators side. However, there is an argument to be made that, if the lap lane were put on the far side of the stadium (instead of the start area), then the start area would occupy the middle of the stadium. Since the finish lanes should be located next to the spectator/facilities side (for high spectator appeal, better finish timing, and exiting tired racers from the stadium after their finish); then it is possible to have the central area for the start area. Racers entering the stadium to start would enter between the finish and start lanes to the warm-up areas, and with proper fencing would not interfere with either the start or the finish. With the Horseshoe design, the start and finish will occupy the inside of the "U".

Mass Starts

The mass start is usually a very exciting one, but it requires a great deal of space. The chevron layout is used for all mass-start races.

Mass-Start layout – Chevron

Mass Start Chevron Layout

The angle of the sides can be adjusted if the course curves after the start.
Measure from a point in the centre of the course 100m out.
Each row can have an odd number of positions from 5 to 11.
Continue tracks for 10-15m past position #1.

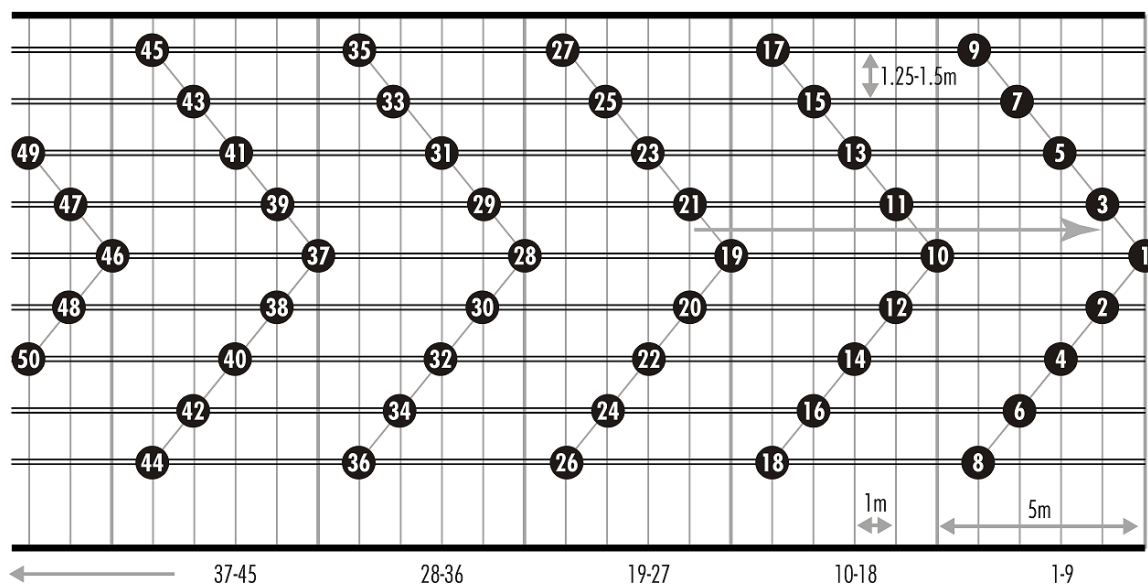

The chevron layout resembles a series of arrowheads, all pointing toward the start line, and all in parallel one behind the other. To obtain symmetry' there needs to be an odd number of lanes. It is laid out as follows:

- The lanes are numbered from the centre lane, this being #1; with
- the 2nd lane being the lane to the right;
- the 3rd lane being the first lane to the left of lane #1;
- the 4th lane being to the right of lane #2;
- the 5th lane being to the left of lane #3 and so on.

(The even numbered lanes are on the right side and the odd numbered lanes are on the left side of the centre lane).

Starting positions are managed as follows:

- The first skier is given the starting position in lane #1 right on the start line;
- the second skier is placed in lane #2, one metre back from the start line of the 1st skier;

- the 3rd skier is given lane #3, one metre back from the start line of the 1st skier;
- the 4th skier is given lane #4, one metre back from the start line of the skier in lane #2;
- the 5th skier is given lane #5, one metre back from the start line of the skier in lane #3;
- the 6th skier is given lane #6, one metre back from the start line of the skier in lane #4 and so on.

Remember, the purpose of the chevron is not to be equally fair; it is to merely to spread out the field of skiers to provide a safer transition onto the course with the highest-possible speed and to minimize the time in the grid for those at the back.

To lay out a chevron, do the following:

- set the desired number of lanes, each with a set track 1.2 - 1.5 metres apart, in the snow;
- mark the start line at the head of the first lane at the point where it is desired; and
- mark the point on each of the outside lanes that will position the skier in the lane.
- Take a rope (or even the tape measure that is being used to do all the measuring), hold one end at the head of the lane #1, and the other end at the point on the outside lane where the outside skier will be positioned, and mark each spot where the rope crosses the lanes between these two points. Do the same on the other side of the start area. These will be the positions of the skiers who will fill in the first chevron.
- Then, move back to lane #1 at the point of the last chevron, and measure down lane #1 behind the start position the number of metres that the farthest outside skier of the previous chevron was from the point of his/her chevron, add one more metre, and mark this spot. This will be the starting position of the first person in the second chevron. Repeat the above process for each chevron. For example: if the farthest outside skier in the first row, or chevron, in the diagram above (see position 8), is four metres back from the first position in lane #1; then the second row or chevron will have to start five metres behind the first position in lane #1.

Start positions can be marked by any number of means, but the simplest is by using 2-inch squares of coloured Coroplast (not snow white!), with the start position marked with permanent marker. They can be fixed in position between the tracks by nails (or screws if the snow is very hard). *Be sure all screws/nails are removed from the snow at the end of the event to prevent them from being hazards to feet, skis and snow machines!*

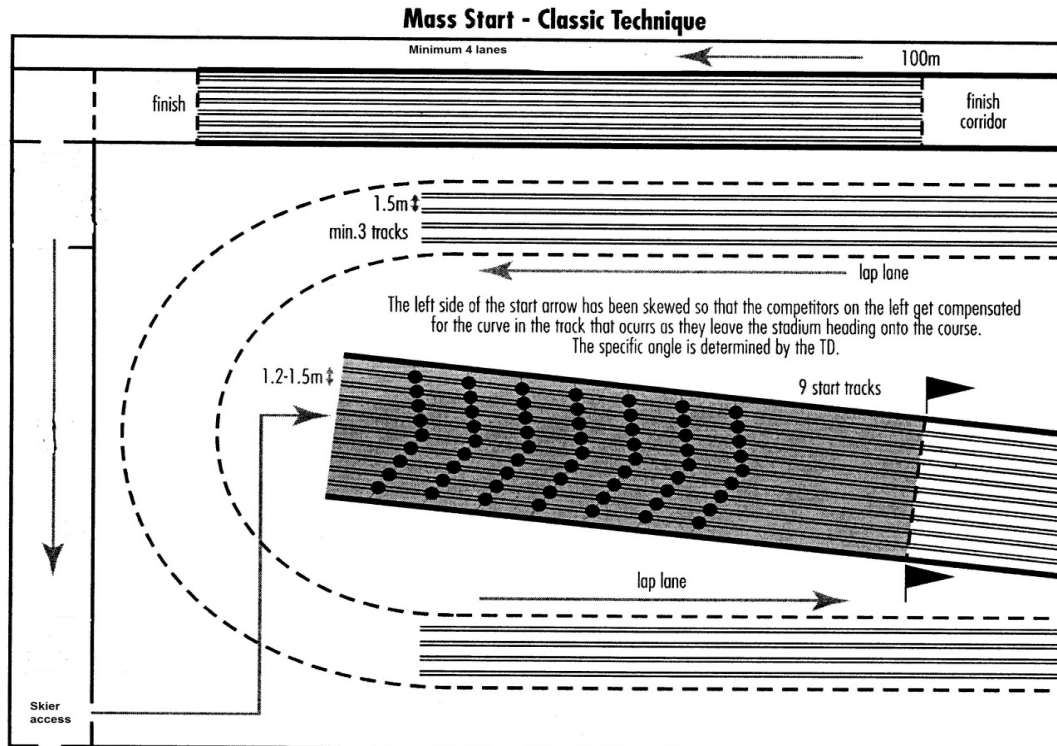

The chevron design has a line where all of the start lanes end. This line is the end of the mass start lanes, and it should be marked in colour on the snow so that each racer is well aware of where he/she can leave their lane and continue in the technique of the particular race. (See the line between the flags in the diagram above.)

Then, there is a convergence zone to the actual racecourse. For a free technique race, it should be about 75-100 metres long, at the end of which the skiers should be into the normal trail width. For a classical race, the convergence zone has a number of sub-zones where the number of tracks gradually decrease:

- Following the end of the mass start lanes, there is a 5-10 metre gap with no tracks set, but the classical technique must continue to be used.
- That is followed by a distance of about 30-45 metres where the number of set tracks is half the number of start lanes.
- This is followed by another gap of 5-10 metres with no set track, followed by another distance of about 30-40 metres with half again the number of tracks.
- Then there should be a third gap of about 5-10 metres after which the skiers are into the main trail.

These gaps are indicators to the skiers that the number of set tracks are continuing to decrease, so they need to be concentrating on making the transition to the reduced number.

Individual Sprint Starts

Individual Sprint Start Line Setup

(prepare 7 lanes – 6 for Heats and one for Qualifying)

15m

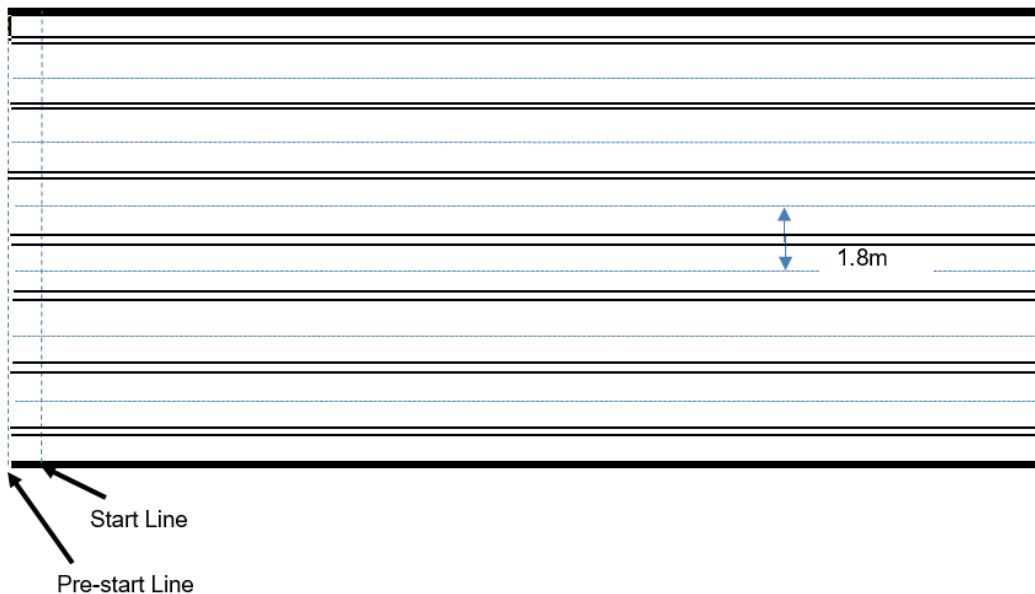

For individual sprint competitions there need to be straight set tracks for the first 15 metres for both ski techniques. The tracks should be a minimum of 1.8 metres apart.

The stadium must contain a start area for interval starts through a start gate in the qualification race; a start area with tracks set to accommodate six racers in each heat of the quarter-finals, semi-finals and finals; and four finish lanes.

There must be a start line from which each heat of competitors leaves after the starter yells “GO” (or fires a gun); and a “pre-start” line about 1-2 metres behind the start line, where the competitors in each heat are positioned before they are ordered to the start line. Behind the pre-start line, there has to be some space to allow competitors to move about while they put on skis and poles and stay warm.

Team Sprint Starts

Team-Sprint starts use a chevron five lanes wide. Straight parallel tracks 2-3 metres apart (depending on technique), run at least 15 metres in front of the first start.

Pursuit Competition

The first race of a pursuit is a standard interval-start race. The results of this race determine the starting time of each racer in the second pursuit-start race.

Each skier in the pursuit (i.e. the second race), will start as an individual in his/her designated start lane. But for that race, it is necessary to determine the number of start lanes required. At a minimum, the number of ties i.e. skiers starting on the same second) needs to be determined. If that number is three, then three lanes are required as a minimum. The next consideration is how far behind the tied skiers will the next skier(s) start. If that is less than, say three seconds, then a 4th lane is required. That time should allow the skier to move forward by one ski length to the start line and be told to “GO” at the right time.

Pursuit

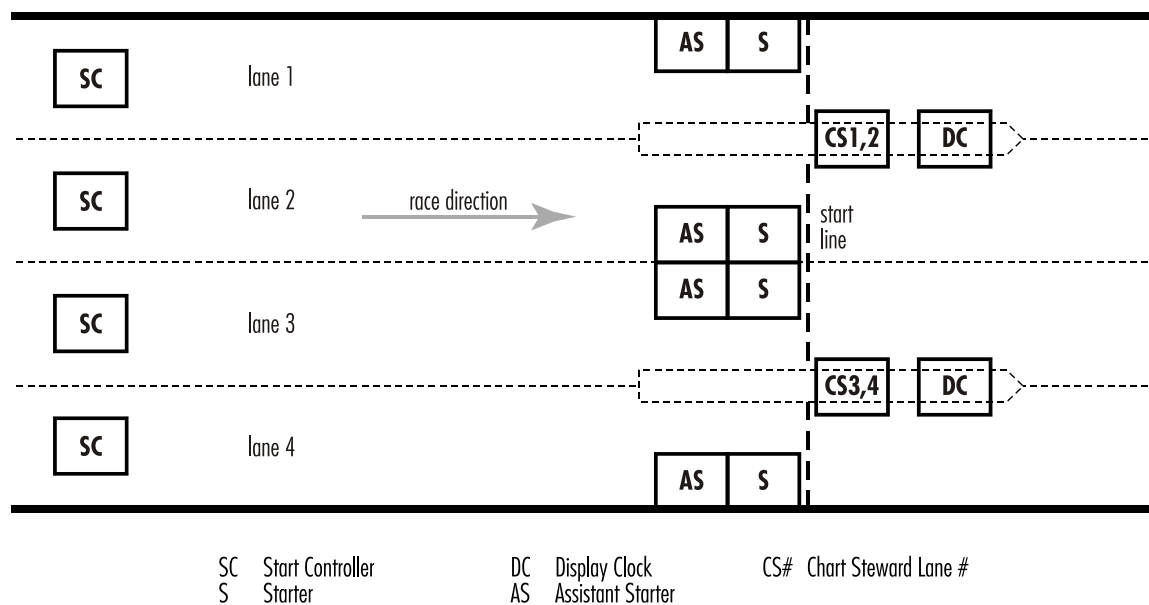

Pursuit Starts

- use three, four or five lanes depending on the time gaps between racers in each lane or the ability of the starters to start racers very quickly;
- use a converging zone - classical technique, reduce the number of tracks by half; free technique, no tracks in lanes or in converging zone; and
- lanes are a minimum three meters wide.

At the head of each lane in view of both the starting skiers and start officials, there should be a display board listing each skier’s bib number and his/her start time, in start-time order. A flip chart will work providing there is little wind or rain/snow falling. As a skier leaves the start, a quick checkmark is placed against the starting skier’s entry on the flip chart. Two display clocks (one as a backup) must be placed in front of the start line and be visible to the competitors and starters so that the starters can release the skiers when the clock time equals the times on the flip charts. An alternative is to equip all start officials with start lists and post that list in the pre-race area. See [Appendix 9](#).

Stadium Layout – Exchange Zones

Exchange Zone – Skiathlon

A Skiathlon consists of a classical stage with a mass start, followed by changing skis in an exchange/pit zone in the stadium, and ending with a second stage using free technique. Therefore, the mass-start setup will be used.

The stadium layout chosen will depend on the shape and size of the available area as well as the number of skiers. Each skier needs an exchange box. One line of exchange boxes uses the least width but requires the greater length. If length is a challenge, then two lines of boxes can be used, but as a result the stadium needs to be wider. Another drawback of two lines of boxes is that less-experienced skiers may go to the wrong side. The following diagrams show the layouts, but are not strictly to scale.

For this competition, an exchange zone or “pit” area must be constructed. This is where the skiers change their skis to go on to the second part of the competition. Each pit must be 2 - 2.5 metres in length and 1.2 - 1.5 metres wide. The V-boards separating the pits should be placed on the 1.5 metre mark and placed at an angle toward the exit end of the pit area to better align the competitors coming into and exiting the pits. The pit should have a non-slip material in it so that skis don’t escape and slide uncontrolled somewhere else; and to provide a non-snow footing for changing boots and/or skis. Along the entry side of the exchange/pit zone, the course must be a minimum of four metres wide, and along the exit side of the pit row, the course must be a minimum of six metres wide. This is to allow space for competitors to get to their pit without having to wait for slowing skiers about to enter their pits. The space requirement between the pits where skiers exit the pits and race to the course needs to be wide enough to accommodate a potentially-large number of competitors emerging from the pits so that collisions do not happen. So, for a two-row pit area, the total width should be a minimum of $4+2.5+6+2.5+4$ metres, or 19 metres; and for a single row of pits, the total width should be a minimum of $4+2.5+6$ metres, or 12.5 metres.

Skiathlon stadium – single row of exchange boxes

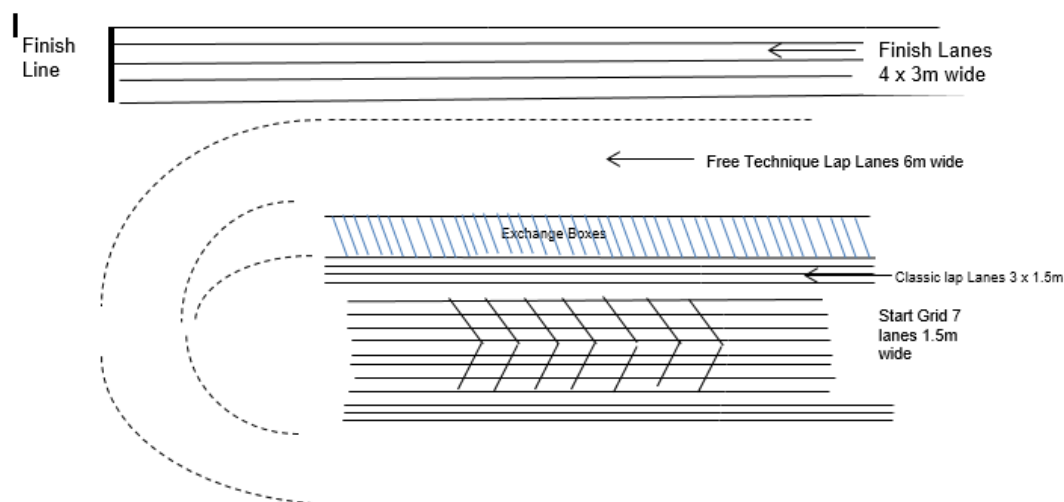

Skiathlon Stadium – 2 rows of exchange boxes

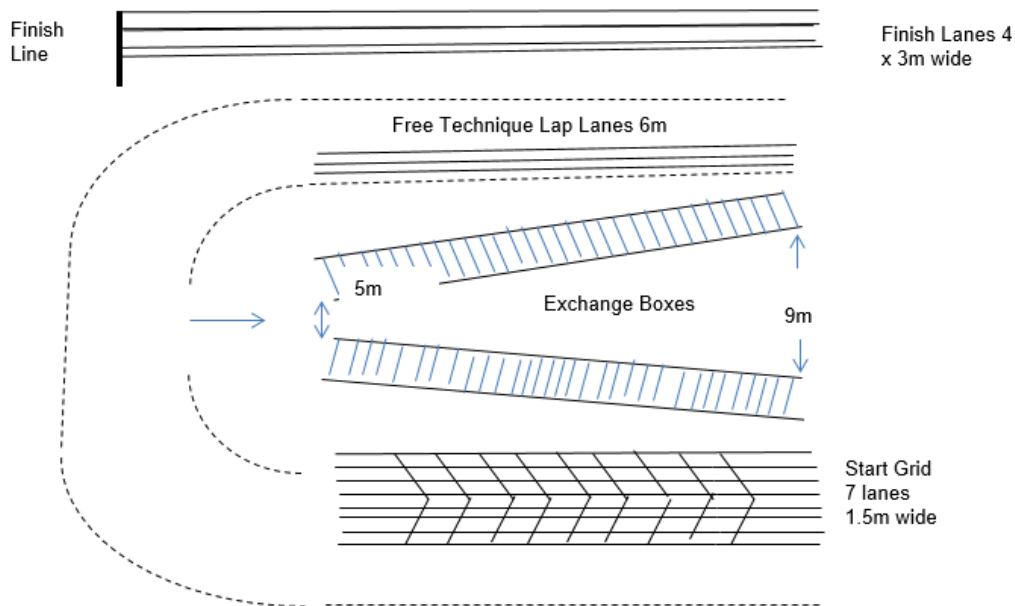

Exchange Zone – Relays

The placement of relay exchange zones must take into account the speed at which racers will arrive - the slower the better in order to minimize potential crashes and maximize the chance of a successful tag. As well, the zone cannot be placed too soon after a U-turn in the stadium. Competitors need time to set up their direction as they enter the exchange. After a curve, everyone is lined up on the inside, so a short straightaway is needed for them to locate their teammates position.

If the competition is in classical technique, then it is suggested that there be no tracks in the Exchange Zone to allow the skiers free passage to find their teammate without tripping over tracks. Bordering each exchange zone, there must be a protected corridor to provide control of the racers entering and exiting the course. The relay exchange zone should be up to 30 metres in length, and 10 metres in width. It is within this zone that each incoming racer must tag off the next skier on their team. The beginning and end of the exchange zone must be marked on the snow in contrasting colours, preferably green for the beginning, and red for the end. If a tag is not done within this area, the fact is recorded and reported to the Jury without delay. The Jury may apply a sanction.

Exchange Zone – Team Sprints

For team-sprint competitions, an exchange zone must be set up similar to that for a relay. It should measure at least 45 metres long and 15 metres wide. The beginning (green) and end (red) of the exchange zone must be marked on the snow in contrasting colours.

Exchange Zone – Para Nordic and Roller Skiing

In these disciplines the skiers do not ‘tag’ each other. For safety (especially considering Vision-Impaired skiers), the incoming course is in a separate lane from the outgoing course. When the incoming skier passes the Exchange Line, the outgoing skier may leave the Start Line. See the diagram below.

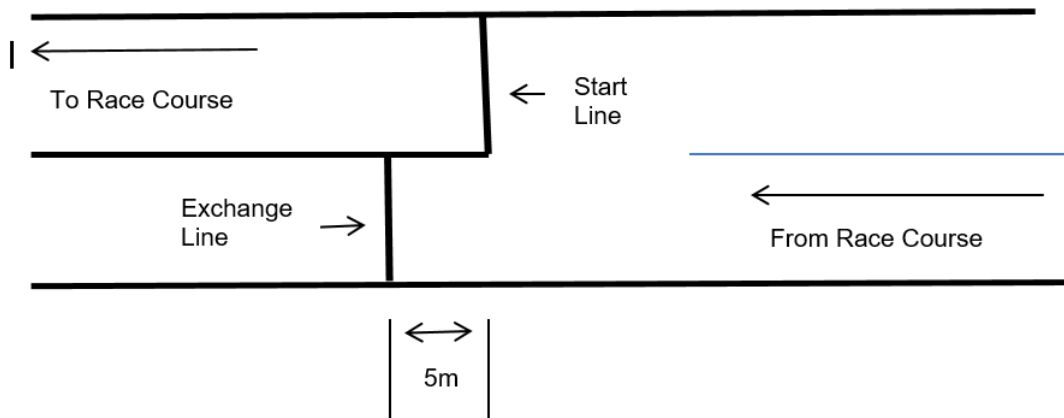

Stadium Area – Finish Areas

The last 80-100 metres before the finish line are designated as the finish corridors. The beginning of these corridors must be clearly marked on the snow with a contrasting colour line; a sign should also be placed on the side indicating the beginning of the finish corridors. The corridors must be straight and preferably placed on a slight uphill grade (2%-4% is ideal). At least three corridors must be provided for interval-start races and four for all others. The edges of the corridors must be clearly marked and highly visible, but not marked with anything that might interfere with the skis. Many race sites are using things called “stake chasers” or “stake whiskers”, used by surveyors to mark lines and boundaries. They are like long nails with a coloured, stiff tassel at the top that sticks straight up about 12-15 cm. They are pushed into the snow to mark the edge of each lane. A portable drill with an auger bit, or even a large nail driven into the snow with a hammer, is often used to make a hole in the hard-packed snow base to receive the whiskers.

For classical-technique races, each corridor should be about 1.5 metres wide, with a track set down the middle. For free-technique races, the corridors should be three metres wide thus requiring a minimum width of nine metres.

It is extremely important that the transition from the course to the finish corridors be set so that the best line to the finish line is in the middle of the finish corridors. This means that the two outside finish corridors will be only very slightly less advantageous (slightly further to get into) to the racers. The best line to the finish should not be one of the outside lanes, making it much farther to get to from the other outside lane, and thus requiring a racer to have to ski further to get to the finish line. In setting up the finish zone, it is mandatory that one stand back on the trail at the entrance to the stadium as if he/she were a racer, and mark the direct line to the finish first; this will be the middle corridor, and the other two corridors can then be added to each side of this middle one. There can be no compromise on this aspect of setting up the finish corridor.

The finish line must be marked either on the snow or with a strip of solid straight material set below the surface of the snow so that it doesn't touch the skis as they cross it. The finish line can be a maximum 10 cm wide and should present a visually-sharp leading edge to the viewer and camera.

The finish area after the finish line should be fenced to keep out spectators, and to provide an area for first aid, refreshment, and clothing retrieval. There needs to be a gate, strategically positioned, to allow the racers who have finished to exit the area away from anywhere within the stadium where their path might interfere with skiers about to start their race.

There needs to be room in the stadium near the finish line to position video cameras to help determine the finish order; such that a clear view is afforded to the cameras without interference from spectators and officials.

Stadium Layouts – Lap/Through Area

The lap lane(s) or through lane(s) are necessary in order for skiers to pass through the stadium area so that the spectators can see them a number of times; and to capture an elapsed time that informs spectators and other interested people about how each competitor is doing in the race (i.e. who is first at this point, who is second, who is gaining on other skiers etc.). The lap lane must be placed in a location that provides spectators with a good view but does not interfere with starting and finishing racers. The diagrams on stadium design should be studied to determine the best layout of this lane with respect to the shape of the stadium that is on the site.

For the Horseshoe stadium, the lap lane is generally situated around the outside of the "U", thus not interfering with the start and finish. Where the entrance to the stadium for starting and finished skiers is from the end of the "U" (under, over, or across the lap lane); then there should be no interference with the lapping skiers. However, where the stadium is of the Straight "Through design, then it is possible that the starting or finished racers could interfere with this lane as they enter the stadium to start or exit the stadium after finishing. Therefore, if possible, the lap lane could be placed along the area of the stadium farthest from the spectator area, so that entering and exiting the stadium would not involve crossing the lap lane. Otherwise, the crossover point will need to be staffed by sufficient marshals to ensure no interference with lapping skiers.

Stadium Layouts – Other Areas

Feed Stations

Some racers will have a great deal of difficulty breathing after finishing. Often the first thing that can help them is to have them slowly drink some warm liquid, which tends to open the throat and allow better breathing. The finish-area feed station must, therefore, be close to the finish line but not in the way so that skiers can take liquids to replenish those lost during the race.

On-course feed stations should be provided during any race longer than 15 kms. Ideally, there should be a refreshment station every seven or so kilometres (plus one in the stadium). The stadium lap lane can be considered as an option for a feed station, but it is better to have a location with a long gradual (fairly straight) downhill section that follows the feed. This allows the racer to take in fluids while relaxed and not needing to worry about losing too much speed.

With the increase of mass starts in the long distance races, “high-capacity feeding” has become a common requirement. See the diagram below which illustrates one such solution for a classic competition. During Mass-start races the feeding officials must stand still and cannot run beside skiers. Longer and wider spaces are required with the accommodation for through lanes off to the side.

High-Capacity Feeding Station - Classic

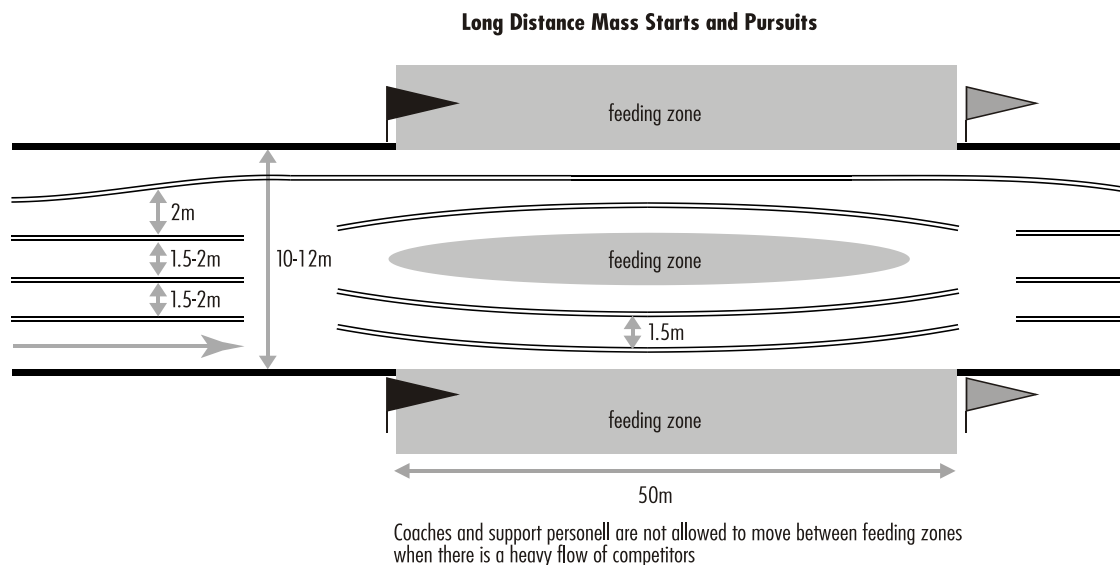

Clothing Pickup Area

A clothing station must be established in the finish area after the finish line. Clothing should be transported from the start area in bags marked with the skiers’ bib numbers. The best setup is a rack, or series of racks, on which the clothing bags are hung.

Ski Preparation, Testing and Warmup Areas

The athletes’ compound should be located near the stadium, the wax-testing area and the warm-up area; and should be fenced off and made secure from non-team personnel. Over-night security should be provided. The athletes’ wax cabins may consist of permanent rooms, cabins, trailers, or tents. Inside, there should be several electric power outlets, adequate heating and ventilation, shelves, and if possible, the ability to attach ski holders to the walls. Below are considerations event organizers must keep in mind when planning and setting up ski preparation areas:

- an outdoor area adjacent to the stadium should have a fence or rail along which electrical outlets can be mounted to provide power for waxing irons;
- enclosed tents or team rooms must be well (force) ventilated for waxing smoke and fumes from fluorocarbon waxes. If fluorocarbons are being applied, access must be restricted, and approved masks must be worn;

- at least two 15-amp power receptacles should be provided to each team for ski preparation - for irons, power brushes, etc.;
- open flames are prohibited in tents and around fluorocarbons; and waxing iron temperatures must be kept down to the manufacturer's recommendations;
- fire extinguishers should be located in each team room or tent;
- toilets should be adjacent to waxing areas or team rooms in sufficient numbers; and
- sufficient space should exist around the outside of any waxing rooms or tents to allow people the space to get away from the immediate area of any fire.

Stadium Equipment Details

Weather Board

The weather board should be constructed out of material such as G1S plywood, corrugated plastic or Coroplast. The surface must be made weatherproof and be suitable for writing on. The use of a high-gloss, white enamel paint serves both purposes. Draw lines and headings in black on the board. Cover the board with clear polyethylene and write weather information on the poly with a felt pen or a wax pencil. The plastic can be cleaned later using lighter fluid or Varsol for reuse or be replaced. The wax pencil can be dry-rubbed off with a piece of facial tissue. A minimum of eight, eight-centimeter (3.5 inches) rows are required. The weather boards are to be located near the ski-waxing area(s) and in the stadium warm-up area.

Time	Air Temp			Snow Temp			Humidity	Wind Speed / Direction
	Stadium	High	Low	Stadium	High	Low		

Official Notice Board

An Official Notice Board is required to post the unofficial and official results listings at the end of each race. This board must be in a prominent location having easy access for competitors, coaches and spectators. The board should be approximately 122 centimeters (48 inches) square and made out of a

soft plywood or cork board to accept thumb tacks or staples. A sign “OFFICIAL NOTICE BOARD” must be positioned across the top.

Fencing and Dividers

Fencing provides a good security barrier and access control around the outside of the stadium to keep spectators and other non-competitors out of the stadium area. The right fencing, though heavy, can be quick to set up, move, and take down. The sections are best if stackable, making them easily moved on a trailer and stored. Banners may be hung on the fencing (although the fences must be sufficiently-well supported to ensure that they do not blow over if there is any wind). Suggested fencing includes the type in the diagram below, or the metal sectional fencing that link to each other, often used for crowd control by police and security agencies. With the latter type of fencing, it can be easily moved by turning it upside down and sliding it along the snow.

The inside of the stadium should be marked with the use of V-boards. These are generally molded-plastic boards shaped in an upside-down V form approximately four feet long, and painted in highly-visible colours (red, blue, black, green, etc.). Often, they will have one end closed – this end is placed to face the direction of the oncoming skiers so they can be seen better. They can be stacked for easy storage, are easily movable, and can be positioned anywhere quickly. It is hard to imagine a stadium setup without the use of V-boards. With their ease of mobility, they can be quickly stacked at the edge of the stadium so that the large grooming equipment can groom and set track in the stadium without obstruction. The V-boards can then be easily moved back into place. A molded-plastic snow toboggan is useful for easily moving stacks of V-boards over the snow.

Start / Finish Posts and Banners

Start and finish banners can be either a vertical or horizontal design. The latter is often stretched across the start and finish lines between poles. These poles must be very well anchored so that any wind does not topple them on top of competitors or officials. The vertical ones are each on their own vertical support structure. In any case, having wind holes in various places on the banners themselves will cut down on the wind drag and reduce the chances of them being blown over. An alternative is to have four plywood boxes 3'-4' high and 12" square with 2 x 4 feet on which a sign for Start or Finish is attached. These boxes are then positioned at either end of the respective line.

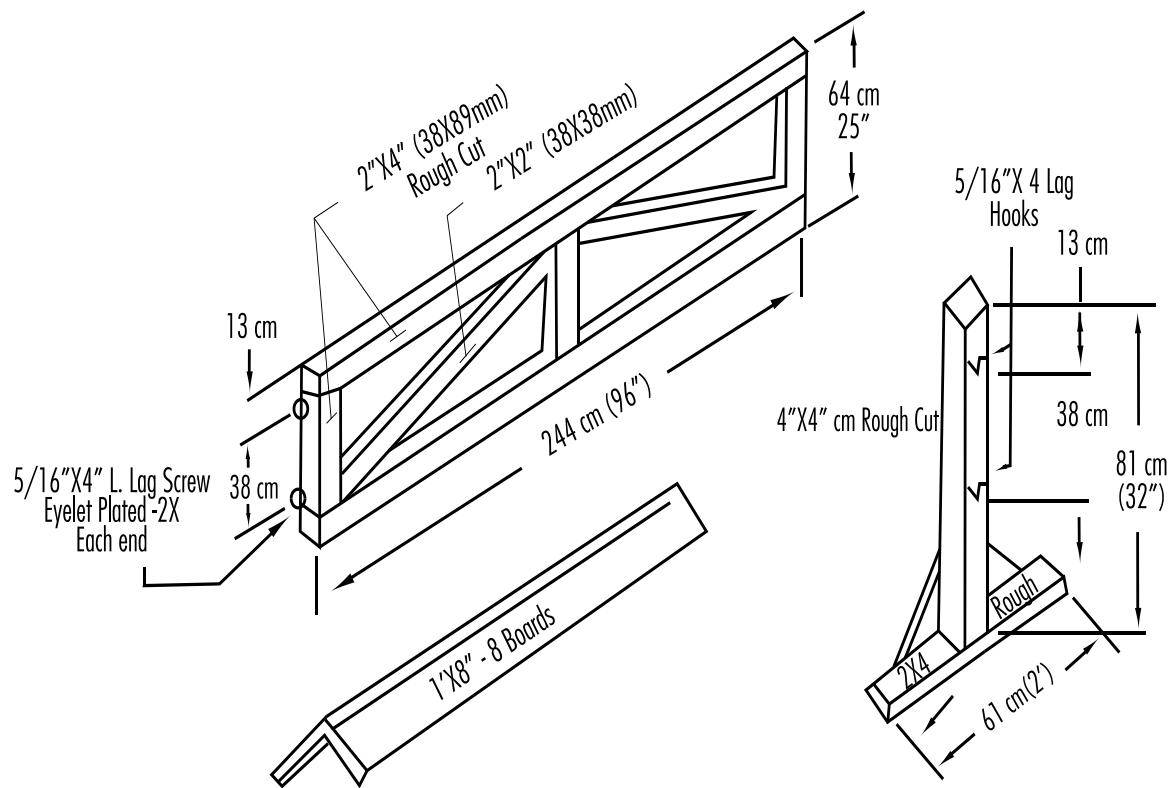

An illustration of possible wooden fencing (top), v-boards (bottom left) and start/finish/banner post dimensions.

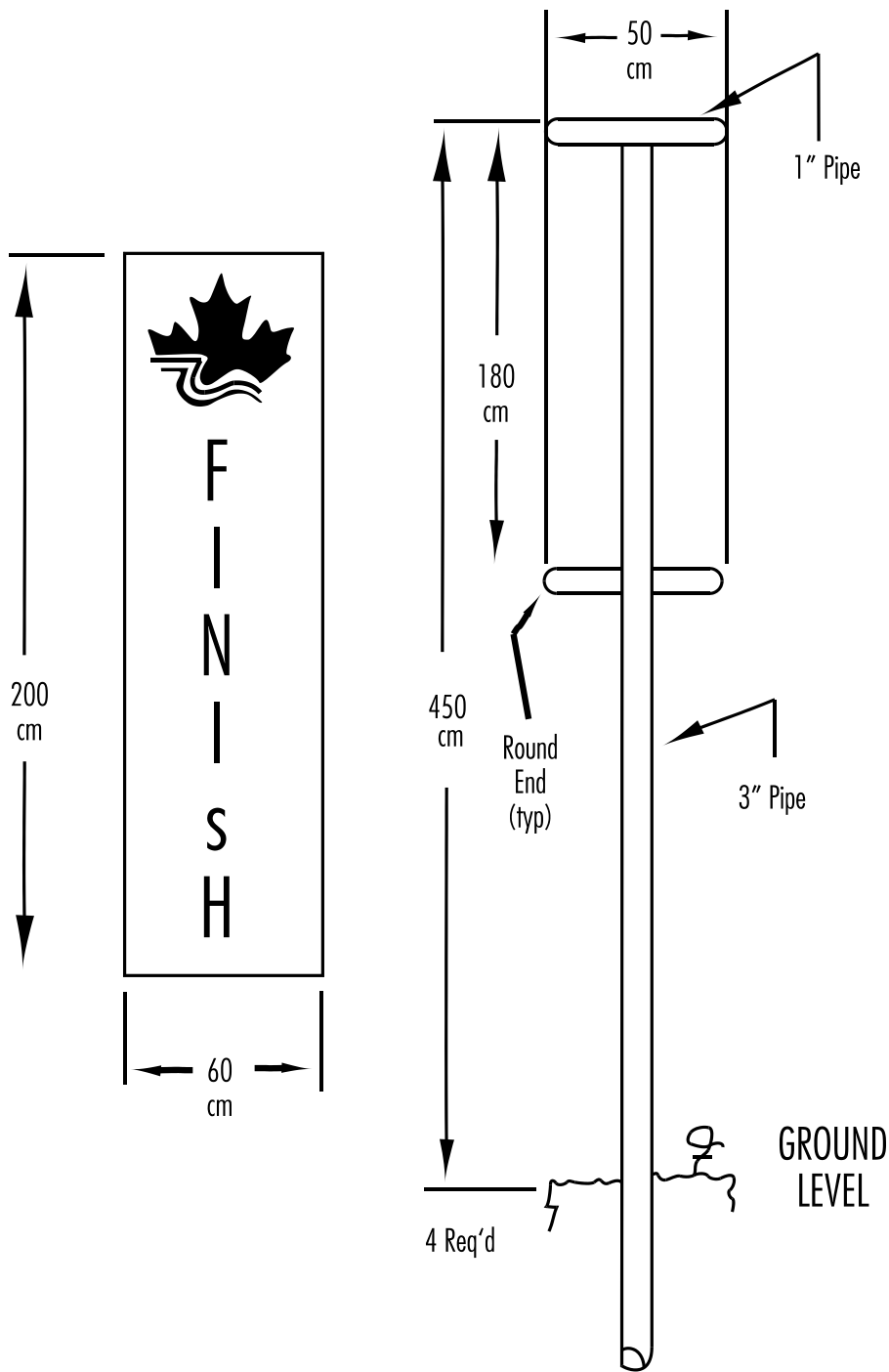

An illustration of possible banner post dimensions.

Transponder Racks

Racks with transponders (chips) need to be positioned at the start where the transponders can be distributed.



Sponsor Banners and Signage

Signage located in the stadium area for the competition must include the following:

- “Thru/Lap lane” / “Finish lane” signs for the lap/ finish intersection. See below.
- Relay “Exchange Zone” warning sign to be positioned 40 to 60 meters before the exchange zone.
- “Start of Exchange Zone” and “End of Exchange Zone” signs.
- Indicators for the beginning of the finish corridors (80-100 metres before the finish line).
- “Weather Board” sign if not on the weather board.
- “Results Board” sign if not on the results board.
- “Official Notice Board” sign if not on the Official Notice Board.
- Directions to and from the “Wax-Testing Area”.
- Start and Finish banners.
- Lane/row markers for mass starts.

- “Refreshments” sign in the finish zone.

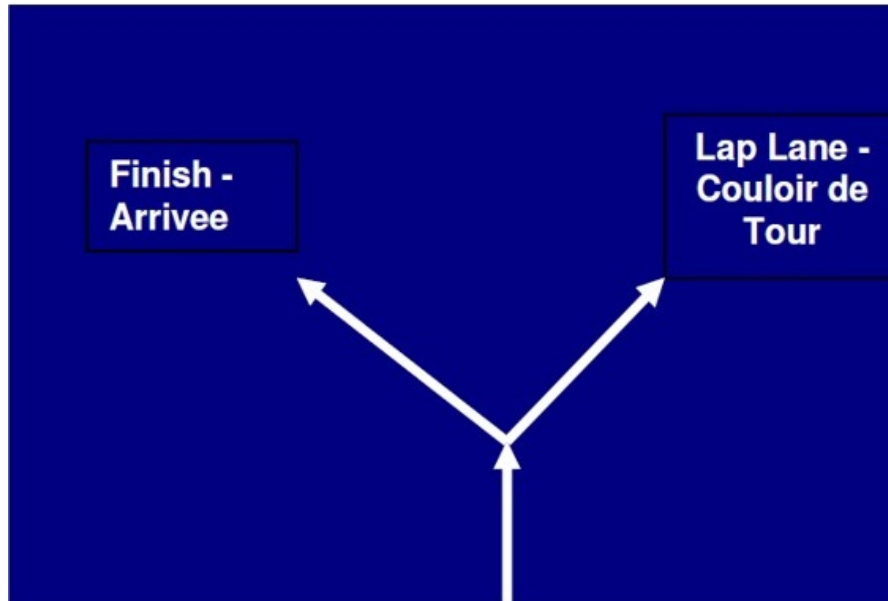

Position a sign as above approximately 100m before the decision point preferably on an uphill or flat section where skiers speed is limited. There should be another sign at the decision point.

Start and Finish banners may be made in two designs, the horizontal banner, and the post or column banner. The two designs each have advantages and disadvantages. The horizontal banner is strung across the start and finish lines. They must be strung high enough to allow grooming equipment as well as skiers to travel under them. The horizontal banners present some problems in wind. Extra bracing may be required where light-weight posts have been used. Horizontal banners do provide a great atmosphere. The post style banners are made in the shape of a sack and slip over a frame built on the post. The post style is easier and quicker to set up, provides no overhead obstruction, and is less affected by the wind.

Sponsor banners are traditionally strung along the permanent fencing of the stadium and at prominent places around the course. Those people tasked with hanging the banners must be aware of the location criteria in that larger sponsors are put in positions providing the best exposure. For example, if the event is televised, the largest sponsor's banners should be hung on the fence just past the start area where the cameras will pick up the banner with each passing skier. It is important that all sponsors get the best exposure possible. These are often put up with plastic zip ties that can later be cut with snipper pliers for quick removal.

Timing Buildings and Placement

For major race venues, it is often the case that a special timing building is on site. It can be built to allow for the finish-timing crew to have a front-window view of the finish line, enabling them to see the bibs of the racers who cross the finish line, to verify signals that come through from the finish line, etc. However, with the use of wireless timers positioned at the finish and lap lanes, visibility from the timing building is less critical. It is also often used to house the announcing team since they will be able to have

an excellent view of the whole stadium area and be able to create excitement during the race. At other sites, there may instead be a few smaller buildings spread around the site to provide the same functions.

In this sport, protection from the elements, the distractions of the traffic, and the bustle of the race are the most common reasons for providing these buildings. The electronic equipment that is now being used, such as computers and printers do not perform as well or as long outdoors in below-zero temperatures as they do in warmer areas. So these buildings provide warmth for not only the timing and results equipment but also for the people who operate and/or monitor them. The buildings should have some kind of heat in them, perhaps electric heat or indoor propane heaters. If direct, hardwired electricity is not available in these buildings, then generators operating outside are usually used - at least taking the chill off the place.

The one function that can be very disturbing to the timing and results people is the announcing team. With powerful loudspeakers broadcasting results, music, information about various competitors, upcoming events, etc., the noise can be a huge distraction and disruption. Be careful where the building sheltering the announcing team is located in the stadium area so that it does not become a distraction to the timers.

Announcer Area

An announcer with a support team can add a great deal of excitement to a race. If used well, the announcer can keep the spectators current on who is leading the race, can point out the leaders as they pass through the stadium, and can give some very interesting biographical information about competitors. In addition, the announcer can keep the competitors who are waiting to start informed as to the time of the race so that they can be ready on time. When such functions are carried out well by this team, the announcing function is a great asset. Computers on the Timing and Scoring network can provide up-to-date information for announcing as can tablets with internet or intranet access.

However, if announcing does create a lot of noise, disturbing the timing aspect of the competition, then something needs to be done. Some possible solutions are to locate the announcer at a bit of distance to those functions that require little distraction, to direct the speakers away from the location of the important functions, or to even turn down the volume a bit. The announcing area needs some very serious plans to make it successful while minimizing the disturbances in the timing and results area.

If all is wanted is to identify skiers in to start and finish lanes, a wireless microphone with a roving announcer is very effective.

SECTION 10: STADIUM OFFICIALS

The Requirement

The stadium area is always a hive of activity, and a variety of Chiefs operate in or around this facility. Therefore, it is mandatory that each stadium function have only one Chief, so that officials know from whom they are to take their instructions. It is not being suggested here that there are battles over whose turf items belong to, as cooperation is very important; but having too many people directing too few people can be a problem.

Some of the Chiefs who do operate here include:

- Chief of Stadium –oversees the stadium planning, setup, grooming, and security.
- Chief of Course – oversees the grooming and track setting in the stadium and ensures that there is a smooth transition from the course to the stadium and back out onto the course.
- Chief of Timekeeping and Scoring – ensures that the timing equipment is set up and working in the stadium area and assigns people to the timekeeping and results positions.
- Competition Secretary – works within the stadium area, handling bib management, protests, minutes and record keeping.
- Chiefs of Start/Finish – assigns people to the start and finish positions in co-ordination with the Chief of Timekeeping.
- Chief of Competition Security – assigns marshals around the stadium area in co-ordination with the Chief of Stadium.
- Chief of Medical Services – co-ordinates the first-aid teams and any other medical services that seem appropriate.

Chief of Stadium

Reports to the Chief of Competition

Oversees the following:

- Chief of Stadium Preparation
- Chief of Relay Exchange Zone (in close liaison with Chief of Competition Equipment)
- Chief of Equipment Checking
- Chief of Finish Line

The Chief of Stadium is responsible for overseeing the stadium planning, setup, grooming, and security to meet the competition's technical and safety standards. Of prime importance is the smooth flow of skiers to and from the start and finish area.

Duties:

Pre-race:

- design stadium layouts, in co-ordination with the Chief of Course and the Chief of Timekeeping;
- produce stadium layout sketches;
- co-ordinate stadium grooming with Chief of Course;
- assign banner-posting space;

- supervise competition equipment procurement with Chief of Competition Equipment and Chiefs' committee;
- develop budget for equipment and supplies required;
- provide training for stadium officials, and position marshals in stadium area in co-ordination with the Chief of Competition Security;
- assist with wiring installations for timekeeping and announcing in co-ordination with the Chief of Timekeeping;
- plan medical services, and if required, doping control operations, with the Chief of Medical Services;
- plan for awards podium, etc.;
- supervise stadium setup for official training days; and
- supervise stadium setup for competition days.

During Race:

- supervise stadium personnel and troubleshoot problems;
- maintain stadium security through the Chief of Competition Security;
- maintain verbal or radio communication with Chief of Competition, Chief of Timekeeping, Chief of Course, Competition Secretary, and for a major competition, Chief of Competition Security; and
- keep a close tab on racer progression to the start line.

Post-race:

- arrange future stadium preparation;
- dismantle facilities and provide for their storage or transportation;
- arrange for next-day grooming; and
- debrief with all sub-chiefs

Equipment

- clipboard, radio, start list

The Stadium is the showplace for the sport of cross country skiing. The Chief of Stadium has the job of setting the stage to show the speed and excitement of the sport!

Procedure:

This job requires attention to detail to arrange the start, finish, and thru lanes to allow the skiers to be as close to the spectators as possible yet ensure effective officiating of the competition. (See [Section 9](#) for stadium design information). The effective placing of banners, flags, stadium fencing, and dividers provides an attractive site for spectators, skiers, officials and media, and makes a cross country ski race an enjoyable ski experience for all involved. A well-arranged and organized stadium provides a smooth flow of skiers to and from the start and finish area.

The Chief of Stadium must plan the layout for each type of race carefully, including tracks, start and finish areas, press areas, refreshments, clothing storage and handling, and the warm-up area before the start line. The number of fences should be kept to a minimum but should provide good control of all areas. Once the skier enters the stadium, he/she should never be in doubt as to how to get to the warm-up and start areas.

Two levels of stadium setup are required for any event. On the official training day(s) prior to race day, the stadium must be set up to show the racers exactly where the start, finish and thru lanes will be for the race. In addition, basic fencing and all directional signing should be in place identifying exchange zones, etc. On race day, the full stadium setup is required with all signage, fencing and support facilities in place.

Skiers who are not competing and spectators must be kept out of the inside stadium area. Officials having no official stadium job must also clear this area to allow an unobstructed view of the racers and reduce distractions for the stadium officials. To help effect this, the stadium is often closed to all traffic at some appointed time prior to the race start, e.g. 10-15 minutes before the first skier is started. This allows the stadium officials to get and be organized, and to begin the process of getting racers into and through the pre-race preparations that precede their actual starts.

Chief of Stadium Preparation

Reports to the Chief of Stadium

Oversees the following:

- Chief of Competition Equipment
- Stadium Set Up Crew
- Chief of Feed Stations

The Chief of Stadium Preparation manages the physical setup of the stadium area according to the designs prepared by the Chief of Stadium.

Duties:

- work with Chief of Competition Equipment for the procurement of equipment for the competition and race site;
- arrange with work crews for the installation of semi-permanent and permanent facilities;
- arrange for equipment and supplies and for secure storage facilities for them;
- arrange for the setup of stadium fencing, barricades, stands etc. according to the plan;
- set up refreshment serving tables etc.;
- arrange for the hanging of all sponsor banners in stadium area according to the plan;
- manage stadium changes during the race;
- monitor the stadium setup during the race to maintain operational effectiveness; and
- oversee dismantling the stadium area at the end of the competition and returning all equipment to its required place.

Equipment:

- clipboard, radio, snow or solid fencing, pop-fencing, start and finish posts and signs, flagging, signage, shovels, rakes, basic carpenter tools, open-end wrench set, screwdriver set, sledgehammer, snow drill and rechargeable electric hand drill, snowmobile or ATV, trailers, sleds, line marking liquid.
- Remote, non-serviced sites also require electric generators, transport toboggans, small heated buildings (for timing, calculations and Competition Secretary), waxing tents, volunteer tents, transport van(s) if not done by the Chairperson of Venue Planning & Services.

Procedure:

The Chief of Stadium Preparation duties may start very early in the preparation for an event depending on its size and the state of readiness of the stadium and equipment already available. Tasks such as the burying of wire for timing and sound systems may necessitate digging ditches in the summer or fall prior to the event and running plastic pipe and pulling wire or pull cords to install the wire later. Permanent fencing to secure the stadium periphery should also be installed during frost-free periods. It is his/her responsibility to oversee the installation of this equipment. The Chief of Stadium Preparation must do a thorough analysis of the equipment required for the event(s) planned; take inventory of stored equipment and supplies; check the availability of needed items; and inform the Chief of Stadium and Chief of Competition Equipment of the required items. He/she must organize the setup of the stadium area for training and competition days and work closely with the stadium-setup crew ensure that all is completed on time and correctly.

Chief of Competition Equipment

Reports to the Chief of Stadium Preparation and liaises closely with the Chief of Stadium

The Chief of Competition Equipment is responsible for acquiring the necessary stadium and course equipment for the event as requested by major officials.

Duties:**Pre-race:**

- procure the equipment assigned;
- organize the transportation of equipment and supplies to the race site;
- organize the secure storage of equipment and supplies on site;
- check operation of stored and procured equipment;
- check for and secure backup equipment and supplies as required; and
- distribute tools, equipment and supplies to the required areas or to volunteers and officials for use and set up on training and race days.

During Race:

- trouble shoot any equipment problems and arrange for maintenance if necessary;
- check fuel supplies in operating equipment;
- check-in equipment not needed during and after race; and
- maintain radio contact for problem solving.

Post-race:

- check-in equipment, return it to storage or arrange transport back to suppliers;
- check radios and recharge if needed for the following day(s); and
- check all returned equipment for damage and arrange for repair.
- as small as office supplies and drink cups.

Procedure:

This position is of major importance for large events where a lot of special equipment is needed. Early in the organizing process (at least six months before the race) the Chief of Competition Equipment must meet with the Competition Committee to discuss the following points:

- review equipment list (See Appendix 1);
- determine who is responsible for acquiring needed equipment;
- determine quantities needed; and
- establish sources of equipment and budget for rentals and purchases.

At the beginning of each training and/or race day set up to distribute supplies and equipment in an organized manner. Check to be sure there is some back-up or extra equipment for the critical areas: for example, extra batteries, shovels, ropes, flags, posts and tools to do the jobs. When issuing the equipment, ensure it is in good working order. At the end of the day, check that the equipment is returned and stored in good working order. Equipment should be recharged and tested or sent for maintenance, when necessary. Rented equipment must be returned promptly to minimize costs.

Equipment:

Clip board, inventory record book or system, radio. This list will include any equipment the Chief of Competition Equipment must manage. It can include items as large as tents, grooming and track setting equipment to items as small as office supplies and drink cups.

*Stadium Set Up Crew**Reports to the Chief of Stadium Preparation*

The Front Line Crew sets up all of the fencing, flagging, barricades, stands, and banners required in the stadium area prior to the competition. This is a physical job requiring people who will arrive early and stay through to the end of the race day when everything is dismantled and returned to storage.

Equipment:

- See [Section 10](#) - Chief of Stadium Preparation, Equipment

Procedure:

The set up crew normally arrive two to three hours before start time on training days and at least three hours before start time on race days to first set up the stadium fences, barricades and lane dividers to give shape to the stadium.

On race day they set up tables for equipment checking and ski marking, the refreshment areas, and start and finish banners and signage required for the day. All banners are hung in the designated places. When requested to do so, they assist with setting up the electronic timing area and undertake any special tasks

to complete the stadium preparations. This crew also sets in place the start line posts on which the timing equipment will be placed. In addition, they set up signage for directing racers through the stadium (i.e. the “lap lane” signs, etc.), and establish all extra lines in the snow in the stadium area, such as exchange-zone lines, the lap-timing lines, etc.

Stadium setup must be complete a minimum of one hour before start time.

During the competition, the crew monitors any special requests as the race progresses. When the start is completed, they dismantle or adjust fencing in this area and return what can be returned to storage. After the competition or training is complete, they dismantle the stadium to the appropriate level and store equipment. The crew assists with the setting up of awards ceremonies as required.

Chief of Equipment Checking

Reports to the Chief of Stadium

Oversees the following:

- Clothing and Equipment Checkers
- Clothing Stewards
- Transponder Distributors

The Chief of Equipment Checking is responsible for ensuring that: (1) all of the competitors’ clothing markings are within FIS/CCC regulations; and (2) that the equipment to be used meets FIS/CCC rules and regulations prior to each skier starting to race. A record must be kept (usually a check mark on a start list), which indicates that the clothing and equipment conform to the rules and regulations. Any infractions must be noted. In addition, he/she is responsible for managing the collection, storage, and return of skiers’ clothing.

Clothing checks include warm-up and competition clothing which may be checked at any time.

Procedure:

The Chief of Equipment Checking, with his team of Clothing and Equipment Checkers, ensures that all clothing that racers wear and the equipment that they will use conform to the rules and regulations of the sanctioning body for the competition. He/she also works with the Chief of Start /Finish to organize and set up a system for the collection, storage and return of racers’ clothing during the event. The checking of clothing and equipment is the area where the Chief of Equipment Checking often works directly with the racers as the rules governing these areas must be strictly enforced.

A standing board a minimum 50cm (2 ft.) square, clear-plastic measuring templates representing the maximum area allowed for each size of crest, (two or three configurations for each size area), a copy of the latest regulations

After equipment and clothing checks, the skiers proceed to a stadium warm up area to continue warming up until start time. When skiers return from the warmup area to the start line, they will take off warm up suits and extra clothing and give them to a Clothing Steward. The system for storing this clothing may be shopping bags with the skier's bib number affixed to it. The bags are then hung on a secure storage rail with spikes or pins to keep them out of the snow; or on storage shelving units with a

cubby hole for each skier's clothing and a place to write the bib number on the shelf - or any other similar system.

Clothing and Equipment Checkers Reports to the Chief of Equipment Checking

Clothing and Equipment Checkers are responsible for ensuring that all clothing worn, and equipment used, by the skier conforms to race regulations.

Procedure:

Clothing and Equipment Checkers physically measure the various crests on the skier's clothing and check the location and number of crests on the clothing. If any clothing or equipment checked does not conform to regulations, the skier must be warned that his/her clothing/equipment do not conform to regulations, and if the situation is not rectified before the race, it may result in the racer being disqualified from the competition.

Skis must conform to the current version of the FIS Specifications for Competition Equipment. This document sets out very detailed specifications that most, if not all, ski manufacturers follow to have their ski products deemed legal for racing. The specifications require that:

- Skis must have a minimum height of the height of the skier less 100 mm. To check this, have the skier stand on a board (a minimum of 50 cm (2 feet) square) so that neither the skier nor the skis sink into the snow.
- Poles must be no taller than the person's height for free technique events and no longer than 83% of the skiers height for classical events. (need a Pole Height apparatus)
- Poles must have a constant length (i.e. may not possess a telescopic system), preventing the ability to create a foreign energy to favour push-off (e.g. no springs or mechanical devices).

If any item is marginally outside the applicable regulations, the Chief of Start/Finish is consulted for a second opinion or the Technical Delegate is asked to rule on the situation.

Equipment markings should also be checked to ensure that they are in the same form as on products sold to the public.

Clothing Stewards Report to the Chief of Equipment Checking

Clothing Stewards are responsible for collecting and bagging the skiers' clothing prior to the race and returning it to the skier after the race. The clothing is put in storage where the area is secured (see above). The clothing is handed back to the skiers on request. While skiers are on course, the stored clothing must be supervised to ensure that it does not get wet or stolen.

Transponder Distributors Report to the Chief of Equipment Checking (N.B. This function may be assigned to the Start and Finish Chiefs in Timing.)

If a Competition Committee has decided to use transponders to monitor skier passage through control points, the transponders must be distributed prior to the race start. If the skiers are given their transponders prior to pre-race warmup there is no last-minute panic to pick them up and put them on. It

is imperative that the correct transponder is given to the skier to correspond with their bib number. The number of officials involved in distribution can vary greatly with the format of the race. Typically, this technology is only used with relatively-large fields of skiers so an adequate number of distributors must be assigned. At the end of the race, these same officials can put the transponders back on the racks in order and identify missing pieces as quickly as possible so that missing transponders can be tracked down before the skier leaves the race site.

Equipment:

- Transponder racks

Chief of Finish Line

Reports to the Chief of Stadium

Oversees the following:

- Finish Line Stewards
- Transponder Collectors

The Chief of Finish Line supervises the finish area and the Finish Line Stewards in maintaining a clear finish area once the skiers have finished the race and recovered sufficiently to move out of the area; and providing what is sometimes called "after care" for skiers needing support at the finish.

Procedure:

The maintenance of an organized and clear finish area is important for the integrity of the competition and safety of the skiers. Skiers must not be allowed to re-cross the finish line to warm down or visit a fellow skier. A patient support of the skier struggling to catch his/her breath, and in some cases recover, is what is required; but the skiers must be removed as soon as possible from the finish area for safety reasons.

Equipment:

- paper towels or facial tissue, blankets (on cold days and to keep prone skiers off of the snow), bib box, garbage container

Finish Line Stewards

Report to the Chief of Finish Line

Finish Line Stewards are responsible for removing the bibs from the finishing skiers; offering / providing support to exhausted skiers; and ushering skiers out of the finish area toward the clothing and refreshment area. Stewards may be asked to assist with removing the racers' skis.

Equipment:

- See Chief of Finish Line

Procedure:

The main concern is to move the skiers away from the finish line and toward the refreshment area where their bibs are collected, and where their clothing and equipment are located. When conditions are such that skiers may be subject to frost bite, hypothermia or exhaustion, medical aid and blankets should be readily available adjacent to the finish area. Skiers who collapse should be left for a moment to catch their breath (but not long enough that their torsos cool down on the snow), then aided to their feet to have skis removed. Provide facial tissues or paper towels to skiers who wish to wipe their nose and face.

In competitions where bibs are to be collected at the finish, it is sometimes a chore to obtain the bib from a very exhausted competitor. They are very willing to return the bib, but it can be a chore to remove it if they still have their poles on and a drink or two in their hands. When you ask for the bib, offer to hold, and reach out for, anything that they have in their hands, especially their poles, and let them remove the bib. Hand back the poles and drink while obtaining the bib.

*Transponder Collectors**Report to the Chief of Finish Line*

Working in concert with the Finish Line Stewards, the Transponder Collectors take transponders from skiers as soon as possible and check off the transponder numbers that have been retrieved on a start list. The transponders should be placed in bins and taken to the racks. The Transponder Distributors can then replace the pieces on the racks and quickly identify and seek out any that are missing.

Equipment:

- Bin to collect transponders

Chief of Feed Stations*Reports to the Chief of Stadium*

Oversees the following:

- Drink Pourers
- Servers – on course and in finish area

The Chief of Feed Stations is responsible for the operation of the stadium refreshment station and any others on the courses. Since many races do not require a refreshment/feeding station on course because of the shorter course distances, this position reports to the Chief of Stadium. The Chief may assign a person to look after the on-course refreshment stations if there are any, but the supplies are generally the same at any station.

It is very Important that, prior to the competition, the Chief of Feed Stations research any sport drinks that might be served to ensure that they do not contain any banned substances that might be caught during doping control. At high-level events, athletes prefer sealed bottled drinks to ensure the absence of banned substances. The drinks that are going to be served should be announced at the Team Captains' meetings so that the athletes can be advised beforehand what to expect.

Procedure:**In Stadium:**

- organize provisions and equipment for both stadium and on-course stations;
- have a refreshment station in the stadium to provide racers with replacement fluids as well as to offer hospitality and fun for young racers at every competition;
- purchase and transport provisions to the race site in sufficient quantity for the number of entrants, (this will vary with the length of race and the air temperature. i.e.: cold day: more warm drinks etc.);
- make a ready supply of water available (if the water must be transported from off site, be sure to bring some hot water from a main supply source to reduce or eliminate heating water on site. It is easier to cool water down than it is to heat up);
- offer a minimum selection of two drinks: plain water and an electrolytic replacement product. (if electrolytic replacements are not available, juice-type drinks such as apple, peach, or orange juice mixed with water and served as a diluted solution may be used);
- serve drinks in environmentally-friendly or reusable bright plastic containers if possible, for both cold and warm 21° - 27°C (70° - 80°F) options;
- store drinks in large, insulated jugs and pour into cups as needed; and
- consider providing orange slices or other fruit.

On Course:

- Position a refreshment station every seven or so kilometres (ideally, plus one in the stadium); ensuring they conform to guidelines for refreshment stations (See Section 9 Stadium Layouts – Other Areas regarding Feed Stations).
- Store the liquids in the insulated jugs or keep them warm in pots over gas burners. As skiers begin to appear, two people pour the cups/containers 1/2 full while three or four servers offer drinks at various points along the track at the station.
- Serve beverages in brightly-coloured, environmentally-friendly, containers (ideally) such as plastic cups or bottles, at a recommended temperature of between 21°C - 27°C (70°F - 80°F), i.e. lukewarm.
- Call out the kinds of drink being offered to the skier to determine which drink they desire as they enter the refreshment area (i.e. water or juice). It is the skiers responsibility to state a preference.
- Have servers practice under simulated on-snow conditions; and warn them to be prepared to get covered with spilled juice and to dress accordingly.

Equipment:

- Large 20-litre insulated jugs, environmentally-friendly or reusable drink cups (preferred), table(s), garbage bags, large containers for cut oranges, muffins etc., paper towels, tissues, water, juice, and/or bottled drinks with complete product labeling, and returnable-bottle containers if offering bottled drinks.

Drink Pourers

Report to the Chief of Refreshment Stations

Drink Pourers are responsible for keeping the servers supplied with sufficient feeding containers (bottles or cups) to serve competitors arriving at the feeding station.

Procedure for pouring drinks:

Drinks must be served at the correct temperature. In cold weather, don't fill the feeding containers too far in advance of the skier's arrival. If the drinks get cold, either dump them out or return them to the large thermal jug. It is best to start out with liquid a little too warm as it can always be cooled. Feeding containers should be half-filled to avoid spillage by fast-moving skiers.

Servers – On Course

Report to the Chief of Refreshment Stations

Servers deliver drinks to moving skiers so that they are able to maintain a reasonable speed as they pass through the refreshment station. The regulations require that servers be still when serving in mass-start races.

Procedure:

It is important for a skier to take fluids during a long race. Missing a "feed" can seriously disadvantage a skier, especially in warm conditions. Servers must be able to move quickly and with good balance in order to efficiently deliver the drink container to a fast-moving skier. Practice is required. Servers should be positioned along the track as described in Stadium Preparation. This spacing avoids skier pile-up and provides a last chance to serve a skier who has missed their feed.

Procedure for serving skiers:

For Interval-start races the server may run to try and match the speed of the skier. For Mass-start races they must remain still. Mass-start races feature large groups of skiers so remaining still avoids collisions among servers.

Servers – Finish Area

Report to the Chief of Refreshment Stations

Servers in the finish area often bring drinks to the finishing skiers. Sometimes, these skiers seem to be unable to catch their breath. As quickly as possible, try to give these people a drink of a warm liquid, which seems to open the throat passage and assist breathing. Let them sip it slowly until their problem is over. In many cases, skiers will want more than one drink, so there should be plenty of fluids on hand.

Procedure:

- mix warm and cold drinks in appropriate quantities and put in insulated jugs;
- slice oranges, other fruit, and put muffins or cookies on trays for serving;
- transport supplies to refreshment area and set up;
- serve drinks and food to skiers as they finish; and
- clean up after race finishes.

Chief of Relay Exchange Zone

Reports to the Chief of Stadium

Oversees the following:

- Exchange Zone Pre-Caller
- Exchange Zone Controllers
- Exchange Zone Judge

Duties:

- ensure that the zone for relay exchanges is the proper size according to the rules and that it has been groomed and track set correctly;
- ensure that the start and finish lines of the exchange zones have been marked;
- ensure that the zone is sufficiently fenced to both allow skiers to enter and exit the zone before and after being tagged; and
- ensure that sufficient officials are trained and available to handle the amount of activity expected.

During the competition, this Chief must supervise the various functions to ensure that they are being correctly handled.

According to the regulations, the exchange is achieved by the arriving competitor, with a tap of the hand on any part of the next competitor's body while both competitors are in the relay exchange zone. Note that tagging with the ski pole is not considered to be an exchange tag. If the exchange contravenes the regulations, the incident must be recorded, and the Jury informed. The Jury may apply a sanction.

For Skiathlon ski exchanges the Chief must make sure the Controllers monitor the 'pits' to ensure skis are kept within the pits and not released loose onto the course.

Exchange Zone Pre-Caller

Reports to the Chief of Exchange Zone

The Exchange Zone Pre-Caller calls out the bib numbers of the approaching skiers to help the next competitors to move into the exchange zone to accept the tag.

Exchange Zone Controller

Reports to the Chief of Exchange Zone

Exchange Zone Controllers help to organize the waiting team member of each relay team, ensuring that they do not enter the exchange zone until their currently-skiing team member can be seen to be approaching the exchange zone. Waiting relay members can identify their team members as they are approaching the exchange zone, and they often move in at that time. Team members entering the exchange zone to await the tag must not interfere in any way with other skiers entering the exchange zone. After the tag is made, the finishing team members must "stay the course" (i.e. must not move across in front of another competing team member, thus interfering with that person), until it is safe to move to the side of the exchange zone or course. The controllers should also ensure that finishing team members exit the exchange zone.

Procedure:

To eliminate congestion in and around the exchange zone, try to ensure that only the next team competitors are waiting near the entrance to the exchange zone, and that teams do not enter the zone unless their team members can be seen to be arriving momentarily. Ensure that finishing team members exit the exchange zone or course without interfering with other competitors; and that they are not near the entrance to the exchange zone.

*Exchange Zone Judge**Reports to the Chief of Exchange Zone*

The Exchange Zone Judge ensures that a proper tag is made on the next skier. The tag must be made by the incoming skier's hand; it must be made on the body of the outgoing skier (there is no definition of body, so any part, such as a hand, back, head, bottom, leg, etc. is legitimate); and it must not be made so vigorously so as to constitute pushing the starting competitor (the rule states that "any way of pushing the starting competitor is forbidden"). A tag on the next skier's ski pole or ski is not considered a legal tag. Because the exchange zone is quite large, it is suggested that there be four judges, two on each side, spaced along the zone. This way, it is possible for judging to take place anywhere along the zone. Should a legal tag not take place before the next competitor exits the exchange zone, a judge must record the fact and report it to the Jury as soon as possible.

Procedure – Relays:

Spread the judges along each side of the exchange zone, ensuring that the whole zone is covered by a judge. When a tag is legally made, the judge should signal such, usually by raising his/her hand in the air and pointing to the team member.

Procedure – Skiathlon:

For skiathlon ski changes, the skis and poles must be kept within the 'pit' box and not loose on the course. If a piece of equipment does stray onto the course, record it to be reported to the Jury and retrieve the equipment while making sure not to interfere with any skier.

SECTION 11: COMPETITION SECRETARIAT

Introduction

The Competition Secretary (CS) and the Race Office team are key to a successful event at any level. They must be identified early in the event planning, given all the human and technical resources possible, and in the case of the CS, be involved in all possible pre-event meetings. The role of the CS can often be extended at smaller events to include financial responsibility as well as general administrative activity beyond his/her core task. (A word of caution here: a good Chief of Competition makes sure that the tasks likely to distract the Secretary from the core responsibilities are allocated elsewhere.)

More than for any other position, except perhaps for the Chief of Competition, the art of delegation by the CS is a mandatory talent. There are too many tasks in this function to be done by one person, so delegating many of them to other competent volunteers must be done. For example, the CS cannot be in the race office, at the Team Captains' meeting, sorting bibs, collecting money, etc. all at the same time. Therefore, the CS must delegate some of the tasks to others. The art of delegation is not one of simply passing certain duties to people and never having to worry about them again. It is assigning certain duties to others, giving them guidelines under which to perform the functions, checking with these people from time to time to answer any questions that may have arisen, ensuring that progress is being made on the tasks, showing support for the staff, obtaining information from them to solve certain problems that have some priority, etc. By delegating, the CS can accomplish, in a short period of time, a span of tasks that would be impossible to do by oneself and that will ensure the success of the event.

The art of saying no must also be in the Competition Secretariat's toolbox. Since they know instinctively what is going on at the event, it is very easy for others to assume that the Competition Secretariat will handle any gaps in planning. This should not be the case. For example, the scheduling and giving of prizes is clearly outside the mandate of the Competition Secretariat, but easily ends up on their desk.

The responsibilities of the Competition Secretariat include (but are not limited to): creating the Race Notice, creating the registration process and forms for online registration, answering registration questions, collecting and disseminating appropriate race-related information, attending and taking minutes of Team Captains' meetings, providing accurate data on the competitors to the Chief of Timekeeping and Data Processing, preparing the start lists. In concert with Timekeeping & Data Processing, the Competition Secretariat is responsible for publishing interim results and official results online as well as posting the hard copies to the official notice boards.

While the Race Notice and web site may list local accommodation during the event, the CS should play no part in arranging accommodation for coaches and competitors. This is squarely in the area of an Athlete Services Chair or is done by the team captains themselves. Responsibility for accommodation for the TD and ATD will fall to either the CS or the Organizing Committee.

Within some Competition Committees, the expertise for creating start lists is with the Timekeeping, Scoring and Data Processing team and is an excellent example of appropriate delegation. In this section, additional tasks and responsibilities will be identified as will the potential for their being delegated to others in the organization.

General Description of Responsibilities

Where possible this description will be chronological and refer to the performance of a team led by the CS. More details of the duties of individual officials may be found in [Section 12 – Competition Secretariat Officials](#). Some parts of this section are requirements by regulation like Team Declarations, Start List preparation etc. Others are recommendations of processes that are known to work for large events like National Championships. In choosing which recommendations to follow and which to ignore, consideration must be given to the level of the event and the size of the entry Appendix 4 is a key resource.

Pre-event Planning and Communication

In attending all pre-event planning meetings of the Competition Committee, the CS will become familiar with the rules and guidelines under which the event will be run. This information takes the form of Regulations (including any specific rules for Canadian multi-category situations); a Technical Package which sets out specific details concerning the race, including the eligibility of competitors; and the Officials' Manual. All of this information must be reviewed to become aware of any specific situations or processes that are particular to the CS's responsibilities. A Race Notice must be assembled and approved by the Chief of Competition and the Technical Delegate. The Race Notice is typically set up as a downloadable item on National and Divisional Event Calendars. It should also be posted to the event web site. The essential contents of a Race Notice and web site are shown in [Appendix 4](#). The Competition Secretary must ensure that any fees required by FIS, Nordiq Canada or a Division to sanction the race are submitted.

The web site containing the information on the Race Notice should be available at least two months in advance of the race. The registration system, now generally done online, must be tested to ensure that it works properly, and that all the information is correct. Race-event web sites are becoming the norm for providing information on the event, its sponsors, accommodation, vehicle rental, meetings dates and times, entry fees, late entry fees, etc. Experience is showing that racers typically register within the last week preceding the event, when they are confident of their state of health and fitness and in the impending weather. However, an "Early Bird" fee discount may encourage earlier registration.

The CS needs to arrange suitable locations for a competition office, team captains' meetings, etc. Once the office and meeting rooms have been decided upon, it is necessary to arrange for the other equipment to be obtained for the office, such as telephones, high speed photocopier with collating ability, internet access, tables, mailboxes for the teams at more formal events, etc. While most of this can be rented, it may be possible to obtain equipment from specific companies and then to "pay" for them by offering to make them sponsors, thus giving them a marketing opportunity. All of this must be arranged well in advance of the event to ensure that it will be in place in time.

With the assistance of the Chief of Competition, the CS should ask that each Chief submit a request for lists and forms they will require, so that enough copies can be prepared/printed. This cannot be done until registration is closed and the number of competitors, the format of the race, the courses and general schedule are known. The CS will have 'masters' of each form that can be reproduced on the appropriate (and different) coloured paper for each day. This is a job that should not be left to race day, and it can and should be delegated to a specific Race Office Assistant. A sample form for Clipboard/Form requirements can be found at [Appendix 4](#).

Accepting and Checking Entries

This task has been made simpler and faster through the use of electronic communications and online race management systems (RMS). Registration is done by athletes or team captains using an RMS. The system will confirm receipt of the registration and the CS should set up a publicly-available online confirmation list so that entries can be confirmed, and athletes/coaches can review who else is registered. The CS will use e-mail extensively to communicate with athletes who have errors or omissions so that registrations can be corrected PRIOR to the beginning of the event. For major events, this must be done throughout the registration period as there is not enough time after the registration deadline to get everything communicated and corrected.

The CS must ensure that skiers are registered in the correct category. In general, skiers younger than those in the senior category (U16 and U18) may “ski up” in an older-aged category up to the senior level; while masters skiers (older than Senior skiers) may “ski down” in the senior category. *If an entry is sent in showing a skier either skiing up or down a category, an email/telephone call to the competitor or coach is a good idea, just to confirm the data.* This “skiing up” situation has caused coaches and team managers to forget about checking skiers registered in higher categories. The gender input into the registration should also be checked and confirmed ahead of time if there is any doubt. A final check of all skiers registered is done at the first Team Captains’ meeting

In most cases the CS will be directly responsible for the collection and accounting of entry fees (and any applicable day licenses) whether paid by cash, cheque or online credit transaction. It is appropriate for the Secretary to collect fees for banquet tickets, event memorabilia such as T-shirts. However, all other activities related to the banquet and distribution of event memorabilia must be delegated to someone outside the competition office. This falls under Athlete Services.

Finally, it is important that skiers have signed a Waiver of Liability of the organizers, absolving the race officials, its sponsors, and suppliers of any liability should a competitor decide to sue for negligence or any other reason. Holders of Nordiq Canada Race Licenses have already done so as a part of the license application. Signing an electronic waiver is also part of a complete online registration system. Remember: NO WAIVER, NO FEE, NO RACE!

Late Entries

Whether or not late entries will be accepted should be decided by the time of issuing the Race Notice, and wording to this effect should be in it. They must be handled in accordance with the Technical Package (if there is one). If there is no Technical Package, then it will be at the discretion of the Event Organizing Committee. The value of putting every submitted entry onto a web site for review/verification is considerable in identifying missed entries. If late entries are permitted, the fees (if additional) must be clearly indicated on the entry process. The Competition Committee, Jury and the CS must be equally clear on how late entries will be treated on the day of the competition since a start list will have been produced the night before. Gaps left in bib sequences and start times between categories could be considered to allow for late additions. The late entry should not be given any special consideration/advantage unless the race organizer is at fault. That is to say, they forfeit the right to seeding.

Pre-event On-site Activities

The operation of a race office prior to an event is usually guided by the Technical Package. For National Championships, the office should be open two days before the first competition, but for a Division Cup the previous afternoon may be enough. For a club race, a very early morning start may suffice. Either the CS or Office Manager must be available at all times that the race office is open.

As soon as the race office opens, clearly post a list of registered competitors complete with their category, club, and respective points ([See Appendix 4](#)) as well as a schedule of events. This schedule should include the time and location of any meetings and the required time for any submissions such as seeding submissions, relay team declarations, medical forms, protest forms, etc.

As team managers, coaches and athletes arrive for the event, encourage them to check race entries and schedules. If a change is being requested by an athlete or coach make sure a record is kept of the change, the name of the person making the request, and verification that they represent the athlete: i.e. they are from the correct club or division. Have the requestor print his/her name and sign the change form. Other duties might include signing out wax-room keys to team captains and service personnel, and troubleshooting other team requirements, etc.

Team Captains' Meeting

Team Captains' meetings are held a day or so prior to a competition and usually the day before each race during a multi-day event. They are not technically open to the public, but only to the team captains (usually the coaches) and major officials who will be making presentations; they are not reunions for long-lost coaches or acquaintances, nor is it a party! However, in practice (particularly for low-level competitions), other interested parties are often allowed to attend, but only in an observer capacity – only the team captains have the right to speak or ask questions. Proper decorum must be expected by all, and observers should be reminded that talking in the meeting room while the meeting is in progress is not allowed. As such, the chairperson, usually the Chief of Competition, should establish those who are in attendance as team captains, ensure that their names and teams are recorded in the minutes, and ensure that only these official representatives speak and ask questions. This is best achieved by circulating a sign in sheet. Dealing just with team captains simplifies a great deal how many people the CS must deal with on administrative matters – dealing with all coaches can be a very time-consuming process!

Seating the team captains at the front of the room can help establish their authority and allow closer contact between the officials and the captains during the meeting. Each team is allowed two people at a table, the position of which is assigned by signs in alphabetical order. At high-level events, it is the custom to have flags and/or name tags on the team tables for each team represented. Only one person can speak on behalf of a team, and the CS should know who that person is at the start of the meeting.

The meetings are called to order and chaired by the Chief of Competition to review detailed pertinent information with the team captains. All major officials should be in attendance. These meetings are normally followed by creation of start lists. These meetings must start on time. This sets the tone for the whole event – that the organizers and officials are on time, business-like, ready, competent, and know their business. *Don't lose this opportunity to set the tone!* Coaches or team captains who are late will then know not to be late for the next meetings.

Make sure that all equipment is set up in advance, and that it works, particularly the overhead projector and any computer projector. Remember also that coaches would really like to be with their athletes helping to wax skis and doing the final coaching tasks, rather than being in a meeting that doesn't start on time, drags along, and ends much too late.

The chairperson must ensure that the meeting moves along smartly; not allow large gaps of silent time to occur during or between topics; cover the material concisely and clearly; and ask for questions (but not wait too long because this will encourage "stupid" questions just to break the silence – let them interrupt if they have a question). The Chief of Course should not drag out every bend, hill and valley on the course, but only cover the particularly-hard ones, etc. The Chief of Stadium should have the stadium layout diagram quite accurate as to the relative location of the various stadium areas and explain the coming and going of the competitors quickly but clearly. Apologies should not be necessary, as the situation that requires the apology should have been fixed before the event started. Again, how this aspect is handled will set the tone for how coaches will think about the competency of the officials in the performance of their duties. Athletes and coaches come to an event expecting good quality courses, stadium and timing, and the performance of officials during the Team Captains' meetings will solidify their belief (and hope) that the officials are competent. Post the presentations to the event website after the meeting, ensuring critical changes such as start times and start order have been made.

Put all parts of the presentation (likely Microsoft PowerPoint) in one file on one computer.

The following list shows the main participants and the topics for which they are responsible. A detailed agenda is shown in [Appendix 4](#):

- Competition Secretary (CS) – roll call of teams (coaches) – can be by circulation of a sign in sheet. (Provide the clip board and pen!)
- Competition Secretary – distributes confirmation list of entries to accept corrections before Start Lists are prepared.
- Chief of Competition (CoComp) – introductions: Technical Delegate, Major Officials, Team Captains or Coaches.
- Chief of Competition – congratulations to winners if this is at the end of a race day.
- Technical Delegate – review any new rules or recent rule changes. Also, may want to emphasize a particular rule depending on the next day's technique, e.g., position of technique zones for classical race.
- Technical Delegate – establish the Jury or make its pre-determined composition clear.
- Chief of Competition – weather report, including present day and forecast for race day temperatures, winds, relative humidity, atmospheric pressure with possible percentage of precipitation and amount expected. Correlate the regional weather forecast to the uniqueness of the race-site weather.
- Chief of Competition – review the start order of the race categories, and the course(s) to be skied (with the Chief of Course).
- Chief of Competition – set final category race order.
- Chief of Course (CoC) – review course(s) maps and conditions for the next day's race and point out any possible concerns, refreshment station(s), track setting procedure used, etc.
- Chief of Competition – start times, schedule, length of race(s), course closure times, stadium closure times, etc.
- Chief of Stadium (CoS)- review stadium area layout and support services in stadium area.

- Chief of Stadium – weather boards; where located, temperature taken when and where.
- Chief of Stadium – report on warm-up area or rules and wax testing area.
- Chief of Competition - explain when and where interim, unofficial and official results will be posted and the location of the Official Notice Board.
- Technical Delegate – protest proceedings.
- Chief of Course (CoC) – refreshment station and type of beverages served.
- Athlete Services (AS) – information on transportation.
- Competition Secretary – availability of start lists (where, when).
- Competition Secretary – identify time and place for distribution of bibs
- Chief of Competition – use of leg numbers, where they should be applied to the body and their distribution.
- Chief of Competition – use of transponders, where they should be applied to the body and their distribution.
- Chief of Competition – charge for race bibs not returned.
- Chief of Competition – Award Ceremony details.
- Competition Secretary – times and place of subsequent meetings.

Preparation of Start Lists - The Draw and Seeding Process

The draw for start positions is normally conducted following, or during, a Team Captains' meeting. It falls under the responsibility of the Competition Secretary but is often carried out by Timing personnel. The Technical Delegate or his/her appointed jury member must be in attendance to ensure that the procedures are fair, accurate, and in accordance with the rules governing the competition. The draw process serves two purposes: it attempts to ensure skiers start close to others of equal ability; and it assures that no one team enjoys an advantage over others with respect to the starting order of competitors in their category. Therefore, the draw process must be absolutely fair and in accordance with the Regulations and the Technical Package guidelines.

Establishing the order of start within a category

Interval-Start Races

It is normal that the faster skiers are placed later in the start order by "Grouping" (see below). This is done with the expectation that the course will become quicker as more skiers pass over it. In the event that it is likely the course will quickly deteriorate (e.g. quickly rising temperature), the Jury may change the order of start where the group with faster skiers may leave first.

Mass-Start Races

For this format it is better for the faster skiers to be at the front where they will be impeded less. If points are available (e.g. Canada Points) they can be used to have the skiers start in points order. If there are no points, a mass-start race could/should be run after an interval-start race and the skiers started in their order of finish from the first race.

Sprint Qualifying

It is best to start the fastest first to reduce overtaking and ensure the individual gets a clear course to make the best time. In addition, it can provide the excitement of knowing the time to beat to get into the Sprint Heats after the first 30 skiers have finished.

The creation of start lists differs significantly depending on the level and format of the competition and should be described in the Technical Package if there is one. Otherwise it will be done according to the Rules and Regulations.

The preferred order of start varies with the type of race being run and, in some cases the condition of the course. However, for example, in the sprint qualification race, it is best if the course can be forerun by a number of forerunners. Alternatively, if for the first category starting, the slower skiers can be sent out first followed by the faster ones, the course would be better packed for the following skiers and a well-packed course usually skis faster.

Verification of Entries

The verification of entries should be done before the Team Captains' meeting, ideally as soon as the team arrives at the race site before the competition starts. If it has not been done and this phase of the meeting is necessary, the CS will confirm the number of skiers and their names to be entered in each race with each team captain. When a registration deadline has been set, it serves to allow the CS to finalize any input to the RMS, and then to confirm that all the athletes names and categories are correct; if the registration system is closed very close to the race, it does not allow sufficient time to verify the competitors' lists. The CS can speed the verification process up by posting a list of entries by team and asking the Team Captains to verify their athlete entries and sign off on this a few hours before the first Team Captains' Meeting. If the race is a small and informal one, without a Technical Package, there may be changes and additions to the list of athletes, particularly if late registration is permitted; the later the close of registrations, the more chance there is of errors, and the less chance there is of doing proper verification of the entries. It is strongly suggested that registrations be closed a few days prior to the start of an event to allow the CS to finish the data validation and to produce lists to be verified before or at the first Team Captains' meeting.

Entries for Team Events

At National Championships and many Division Cups, team events are run (either team sprints with two skiers or distance relays with three or four skiers). While the skiers may have indicated in online registration that they are to participate, the make-up of teams and skier order are not usually determined ahead of time. Typically Relay Declarations must be submitted to the Race Office by the middle of the day preceding the race(s). See [Appendix 4](#) for sample forms. The team members and race order are declared and used to create start lists. Substitutions and changes of team order may be made up to two hours before the race.

Grouping

The procedure of grouping is designed to ensure that for interval-start races, skiers in a category will be starting in close proximity to other skiers of equal ability. This procedure splits the entire field of skiers into groups. The number of groups is determined strictly by the number of participants entered in the category.

FIS/Nordiq Canada Rules provide the following details as to numbers of participants in each Group.

20 or fewer	2 Groups
21-40	3 Groups
Over 40	4 Groups

The starting order is normally Group 1, 2, 3, 4 and groups are drawn in that order. In special circumstances, the Jury may change the start order. For example, with an interval start if it is expected that the race conditions will deteriorate quickly as the day wears on so getting the best skiers out first gives them the course at its best time.

If the Technical Package specifies that grouping will be done by a points list, this simplifies the process significantly. FIS points show the best skier having the lowest number of points, with the number of points increasing for each slower skier; Canadian points lists show the best skier having the highest number of points, with subsequently slower skiers having fewer points. Many Technical Packages require that a "Seeding Points List" be secured from Nordiq Canada immediately prior to the events. Be careful - there is a points list for distance results and one for sprint events – make sure that you obtain and use the correct list! These lists are updated up to five times during the competition season and at the end of the season, so it is important to have an up-to-date version of the lists when running an event.

Normally the race management software will handle seeding by points. It does so by first establishing the number of groups required from the number of entries in the category (e.g. 35 skiers will divide into three groups), and then allocating the skiers to groups done in ascending order of points (CPL) or descending order of points (FIS) (e.g. Group 1 will have 11 skiers, Groups 2 and 3 will have 12 skiers each). If seeding by points is not used, the CS must provide each team captain with lists of the team's skiers and indicate the number of groups per category that there will be.

Draw by Points

The Technical Package for the race must specify that the draw will be done using a specific points list as of a specific date. For Interval-start races, skiers are placed into groups according to their points standing provided by Nordiq Canada or FIS. Skiers with a license but without points are placed in a separate group. (These are usually skiers who are just getting into competitive skiing and have not raced for points yet.) To make the draw work properly in an electronic system, they must be given 1 point and skiers with no license .1 points. New license holders will then get preference over non-license holders.

Mass Start in Points Order

The Technical Package for many events (e.g. Canadian Nationals) will specify that categories will not be drawn. Rather, they will start in CPL points order, i.e. skier with the highest points standing (the best skier) will start in position 1, the second-best skier will start in position 2, and so on. This method lends itself to benefiting from the chevron start layout and it should be used. The start order will not be randomized within groups except in the case of those who have no points - they will be grouped and drawn.

Sprint Qualifications in Points Order

For Sprint Qualification, no draw takes place and skiers are started in the order of points they hold. It is essential that the seeding here sends the fastest skiers out ahead of slower ones so that there is minimal chance of overtaking. (See qualifying remarks above under “Establishing the order of start within a category”.)

Relay Draw

The draw procedure for relay team events is designed to assign start lanes for the teams, rather than for the individuals. The Team Captain is responsible for submitting the relay team lists to the CS before the draw. The latest time for submission should be stated in the Technical Package, in the Race Notice, in the Event Schedule, and posted in the Race Office. The rules give complete details regarding late entries, reserves, and team order. These details should be explained to the Team Captains in either the event Technical Package or at a Team Captains’ meeting. The CS should initial and time stamp relay declarations both when first submitted and when the final order of competitors is submitted. This should avoid any potential for protests concerning the timing of submissions. Team start positions are determined by either a previous set of results (i.e. team standings at the previous year’s championships), or by a prescribed draw procedure. Details should be clearly stated in the race Technical Package.

Pursuit-Start Race

The pursuit-start race is the second race of a two-race competition whereby the competitors have their start order and start times determined by their placing and finish time in the first race. ([Appendix 9](#)). However, the start order of the race categories and the start times (time of day) need to be decided before bib allocation. Usually, the Chief of Competition and the Technical Delegate, along with the Chief of Course, will consult and decide the start order to minimize merging skiers, lapping skiers, congestion on the course, and so on. Often, time gaps are left between categories to allow the course to be cleared of the last category before the next one starts.

Bib Allocation

Bibs for all races are normally allocated in the order that each person starts his/her race. This, of course, is usually determined through a draw, or through the use of the points lists. There need not be any gaps left in the bib numbers between categories, but there may be circumstances that would make it prudent to do so. Allocation of specific bib-number ranges to different categories in a race needs to be made in consultation with the Chief of Competition, Chief of Course, and Chief of Timekeeping, Scoring and Data Processing. First, a complete continuous bib set is essential (i.e. there must be no missing bibs) – an incomplete set of bibs is of little use. Then, if it is decided that some bib numbers should be left between categories to accommodate late-registering skiers, this can be done.

If intervals of time are left between the start times of categories, then it may be desirable to start the next category with a bib number ending in the digit “1”, e.g. 51, to help organize the start, although there is nothing wrong with leaving a few bib numbers out and then picking up the next one, whatever it might be. However, since there is an unwritten convention that even-numbered bibs should correspond to start times on an exact minute and odd-numbered bibs should correspond to a start time 30 seconds after any minute, then the next bib should relate to its corresponding time. When using 15-second starts, even bibs are allocated to starts at 30 seconds and on the minute; while odd bibs apply to 15- and 45-

second start times. For mass-start races using a chevron, each category needs to start with bib #1 as this makes loading the start grid much easier.

If a multi-coloured bib set is used, it can help course controllers identify the race categories of skiers passing them. For example, if certain coloured bibs (e.g. red) are used for those racers skiing on course “A”, and a second coloured set of bibs (e.g. green) are used on course “B”, the controllers can verify their results more easily.

With the plan for bib allocation in hand, along with the intervals between starts of categories, the CS can have the computer operator create the start list. The first printed copy should be checked by the TD and Chief of Competition, and then, once approved, enough copies for the officials need to be made. Place it on the web site as soon as possible. The “race” is now official, so the correct file backup must now be passed to Timekeeping to score the race. Copy the race file onto a USB Thumb Drive. Even if only one computer is being used to run the race, there must be a backup computer available in the event of a failure. As a general recommendation the file should be proactively named with a date and time (example Nationals20190302-1710). Relying on identifying the correct version of a single filename by operating system timestamp is somewhat risky.

For elimination sprints, it is essential to have two sets of bibs. The first set is used for the qualification round, and second for the heats elimination round. It is much easier for the skiers and starters if the bibs reflect the ranks attained in the qualifying round: e.g. qualifiers in the first category have bibs 1-30 and in the next 31-60 and so on. In this way, the numbers reflect the finish order of the qualifying round and help in knowing the order of lane selection for each of the heats. It is essential that CLEAN bibs be provided for Sprint Heats so hosting a sprint race means you must have enough bibs to do this.

For relay races it is desirable to have a set of special Relay Bibs i.e. 4 bibs each with a large number and a smaller number indicating the leg in the relay race. Relay bib sets are conventionally coloured for each leg, the order being Red, Green, Yellow, Blue. For Team Sprints only the Red and Green bibs are used. However, as relay events are not commonly held, a Relay Bib set may not be available. Regular bibs can be used in sets to include the relay leg and team number. In such a case, Team 1 could be assigned bibs 11, 21, 31, 41 etc. and Team 2 given 12, 22, 32, 42 etc. (limiting the race to 9 teams); or Team 1 gets 101, 201, 301, 401 and Team 2 gets 102, 202, 302, 402 etc. (but not all teams have 500 bibs!)

Bib Picking for Distribution – All Formats

The best way to pick bibs depends on the size and type of race event. For race events with less 100 athletes, giving out bibs individually is a viable option. For these race events, the start list is usually produced the morning of the race. Bibs are placed in groups of 10, and four volunteers hand out the bibs to each athlete. Ask the athletes to create two lines. Each line has two volunteers. The first asks the athlete for his/her name and category. This volunteer communicates to the bib-pick volunteer who then finds and hands the bib to the athlete. In this type of bib pick up it is important to have a start order with category start times, or a start list, near the bib pick up table. When athletes ask for their start time the volunteers can direct them to that list. Volunteers should not give out start times, particularly when other athletes are waiting to pick up their bibs. This just slows down the process. For larger events there needs to be a different process. Having to contend with issuing 500 bibs individually the morning of a race is too big a job to be feasible; try to group the bibs and issue them by groups.

Bib Picking – Mass Start, Interval Start, Sprint Qualifier

(see later for Relays and Sprint Heats)

Once the start list has been finalized, the process of picking the bibs for distribution can begin. There are several methods to do this efficiently. Two sample are documented here. You can then choose based on available space and volunteers. N.B. It is recommended that reusable (rather than single use plastic) bags be used. Be sure to ask for these bags to be returned to the race office for reuse. (A label on the bag will help but it is suggested that a race office helper do a sweep of the venue later in the day to collect those that haven't been returned yet.)

Method 1

- The registration form must allow the athlete to choose to have their bib in a club, team or individual pick up bag.
- Prepare a version of the start list that groups the bibs by the field mentioned above and sorts within the group by bib number.
- Print two copies - one for reference, the other to put in the bag with the bibs. The choice is to cut up a big list or print one page per group.
- Find sufficient space so that bibs can be laid out in piles of 10 (300 bibs in piles of 10 will need at least 7.5 square metres of table space or 15 metres of linear bench space).
- Operating in teams of two, one person calls the bib number and the second picks it from the pile and places it on the first person's arm.
- When the whole list for a team has been picked, the pile must be double-checked, piled neatly in bib order number and placed in a bag. Have one bib picker initial the race-office copy of the start list once the contents are verified correct.
- Put a copy of the list in the bag.
- Add a Start List to each bag of five or more bibs. Teams of 20 or more should get two Start Lists.
- Staple a label to the bag (this can be done ahead of time) with the team/club/school name.
- Place the bags in alphabetical order behind the tables which will be used for bib pickup on race day.
- On race day, the name of the person picking up each bib bag is printed on the bib bag label and the label is removed from the bag and kept for reference in a case where someone else comes for that bag.
- Have the person picking up for the team verify that the contents of the bag match the start list and initial the race-office copy. This considerably reduces the number of complaints that a team did not get a bib.
- Bibs for individual racers should be in bib number order on the table. (If you wish, you can label them with the racers name and sort alphabetically by last name instead. This usually applies to Masters skiers who have a club but do not wax and train with the club.)

Method 2

If space is very limited and the competitors represent a small number of teams (fewer than 10), there is an alternative which would require about five linear metres of bench space for the sorted piles and less than five square metres to lay out the bibs to be pulled.

- Make a sign with the team name above a bench or table.
- Lay out the bibs in a few piles in numerical order.
- One person has the regular start list and calls out the bib number and the bag to which it belongs.
- The rest of the pickers will, in turn, take the bib called and put it in the right bag.
- If the “caller” sees two in a row from the same club, it is OK to call both.
- Once the calling has finished, a team of two will do the double-check using the same list as described above (grouped by club/team/school, in bib number order).
- When all the bags are ready, add the start list.
- Clubs of 20 or more should be given two copies.
- Pile unused bibs (because gaps have been built into the start list) and mark them “clean” so that they aren’t sent for laundering.
- Keep them handy in case there is a misplaced bib on race day.
- One of them can be renumbered using duct tape and a black marker. (Be sure to remove the tape before sending to be laundered.)

Method 3

For race events with more than 100 athletes and one or more teams there is another method. Prior to arriving at the bib sort, the CS will have prepared a “bib-sort kit”. This kit includes “bib-sort sheets”: one sheet per club/team with the team/club name (from the bib sort field) in big letters; a series of stickers with each club/team name for each bib bag; pens; as well as large stickers (leg stickers work well) for leader bibs and a Sharpie (if leader bibs are being used). Armed with the bib pick list from the RMS, and the “bib-sort kit”, the CS’s team can pick the bibs and bag them by team or club.

- Find sufficient space and lay out the “bib-sort sheets” on the floor, in a circle, in alphabetical order.
- With the bibs in the middle of the circle and working with at least two people (the more people you have the faster this goes, four is ideal), bib caller hands out the first number and calls the team/club name from the list. (For example: “#1, Nakkertok; #2, AWCA; #3, CNEP etc.).
- The second person (and other helpers) takes the bib from the caller and places it on the appropriate “bib sort sheet” on the floor and returns to the middle to get the next bib.
- Once all the bibs have been distributed, place the “club/team group” sheet on each pile and cross check that the pile includes all of the bibs for that club/team.
- Once the cross check is complete and any errors are corrected, the bibs can be placed in the appropriate bag with the team/club label attached to it.
- Include the “club/team group list” in the bag.
- If using “Leader Bibs”, prior to placing the bibs in the bag, follow this procedure. Using a Sharpie and a leg sticker write the leader’s bib number on the sticker in big, legible writing.

- Place the sticker on the leader bib. Replace the bib with the leader bib, then close the bag.

Club/Team Bib Sort

Alternately, a bib sign-out sheet can be used.

- Each team prints and signs their name on the sign out sheet.
- Before removing the bib bag label, or signing the sheet, ask the person picking up the bibs to check that all of the bibs on the list are in the bag, and that all of the bibs that should be in the bag are in the bag. Have them initial the race office copy of the list to considerably reduce being blamed for missing bibs.
- It is a lot easier to correct problems at the bib pick up, than once the bibs and bags have been removed from the area.
- You could also neatly wrap the “club/team group” sheet around the individual bibs and hold it secure it with an elastic band.

Leg Stickers:

Leg stickers with the skier’s bib number are issued when photo finish is to be used at the finish line. If leg stickers are being used, they should be picked in a similar fashion right after a club/team/school has been picked and double-checked.

Bib Picking – Relays

The difference with this process is that the bibs are laid out in piles (of 2, 3 or 4 depending on the size of the relay teams) rather than in groups of 10. If the bib set is a relay bib set, they have probably been stored in groups by team. If no relay bib set is available regular bibs can be used. In advance of bib picking they should have been grouped. (e.g. 101, 201, 301, 401 = team #1). Using a start list, follow the process described in the previous section (for limited space), i.e. call by club/team/school. The rest of the process is the same. When these bibs are checked in after the race, it is important to be sure that all bibs from a team are returned (since only the last bib in the set will be left at the finish line and the rest are usually gathered in the exchange zone). Sometimes (particularly at small high school races) the coaches are made responsible for returning these bibs to the race office, but this has to be communicated at the Team Captains’ meeting.

Bib Picking – Sprint Heats

Each category in sprint heats will have either a maximum of 16 or 30. If you do not have bibs specifically for Sprint Heats (1 – 30, 101 – 130, 201 – 230, etc.), you can use a regular bib set with the same numbering protocol. You can use 1- 30, 31 – 60, 61 – 90, 101 – 130, 131 – 160, etc. if necessary. It is essential that CLEAN bibs be provided for Sprint Heats so hosting a sprint race means you must have enough bibs to do this.

Since there is seldom enough time to sort sprint-heat bibs by club/team, they (and leg stickers if used) are distributed by category to individual skiers who qualified in the qualifying round. The bib-pick list is a copy of the results from the qualifying round but is limited to 16 or 30 skiers per category. (This will have been decided prior to race day.) It is recommended that these bibs be bagged by category in advance of the race day so that they are ready to be laid out on a table for distribution. It is best to have an indoor

location, but the distribution could also be set up outdoors near the start line. Bibs for each category should be available for distribution a minimum of 45 minutes prior to each category's first quarter-final heat. This spreads out the distribution so that those who need their bibs first can get them easily. It is recommended that a minimum of two race-office staff are assigned to this task.

Bib Picking – Leader Bibs (Nationals, NorAms, Provincial Cups)

At major events, season leaders are provided with a “leader bib” instead of a numbered bib. Their number on the start list still applies for all reporting but the skier wears this special bib. This means that once the leaders are identified by the appropriate organization (e.g. Nordiq Canada Race Director for NorAm leaders and someone from the provincial organization for provincial cups), a form is completed that is distributed to officials (start, finish, lap, jury, and controllers) as well as the announcer. A sample of the form is included in [Appendix 4](#). This form is used during the bib-picking process. The clubs with leaders must be identified, the numbered bib REMOVED from the bag (and treated like a scratch bib), a leader bib substituted and the bib-pick list that is in the bag is modified to indicate that the leader bib has been included instead of the number. Remember that when checking in leader bibs after the race, the numbered bib will already be at the race office. Leader bibs will come into the race office by category so the numbered bib should be checked off when each one arrives.

Preparation of Lists and Forms

The lists and forms required will vary with race format. Examples of most, if not all, can be found in the appendices to this manual. While the preparation of lists and forms will have been started before the eve of the race, some cannot be done until close to the start of a race, e.g. Mass-Start Lane Assignments which can only be completed once the start list has been produced. With the Chiefs' requests for the numbers of copies required in hand, duplication of the start list for race day should now be done, along with the setting out the clipboards and pencils for the race.

For an event that takes place over a number of days with a number of races, the paperwork and its management will become a huge function of the Race Office. For large events, it is possible to have five start lists, and five results lists, and if it is all printed/copied on white paper, people may end up using the wrong list for a race. To avoid competitors, coaches, team captains, officials, announcers, etc. from mistakenly looking at and using a previous race day's start list, both the start list and the results list for a particular day's races should be copied onto a specific colour of paper. For example, let the first day's races be printed on white paper, then use pale blue for the second day's races, and pale yellow for the third day's races, etc. Keep the colours pale since copying dark coloured paper results in a very dark photocopy, almost impossible to read. Use pale blue, yellow, pink, green, mauve, etc. By doing this, if an official sees a competitor checking a start list that is not printed on the current day's coloured paper, it is easy to warn the competitor and have them consult the proper day's start list. This use of colour can also be extended to the Controllers' sheets out on the course, so that when they are returned to the CS, they can be filed with the other paper and lists from the same day - easily identifiable by colour.

Race-Day Activities

Bib-Management

The CS and members of the Race Office Team must be at the race site in the race office at least 30 minutes before the announced time for bib pick-up. At the bib pickup location, set up a table or two with the bib packages behind and multiple lists taped to the table. Have enough volunteers to be able to serve a number of clubs/teams at one time to allow them to pick up their bibs quickly. On the second list with each bib package, have the person picking them up print his/her name on the sheet. It is possible that some racers will not arrive at the competition until the morning of the first race, so they might need to complete their registrations and payments. These racers should have been identified by the CS and the volunteer team should direct these racers to the CS before they get their bibs. Remember: NO WAIVER, NO FEE, NO BIB, NO RACE!

When bibs are collected by a team representative, have them check that the bib package is correct (i.e. the bibs are all for their team of skiers, and each person on the list has a bib in the bag). At this time, they may inform you of last minute 'scratches' (competitors on the start list who will not be racing). Record these changes so that the start list can be modified for Start, Control, Jury and Announcing crews. Retain the bib in the race office for any pre-determined scratches. No "scratch" should be regarded as official unless the bib is returned to the race office. Scratch bibs should be kept separate from unused bibs and do not need to be sent for laundering.

The most effective way to collect the bibs at the end of the race is to have volunteers waiting past the finish line to collect them immediately. Competitors usually know that they need to return the bibs. They should be given the opportunity to catch their breath, then be encouraged to pass their poles, and skis and drink if necessary, to a volunteer while they get out of their bibs. If they object, just explain nicely that if they give you the bib now, you will leave them alone to do whatever they want afterwards. Be pleasant, but firm – they cannot leave the finish zone without giving in their bibs. During a race, bibs are collected at the finish line and are to be brought to the race office periodically (either by after-care personnel or race-office assistants). As they are brought in, the race-office staff will check them off a start list. Scratch bibs should also be checked off the list. This will make it easy to identify any missing bibs and which athlete or club needs to be contacted. Missing bibs should be tracked down immediately since they must be laundered and possibly used the next day. If a missing bib is for an athlete seriously injured on course, medical staff will do their best to return it but this may not be possible until much later. If the bib is required for the next day, a clean unused bib can be relabelled with duct tape and a marker.

Protests

In the unfortunate event that a protest is filed, the CS and team must know the correct procedure. A sample protest form can be found in [Appendix 4](#). A supply of blank forms must be available at the on-site competition race office. Protests must be filed within certain time constraints, so check the regulations under which the race is being conducted for the time limit for filing any protests.

The protest must be in writing, be accompanied by a fee and contain the following:

- Name of the complainant;
- date and time of the protest submission;
- time of the incident being protested;

- a full description of the incident, the name or bib number of the person against whom the protest is being lodged, and the grounds for the protest; and
- names of any material witnesses.

Sign and date the protest as accepted and immediately contact the TD and Chief of Competition so that it can begin to be researched and verified, and any relevant information gathered for consideration by the Jury. If the Jury issues a sanction, then a standard format should be followed. Refer to the Technical Package or regulations for the event for protest fees.

Sanctions

The Jury may issue sanctions for issues other than protests if an infraction is observed by an official, in which event, there may be a hearing with the offender. Minutes of that meeting are taken by the Competition Secretariat and this task is best handled by a person designated to be Secretary to the Jury. This is not the case in Sprint Heats (see [Section 4 The Role of the Jury](#)) where sanctions are imposed without a hearing. Whether there is a hearing or not, a Sanction Form will be created (sample in [Appendix 4](#)). The form must be completed and delivered to the offender by the TD. The offender must sign the form and then copies are made and distributed as shown on the form. In the case involving junior athletes, their coach should be present at both the hearing and serving of the sanction form.

Unofficial Results

Post unofficial results as soon as they become available. If the RMS has not printed a date and timestamp on them, add it manually to each page. Then post it on the Results Boards so that the competitors and coaches can review them and inform the CS of any seemingly-incorrect situations. Pass the necessary computer files to the webmaster for immediate posting on the web site.

Official Results

Official results require that the Jury has dealt with any infractions or protests before they can be published. This is usually completed within one hour of the completion of the race. The publication of the official results does require the signature of the TD, thus indicating that all protests have been reviewed and decided upon and that the results are correct. Official Results must reference sanctions (e.g. rule used, reason for sanction, DSQ or time penalty). Make sure all required computer files get to the web site, the official responsible for media liaison, Nordiq Canada, and any other bodies designated to receive a copy in the Technical Package. When posting official results to the web, the webmaster should remove any unofficial results already posted.

Minutes of Meetings

Whenever a Team Captains' (TCM) or Jury meeting is held, minutes should be taken so that a record of the decisions made will exist. Minutes of the TCM should record the members of the Jury, and any changes to the race that the Jury decided were legitimate. For Jury meetings, even if no decisions are required to be made, this should be noted. The minutes can be kept quite simple. Where the Jury has to decide on a protest, more details should be noted concerning the evidence considered and the decision made by the Jury including the number of votes for and against the decision.

Course Salting Notification

If a course has been salted, use of these products can result in competitors and coaches carrying a residue of nitrogen-rich chemicals off site. This can be detected at airport security as an explosive constituent. It is then necessary to prepare disclaimer notes for these people to carry after the event. See [Appendix 4](#).

SECTION 12: COMPETITION SECRETARIAT OFFICIALS

Competition Secretary

Reports to the Chief of Competition

Oversees the following:

- Recording Secretary
- Results Poster
- Secretary to the Jury
- Competition Office Manager
- Webmaster
- Awards Co-ordinator

The Competition Secretary is responsible for communication between the competition committee and the competitors. The Competition Secretary sets up and staffs a race office, manages registration, organizes Team Captains' meetings and draws and produces start lists and distributes results, among other tasks.

Procedure:

The Competition Secretary should:

- Be very knowledgeable about the entire structure of the event and the competition organization.
- Know the majority of the people who are working on the competition, especially chiefs and assistants.
- Be very well organized and able to work under pressure.

NOTE: The number of office assistants and the detail of the organization needed by the Competition Secretary will depend on the size and complexity of the event. For a small event many of the duties can be combined and performed by the Competition Secretary. For larger events, the duties may be delegated and/or shared as outlined under duties below.

Duties:

Pre-event:

- record minutes of the Competition Committee meetings and distribute same to the committee members;
- prepare race sanction applications for governing bodies;
- communicate event information to the webmaster;
- prepare and send the race notice to national and/or Division offices after approval of the TD;
- set up online registration;
- maintain the financial records for the entry fees received;
- prepare the various record-keeping forms for the race officials;
- verify the eligibility of the entrants against applicable license lists including eligibility of foreign skiers;

- ensure the Race Management System has the correct skier names, club, division and race category along with any points necessary for the draw;
- ensure that suitable race bibs have been ordered and are available (specific to the competition e.g. relay bibs or a second set for Sprint Heats), and verify the number sequence of the bibs (i.e. 1-300 or 201-400);
- verify the acquisition of awards and prizes with the Event Committee Chairperson for Protocol and Hospitality;
- arrange for the site of the Competition Office and for the acquisition of all equipment and supplies necessary for its efficient operation;
- set up team mailboxes/mail slots to facilitate document circulation for larger events;
- (N.B. The team has the responsibility to check mailboxes. This can't be the only means of distribution for urgent matters with deadlines, but it can be useful to keep official notices available. Teams should be encouraged to check their boxes each morning upon arrival and prior to departing at the end of the day.)
- collect cell phone numbers and email addresses from Team Head Coaches;
- arrange for a room with appropriate facilities for the team captains' meeting(s) including a projector and screen for the presentation, as well as supplies such as team names for the tables; and
- arrange to train all personnel who will be working in areas responsible to the Competition Secretary. This training should include some conflict resolution skills to aid in diffusing frustrations of athletes and coaches when things are not going their way!

During the event:

- maintain a competition office which will be the focal point of information distribution for all personnel involved with the event;
- maintain and organize the seeding lists if necessary;
- prepare the agenda and presentation material for Team Captains' meeting(s)* with the Chief of Competition;
- arrange to have a sufficient supply of medical declaration forms and waiver forms if necessary and distribute these forms to all team captains or coaches at the beginning of the event;
- collect and keep completed medical forms in a confidential file for use by the Technical Delegate or for Doping Control should a test be made (forms must be collected before the skiers race);
- prepare start lists;
- post start lists online and in declared locations on site;
- sort and distribute bibs and arrange for bib collection after the race;
- prepare and distribute the various forms required in the stadium, on course and in timing;
- post unofficial results on the Official Notice Board;
- receive protests and inform the TD and Chief of Competition of any protests*;
- attend and take minutes at all jury meetings*;
- have the TD verify that the minutes are accurate*; and
- post official results when approved.

*These tasks should be delegated to the Secretary to the Jury or Recording Secretary.

After the event:

- send official results to the sanctioning body (i.e. Division Office(s); CCC; FIS etc.), to the Technical Delegate and/or Technical Adviser and to any teams who did not receive them at the event;
- ensure with the Chief of Timekeeping, Scoring and Data Processing that all electronic dispersal of results has happened as required by the Technical Package (e.g. XML file available for FIS Results submission);
- receive the various record-keeping forms from race officials and maintain them in a file for future reference (these records should be kept until there is no further possibility for any appeal to take place - a minimum of two years);
- send letters of thanks to all sponsors, dignitaries, etc.;
- arrange for the return of all equipment used by the Competition Secretary's committee;
- send or hand over minutes of Team Captains' meetings and Jury meetings to the TD for regional, national and international events.

Recording Secretary

Reports to the Competition Secretary

For smaller events the Recording Secretary is responsible for taking and distributing minutes of all Competition Committee, Team Captains and Jury meetings. Distribution is very limited and filed copies are kept available for review by coaches etc. This role may be better served by a Secretary to the Jury at larger, multi-day events (see below).

Duties:

- take minutes at all race committee meetings and distribute them appropriately;
- take minutes at all team captains' meetings;
- take minutes at all Jury meetings; and
- prepare and have the draft checked by the TD before making copies.

Secretary to the Jury

Reports to the Competition Secretary

For larger, multi-day events, this position better serves the Jury and relieves the Competition Secretary of a significant workload.

Duties:

- prepare and maintain TCM presentations;
- take Team Captains', Competition Committee and Jury meeting minutes (record and distribute them);
- record and distribute Sanction Notifications; and
- release Official Results with Jury approval.

Competition Office Manager

Reports to the Competition Secretary

Oversees the Race Office Assistant(s)

The Competition Office Manager is responsible for setting up, staffing and supervising the competition office. The number of assistants needed in the competition office will depend on the size, number of days, and complexity of the event.

Duties:

- plan the organization and layout of the Competition Office;
- organize the office staffing logistics, i.e., number of assistants and respective training required for their assigned duties, office hours etc., in consultation with the Competition Secretary;
- arrange for the computer, printer, photocopier, fax machine, telephone(s), paper and office supplies necessary to run an efficient office;
- obtain, copy and prepare for distribution all the forms needed by the various race officials and teams;
- arrange a mailbox and message board system in the competition office;
- maintain the race office for information flow during the event to serve athletes, coaches and press as well as officials and race committee members, etc.;
- copy and prepare for distribution sufficient numbers of copies of the official race results;
- set up an efficient filing system for forms and results, including a confidential file for the athlete medical declarations for the TD; and
- receive and/or keep files for the following:
 - Athlete sanction or injury report forms
 - original forms, letterhead and logos;
 - all original results, signed by the TD;
 - all completed medical declaration forms (in the TDs confidential file);
 - all forms used by the various race officials;
 - oversee the bib pick and all communications with users of the Race Office.

Helpful hint: Keep a three-ring binder with all the entry forms, copies of forms, etc. This becomes the Competition Secretary's "Bible".

Race Office Assistants

Reports to the Competition Office Manager

Duties:

- assist the Competition Office Manager/Secretary to the Jury in arranging a room with appropriate facilities for the team captains' meeting(s) - set up the room with chairs, tables, team names, projection equipment and screen, stationary, forms, and refreshment tables etc. for the meeting(s);
- sort the bibs into groups by country, division, team etc. as appropriate to the race;
- assist in the distribution of bibs to teams or individual athletes;
- assist in the preparation of the various forms required in the stadium, on course, and in timing;

- assist in collecting bibs during and/or after each competition if finish volunteers are not assigned to do so;
- assist in checking and reorganizing the bib set after the competition to ensure that no bibs are missing;
- launder and organize bibs for next competition; and
- keep a key registry for the wax rooms.

Results Poster

Reports to the Competition Secretary

Duties:

- post unofficial results in the designated location(s) as soon as released by the Competition Secretary; and
- post Official results when permitted by the Jury and remove unofficial results.

Webmaster

Reports to the Competition Secretary

Duties:

- post all information required prior to the competition ([see Appendix 4 - Race Notice Contents](#));
- add updates as soon as possible prior to the race;
- post race entries by category as they arrive;
- post start lists immediately they are available;
- post unofficial results as soon as possible;
- post official results when authorized and remove any unofficial results; and
- add photos and athlete stories when available.

Awards Co-ordinator

Reports to the Competition Secretary

Duties:

- Have the announcer call athletes and spectators to the awards location at the time scheduled;
- communicate with and direct any VIP's giving awards; and
- ensure physical awards and prize money are delivered

SECTION 13: TIMEKEEPING, SCORING AND RESULTS SYSTEMS

Introduction

The sole objective of timekeeping and scoring is to provide prompt and accurate results. This statement supports the adage that: “give the racers good tracks and fast accurate results and they will be happy”. The expansion of the mandate to Timekeeping and Scoring reflects the fact that timekeeping officials provide results for sprint heats, where not all are “timed”, but “scored”. This may not be the entire story for the organization of cross country ski races, but it does state the two most important functions from a racer’s point of view. To ensure that fast and accurate results can be prepared requires attention to detail and the organization of at least two independent timing systems with dedicated teams. Having two systems insures against failure and ensures that there are times with which to produce results. Ideally the two systems should use different technologies or at a minimum be on separate computer networks.

Any number of unforeseen problems can occur on race day and it is always wise to have a back-up timing system. Cold temperatures, snow, moisture and wind can affect electronic equipment, although modern equipment is very robust and reliable. Power failures can shut down computers, so the provision of backup power supplies is definitely advisable. Bibs which are rolled up and/or hard to read, or several racers finishing simultaneously, make recording difficult on course and at the finish line. Timing teams must therefore be well trained, organized and equipped for the job.

Technology is constantly improving, is easier to operate and is becoming more readily available at more reasonable cost. Therefore, this Manual assumes that all competitions will be run with electronic timing as the primary system and manual timing as backup. Any race decided by order of finish presents the finish crew with the challenge of close finishes and high rates of arrival of skiers. As a result, the use of video aids such as cameras, tablets and photo-finish equipment are essential for championship and selection races. Once again, training in use and interpretation of results is essential.

Tools of the Timing Trade

Electronic Timers

The electronic timing system offers improved accuracy and efficiency to the production of competition results and is a requirement at major competitions. This equipment is expensive to purchase, and clubs may choose to work in partnership with other community sport groups, such as track and field or swimming clubs, to acquire some or all of the equipment necessary to meet their needs. Another way to access equipment is to contact your Division office. Some Divisions of Nordiq Canada have timing equipment available for the use of their member clubs.

Organizers should use timing equipment compatible with a race management system specific to our sport. An additional benefit of electronic timing equipment is that it can be directly connected to the results computer. This saves time and eliminates inaccuracies caused by manual entry.

Automatic backup battery power is strongly recommended for any devices such as PC's and printers using AC power. The backup power ensures that power failures or temporary power fluctuations will not delay the production of results.

To time a cross country race, times have to be taken from several locations (timing points) like start, lap and finish. Recently, we have seen the near complete adoption of wireless timers from Summit Systems in Salt Lake City, Utah. A timer or two can be placed at each of the timing points to communicate by wireless signal to a modem, putting times directly into a PC. The PC can be equipped with Zone 4 or Summit Systems Data Acquisition software and all that is required is to relate a bib to a time – which is easily accomplished by the Summit's capacity for a bib number to be posted/entered on its keypad, immediately updating the timing file. Additional benefits are the ability to synchronize all the timers from one PC signal, and they can be started well before the race is to start. They can be started at zero, a negative time to count down to zero, or in 'real' time. The last option is increasingly popular because everyone can relate to a time represented by their watch or phone. Summits are powered by AA batteries which can be changed while the timer is running. In the following description of deploying Electronic timing devices where a multi-channel timer would be wired to a channel, a single Summit is deployed. They are essentially weatherproof and can be used at any temperature permitted for ski racing.

Electronic Timers will be connected to personal computers, either desktops or laptops. For larger races, (i.e. over 100 skiers), it is recommended that several computers be networked but access a single race database. In this way starts, laps and finishes can be monitored on a single unit by one operator. Another unit can then be used to update the file for Did Not Start, Did Not Finish statuses and produce interim unofficial results while the race is progressing. A further benefit of the network approach is that if any one of the computers fail there are others connected to the race database and their initial purpose changed.

What devices and channels are used?

Interval-start races should use a start gate with the wand positioned over the start line and connected to the 'start' timer. It is positioned approximately 25cms above the snow, and the skier 'opens' the gate when they move forward at the start. A switch inside the start gate causes a time to be registered in the timer. The best type of start gate is FIS approved and swings completely open on a spring once it has been opened beyond about 15%. The wand then needs to be pulled back into the 'set' position by the Starter. For Interval-start races a skier is permitted to start between three seconds before and three seconds after their designated start time. If no start gate is available this is referred to as a "manual start". The skier's start time is counted down by the starter (usually 5, 4, 3, 2, 1, GO), before which the skier must not leave the line, and their start time appears on the display clock. There is no start 'time window' if a start gate is not used.

Precautions need to be taken with the start gate in free technique races. A fixed post needs to be positioned within one metre of the start gate post on the start line to force the skier close to the start gate post. If this is not done, it is possible for a skier to move their leading leg forward, fail to open the gate sufficiently and then have their trailing leg entirely miss the gate.

Para Nordic Considerations

When using a start gate, visually-impaired skiers start through the gate, but guides must start alongside or in front of their skier. Start-gate wand height is set at the standard 25cm above ground level. For sit skiers the height of the wand is 60cm above ground level. If the width of the gate has been restricted by the fixed post mentioned above, ensure the skiers sled will fit through the gate. If it will not, then the sit skier should start outside the gate and a start official opens the gate when they start.

Finish Timing

At one end of the finish line there is a photocell or laser light beam that projects to a reflector or other light source at the other end of the finish line. When the beam is broken by a skier passing through it, a signal is sent to the timing unit to register a time. The beam is required to be set 25cms above the snow, so any features like a laser aiming aid is definitely a benefit. Ensure the beam equipment is compatible with the timing unit before making the purchase; and remember it needs a range of at least 12 meters to cover four three-metre lanes for Sprints, and it needs to work down to -20 C .

All other signals to the timer are usually made by grip switches, more commonly called plungers. The plunger is cylindrical, is a little larger than your thumb and fits in the palm of the hand. On one end is a spring-loaded button which requires some pressure to close the internal switch. Some have a guard ring around the switch. This means in winter a thickly gloved hand may not break the switch. If you are wearing mitts, put the plunger inside and work it with a finger. Elsewhere we will describe in detail how to time using a plunger. Typical uses would be to capture lap times, backup finish-beam signals and start-gate signals.

The only other device which may have some applicability to our sport is a sound transducer which can capture the firing of a start gun and generate a signal to the timer. Some start clocks (notably those supplied by Alge) have a port which can be connected to a horn. In this way a Starter can watch the clock count down to a mass start time, press a plunger and simultaneously sound the horn and capture a time on a Summit timer.

Display Clocks

The primary use of a display clock is to show officials and skiers the precise race time. They should be deployed close to the start and be visible to skiers warming up. The best clocks are double sided and should run on batteries.



Illustration of a display clock.

Start Clocks

These devices are specifically designed to signal start intervals and use 'traffic' lights to show the skier the count down and start window. Programs are available for many start intervals, although we typically use 15 or 30 seconds. They are expensive but do represent the best way to start interval-start races. They can also be used without a specific program as an additional display clock.

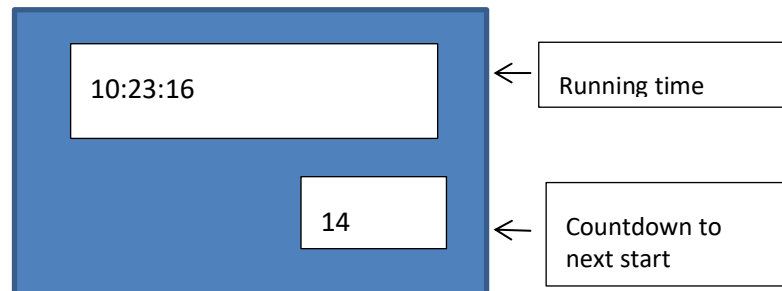

The Green Light will be on for the permitted start period i.e. +/- 3 seconds from the start time. The orange light is on five seconds prior to the start time. At all other times the red light is on. In the diagram above, the next start time is 10:23:30 and it will be in 14 seconds time.

Printing Timers

These hand-held timing devices make excellent backup to the electronic timer. They print times on a thermal print roll 3.5cms wide. The major disadvantage of these products is that times need to be keyed into the computer producing results. The most widely used is the Seiko range of products. While they only have one channel they can be operated with a plunger and they have the additional feature of a lock to prevent stoppage of the watch once started.



Headsets

Although the wiring for headsets is a significant extra task, there are major benefits for some communication to be completely open rather than one way as would be the case with a radio. Because a headset network is always open, emphasize discipline to communicate necessary race information only and not carry on long conversations.

Radio communication is less suitable for the information flow needed for timekeeping and results. For some roles like Finish Bib Caller, a radio with voice-activated-transmit feature can be useful, but this requires a word of preamble to activate the line, such as "Bib Number" followed by the actual number.

Equipment Setup

Following are some additional considerations:

- All systems should be synchronized to the same master clock.
- The required Nicad battery units require special care. They should be drained and re-charged as instructed.
- Electronic timing equipment must be kept in a heated environment prior to and during the event. Do not leave it in your car the night before the competition.
- Timing units must be placed in a position that provides the operator a clear view of the timing point (finish line or lap lane).
- The plunger buttons should be kept warm, dry and free from snow.
- Set up fencing or guard posts to prevent start- and finish-area skiers and officials from interfering with the finish beam and to protect the start wand from skiers.
- Check the recording resolution of the finish beam (photocells).
- Check the operation of all timing input units including; plungers (buttons), start gate(s), photobeams, radios or headsets from each location.
- If a start clock and display clocks are used for countdown purposes in interval starts, they must be placed so that they are in view of the starter and the skier in the start gate.
- A display clock must not be visible to skiers in mass/relay starts but should be placed at the finish line where timekeeping officials and finishing skiers can both see it clearly.
- The crowd display unit (if a second display unit is available) should be placed so that it can be viewed by announcers and spectators. This clock must not be in view of skiers during mass/relay starts. If this clock is used as a time of day clock, it should be set very early in the morning so that coaches and athletes can set time according to it.
- For a pursuit start, a minimum of two display clocks should be positioned outside the outer lanes on stands or tripods, as high as is practical, ten meters beyond the start line.
- The cables for the start gate, finish beam etc. must be protected from skiers, officials and grooming equipment.
- Applying strain-relief measures to timing cables is essential so that they cannot be inadvertently unplugged.
- Two timing units should be used at each timing point; one unit is then part of a back-up system.
- In case of equipment failure, (start gates or beams) plunger buttons should be installed for additional backup.

Operation of Electronic Timing Equipment

It is essential to rehearse the electronic timing procedures, communications and information flow. These rehearsals should include practice for equipment failure and other unexpected circumstances. Practice will allow efficient operation in difficult situations including multiple finishes and power failures. Make sure spare batteries are available for equipment that uses them, that they are kept warm and that the operator knows how to change them.

Specific use of electronic timing systems will vary with race format, but the operator and timing team should rehearse race starts. As previously mentioned, a feature of Summit timers and the software used with them is that they can be started well before the scheduled race start. In order to start backup timers at zero, the Chief of Primary Timing should gather them around a Summit deployed to the start, and as it counts down to zero, call out the count down so the backup timers can be started. Transponder (commonly known as 'chip') technology is useful for recording the passage of skiers past a timing point. It does not give the official result. Start gate and finish beams are required for interval-start races, and 'order of finish' races are judged by photo-finish judges.

Roles change significantly with race format and these changes will be highlighted in the description of the roles of officials.

Plan for contingencies in case any part of the system fails.

Starting Procedures

The start of the timing system is usually carried out by the Chief of Timing and Results.

Interval Starts

- The first skier usually departs at 30 seconds (or whatever start interval is chosen) after the race start time. Skiers continue to depart at the chosen interval unless a break in the start sequence has been scheduled into the official start list.
- If a skier fails to come to the Assistant Starter before their start time, the Assistant should stand in the place of the missing skier until the 'missed' start time is passed. In that way there is no chance of a skier starting early in place of another skier.
- When a start gate with wand is used, the skier's start time is measured accurately to 1/10 second. The skier is permitted to start up to three seconds before their designated start time and up to three seconds later than their designated start time. If the skier starts more than three seconds early, it is a false start. The incident must be recorded and reported to the Jury and a sanction of a time penalty may be applied. If the skier starts more than three seconds late, their race start time is that given on the start list.
- 15- or 20-second start intervals can be used where it is desirable to start the race in a short time. For example, the qualification round for a sprint race can be done this way. If it is necessary to use one of these interval times, rehearse carefully ahead of time.
- Skiers who come to the start after their designated start time are 'Late Starters'. They should not pass through the start gate. Instead, under the control of the Starter they are started in a lane

adjacent to the start lane having come to a stop before starting. They are then started as quickly as possible but not at a time which will interfere with an on-time starter e.g. five seconds after an on-time skier. If the start interval is shorter than 30 seconds, late starters should be controlled and started by another official. Their actual start time should be recorded and adjusted if they can show the Jury it was not their fault but that of an official. Otherwise the start time used to calculate a result for a late starter is that given on the start list.

Mass/Relay Starts

- Skiers will be told to take their positions two minutes before the scheduled start. They will then be given a one-minute warning and must assume their start position. The starter will announce “30 seconds”, and to follow this with the sounding of the start signal (shot or horn) to start the competition. A countdown
- (i.e. 5, 4, 3, 2, 1) is not used so as to avoid false starts.
- When the start signal is sounded, the electronic timing system and manual watches are activated by whichever method has been selected.
- If a number of mass starts are scheduled on the official start list, the same procedures are followed for each group of departing skiers.

Pursuit Starts – with a break

- The tenths of seconds are removed from the times in the official results of the first competition to provide start times for the second competition (pursuit start).
- A start-list-by-lane must be prepared to ease the task of ‘loading the grid’ ([see Appendix 9 - Pursuit Start List with Lane Assignments](#)).
- Start-order charts (with suitable stands) for each start lane must be prepared in advance with pre-determined bib numbers with start times (several per page with large, easy-to-read digits). At the bottom right hand corner of each page, note the first start time on the following page. Try to find a significant gap (>20 seconds) between start times in a lane to choose where to start a new page on the chart. It is a good practice to use a colour marker distinct from that used for the other information on the page. There may be only a few seconds between subsequent starts in any lane so there may not be sufficient time to flip the chart at the end of each page.
- The recommended procedure is for the Starter to begin the event by firing the starting pistol.
- There is no countdown, and the start signal (shot or horn) is the signal to release the first skier.
- Skiers continue to depart at start times predetermined by the results of the first of the two events that comprise a pursuit competition.
- The Assistant Starters in each lane need to be vigilant for skiers who do not show up for the start of the second leg. They need a Lane Assignment sheet and should stand in the lane as for an Interval Start until the missing skiers start time has passed.
- Racers who start before their assigned start time are sanctioned with a time penalty.

Sprint Heats

- When the first six competitors enter the starting area for the first round of heats, the person with the best qualifying position gets their choice of start lanes; the second best qualifier in this heat gets the next choice, and so on, until the six lanes are selected. The start sheet for each

round and heat should indicate which competitor has which choice so that the Assistant Starter does not have to figure this out at the line. Ideally bibs were re-issued in order of qualifying so for the first round of heats the skiers choose lanes in bib order.

- For the subsequent heats (semi-finals and finals), the start lane selection depends on whether the heats are timed or not. Quarter final winners choose first followed by runners up. The remaining two start positions are 'Lucky Losers' and this process is fully described in [Section 4](#) of this manual. With timed heats their selection is based on who were the fastest two in 3rd or 4th place. If the heats are not timed the 3rd place finishers who qualified fastest are chosen.
- For each heat, the racers must be called to the pre-start line where the racers choose their start lanes (in order). Instructions are given as to what the starter will say to get the racers ready to start and what the start signal will be; and any questions that arise at that moment are answered.
- Once the Starter is ready to start the heat, he/she will call to the racers to move to the start line by the instruction "Take your positions"; and give them a chance to settle into their start positions. Once the Starter sees that the racers are set and motionless, he/she calls "SET" and within 2-5 seconds fires a gun or horn to start them. If there is a false start, the Starter will signal to the False Start Controller, who will in turn step out on to the course, flag the racers to stop, and return them to the start line, where the procedures will be repeated fairly. It is imperative that no one "jump the gun", but it is also imperative that the starter not hold them too long in the ready position or get into a cadence that is so predictable so that many racers can anticipate the start signal.

Note: for sprint heats that are timed the start time must be captured. This can be achieved in several ways. The starter can be given a gun or horn which is also connected to a wireless timer or the wireless timer can be equipped with an acoustic sensor for a gun, horn or whistle. The systems do need to be interconnected as a manual signal is not accurate or consistent enough to give accurate results.

Determination of the interval between sprint heats is made depending on the course (its length and the time required to get around it) and the site where it is held. However, it is also normal for a heat to be started before, but not coincide with the previous heat coming to the finish line. There is often too much noise at the finish for starting competitors to concentrate on starting and to hear the "GO" command - a restart because racers could not hear due to spectator noise should not occur. This competition is full of action, and we don't want to have large gaps of non-action that will dull the interest of the spectators and teams. If quarter finals, semi final and finals are run in quick succession there are prescribed rest periods required between rounds and these will be found in the Technical Package for the event.

Finish-Line Procedures

Before giving detail about each type of race, a note about precision. All races results are given to a precision of 1/10 second except Sprint qualification which uses 1/100 second. At most races, skiers travel across finish lines at between four metres per second for U14 skiers and 10 metres per second for Olympic Sprinters. 1/10 second represents 40 to 100 cms and it is usually not difficult to determine which signal from the finish beam belongs to which skier. If two or more skiers only give one signal, they have the same finish time. 1/100th of a second represents 4 to 10cms of travel and that could be less than the 'width' of a skiers' shin. This is one reason why it is best to arrange the start order of sprint qualifications with the fastest skiers starting first. Each skier needs their own time, so any steps taken to

avoid overtaking are beneficial. If there is no finish beam in use, 'normal' fingers cannot generate repeated 'plunger' signals closer than 2/10th second.

Sprint heat finishes can be organized like any other mass-start race, but video or photo finish is essential to collect the correct order of finish. This is especially so when heats are timed. An alternative process which still needs backing up with video or photo finish has an official only calling the order of finish by lane from alongside the finish line teamed with a judge for each of a maximum of four lanes recording the bib numbers of the racers in each lane. A consolidator official then takes the lane order of finish and then adds the bib number from the recorded lanes. Lanes need to be clearly marked as shown in the following picture so the Finish Lane Judge can call the lane numbers.



Forms appropriate for this process for recording finishers can be found in [Appendix 9](#).

Interval-Start Races

Electronic Timing

The makeup of timing teams is described in detail in [Section 14: Timekeeping and Scoring Officials](#). However, there are certain key points that need to be made. The Electronic Timer Operator should concentrate on the finish line to make sure that the correct signal is given to the correct skier. Poles close to the beam source can cause a signal. Skiers alongside each other may only make one signal for two or three. They all get the same finish time but remember they started at different times and their elapsed time for the race is now known to the nearest one tenth second. In order to keep the number of recorded finish signals the same as the number of finished skiers, a plunger operator can be positioned by the finish line with instructions to plunge once for each finisher. Bear in mind, however, their times are taken from the beam as a 'plunger finger' would separate the skiers by about 0.2 seconds which represents 80-200 cms.

Backup Timing – Printing Timers

Form at least two independent teams of three. Position teams on opposite sides of the finish lanes. One person is the Bib Caller who calls the bib numbers in the order in which skiers cross the finish line. The Bib Recorder captures the bib caller's order on a Time Record form. The Backup Timer concentrates on the finish line and presses the 'Split' or 'Lap' button when a skier's toe reaches the line. If traffic is low, the time can be transcribed onto the "Time Record" but this is not strictly necessary. The best form (see sample at [Appendix 5](#)) has room for 10 skiers and their times, and provides large enough spaces for the gloved hand to write when working outside. Forms for use inside a timing hut can have smaller squares

and accommodate 20. The Bib Recorder should write at least one time on each sheet to maintain synchronization, and also to keep forms in order if the recorder omitted the page number and the forms are dropped. When the printing timer paper is advanced for tear off, it is important to check that the number of times equals the number of bibs. It is possible for even the best of timers to miss one or capture extra times, but they usually know when they have made an error. Mark the timer tape to show any such errors. Staple the timer tape to the Time Record since this tape is very flimsy and can be carried great distances by the wind if it gets loose. Then have a runner carry the forms and tape to Calculations. (The runner may carry a plastic bag to protect the forms against wet snow and rain.)

If two or more skiers are very close (say within one metre), they have the same time. However, the ordinary human finger can only repeat in two tenths of a second or up to 200 cms of skier travel. 'Click' twice to record two skiers but note on the Time Record that the skiers should have the same time.

Manual Timing – non-Printing Timers (i.e. a stopwatch).

Use of non-printing timers as the primary means of timing a race is not recommended. It can be done but timing precision can only be achieved to one second. Form two independent timing teams of four. Position teams on each side of the finish lanes. One person is the Bib Caller who calls the bib numbers in the order in which skiers cross the finish line. The Bib Recorder captures the bib callers order on a Bib Record form. The Manual Timer concentrates on the stopwatch and reads aloud the times on the stopwatch as a skier approaches. For example, they will read: "twenty minutes four seconds, five, six, seven, eight, etc.". If another skier is close behind, the Manual Timer should keep reading the seconds aloud until no more skiers are approaching. The Finish Time Recorder writes on a form the time (initially the second) that he/she hears at the exact moment when a skier's toe hits the line. For example, he/she writes 20:07 on a Time Record form (more likely, the Finish Time Recorder writes "07" and then, when there is a lull, goes back and writes the minutes in front of the seconds (in this case, "20")). When the traffic dies down, transcribe the Bib Recorder's information on to the Time Recorder's form and you have a Time Record that is complete. Complete the transcription as frequently as possible. The reason the watch is not 'split' (i.e. the split/lap button is not pressed) is because there is little likelihood it can be reset and recalled if several skiers arrive within, say, two seconds. However, they likely started at different times and their elapsed times for the race are now known to the nearest second. Unless the skiers are well spread out, there will be more bibs than times as some skiers may finish in the same second.

Mass/Relay and Pursuit-start Races

Electronic Timing

Although the result of this type of race is determined by order of finish, in most races time is also critical. Skiers are frequently awarded points based on their times relative to the winner and these points can be used for team selection. Timing teams must be acutely aware that a finish beam will not create a separate signal for every racer. The beam can only 'see' transitions from 'dark' to 'light'. Racers close together may only produce a single signal for several 'lead legs', with more signals generated for 'trailing legs'.

If a skier falls on the finish line this is a very good example of why backup is necessary. Until the finish beam is 'unblocked' no times will register. Plunger backup for the finish along with manual printing timers will enable every time to be captured. As a last resort, the time between the last good signal and the first after restoration could be divided by the number of skiers (plus one) who finished while the beam was blocked

Printing Timers

The procedure is the same as for interval starts but the result is the order of finish with the time being of secondary importance. There is no magic, just vigilance, and practice on the part of the Finish Referee with video backup.

Non-Printing Timers (i.e. a stopwatch).

This type of watch is not suitable as the primary timing system where order of finish matters, since times can only be given to a precision of one second. It can however be used as a 'last resort' backup timing system.

Sprint Heats

The results of sprint heats should be decided by the Finish Referee calling the order of finish since sprint heats are not timed. However, close finishes sometimes require assistance. A Finish Referee may be able to decide order of finish by lane by concentrating on the feet to the finish line. They can then call the order of finish by lane to their recorder. To ensure the correct finishers in each lane are captured, Finish Lane Recorders should be used. Their input should be consolidated onto a Finish Lane Record and passed to the Bib Recorder assisting the Finish Referee. If the Finish Referee wants a second opinion without resorting to video replay, a Bib Caller on the opposite side of the course should also call order of finish by lane to their own Bib Recorder. Video should be deployed as described below.

Because the result of each heat influences the progress of skiers to more heats, results need to be posted immediately. Heat results should be collected in the Timing Hut which is now functioning as Race Control. The results can be entered into a PC and relayed by headset or radio to the Results Board. At the end of a round (e.g. quarter final, semi final), the next heats would be printed and passed to the announcers and start line officials.

Camera Technology

There are currently several methods of recording the finish order, each with a varying precision and expense. The Technical Package for an event may mandate which technology is to be used.

Use of Standard Consumer Video Equipment

Standard consumer video equipment at the finish line is used to establish or confirm an order of finish in close races. Technology continues to advance so there are no specifications listed here. However, here is a list of requirements:

- Two cameras with compatible digital recording media will be required along with spare media and a playback monitor.

- Camera 1 is placed just past the finish line at an angle of approximately 5° (five degrees) to the finish line opposite a finish post to establish which skier (boot) arrived at the finish line first. The camera is not exactly perpendicular to the finish line so that a foot or leg of a skier nearer the camera cannot block the view of a foot further away. This camera position is not used when a photo-finish system is in place.
- Camera 2 is placed 20 metres before the finish looking at the backs of finishing skiers to establish which skier finished in which lane (the finish-line camera only shows feet).
- A playback monitor is used to view media from Cameras 1 and 2 so that races may continue as the officials review video images. Make sure that any media removed for playback is immediately replaced by blank media for the next heat's recording. Set aside appropriate indoor space for reviewing video without impact from other activity such as the Timing and Results crew, First Aid, or the Race Secretariat. A runner will bring the video to this location.

Use appropriate precautions to keep the cameras functioning in poor weather and for long periods, such as using waterproof cases, spare batteries, or AC power. In some cases, the cameras may not function in sub-zero temperatures, so they must be heated or installed indoors.

Video Camera Set-up Detail

It is very important to ensure that the camera is positioned correctly to ensure a good, clear image. Experience shows that there should be a camera placed just behind the finish line so that the line of sight is about 5° off the line of sight along the finish line. It also needs to be set about 30-60 centimetres above the ground so that it can capture the whole finish line (remember that the finish line is about 12 metres wide). In setting up the camera, have four volunteers put one toe of a boot on the finish line, and wear a brightly coloured article (such as a piece of red or yellow warning tape) just below the knee to see that the camera will capture from the toe of the person in the closest lane to the knee of the person in the farthest lane. Ensure the camera used for lane determination captures all the finish lanes.

Reflecting on the comments above about precision, skiers may be given the same finish time since scoring is to 1/10 second, but the order of finish is paramount. Skiers need to be confident that the finish order is correct even if they are a few centimetres apart and are given the same time. This is where video equipment comes in to play. For some races, resolution to 1/1000th of a second is required, such as the sprint-qualification round. The photo-finish system may aid in ensuring the correct precision here also.

Use of Photo-finish Equipment

Unfortunately, the maximum resolution available with a standard video camera is, at best, a little more than 3/100ths of a second (some record up to 30 frames per second) and, at worst, a little more than 4/100ths (1/25th) of a second (standard NTSC video is recorded at 24 frames per second). As mentioned above, this can account for up to 40cm of travel by a fast skier. Further to this, with consumer-grade equipment, it is often difficult to stop or pause the playback at the exact instant the first toe crosses the finish line.

As the sport advances, skiers are traveling at faster speeds every year. This has made the use of standard video equipment somewhat obsolete, since the maximum resolution is so high, and a great deal can happen in 30-40 cm of snow. As a result, we have had to look at newer technology that can record finishes at up to 1000 frames per second (FPS), though it is typically configured to work at 500 fps. At 500 fps, we can account for 2/1000ths of a second, which is no more than 2cm of travel. Additionally, due to the technology involved, we can be certain of the finish order and the finish time.

[Zone 4](#) has a RapidCam product that can time skiers and detect bib numbers. FinishLynx system from [Lynx System Developers](#) is widely used in track and field so local rental or loan may be possible along with the expertise to use it. These cameras act as network devices and are connected to a computer that records the data. The connections to these cameras are done through the use of a 10BASE-T Ethernet network. It is recommended that this be a separate network from your other applications due to the bandwidth requirements.

As the setup and operation of the system is not like anything else, the photo-finish operator must have received training on the specific equipment to be used. This individual must also co-ordinate his/her efforts with the Chief of Stadium to ensure there is adequate space available for the equipment.

Photo-finish Setup

The physical setup of the cameras is relatively simple. Using two cameras (one from each side of the finish line), you must align the cameras with the front edge of the finish line marking, which is accomplished in a precision method using the built-in viewfinder. Each camera must be capable of capturing, at the very least, all but the furthest lane, but ideally, all lanes should be visible.

Each camera is then connected to the network and electrical power. The computer software is then started up and the correct operation and alignment is verified. The capture feature is enabled and synchronized to the timing system. Once this is complete, the areas between the cameras and the finish line area must be cordoned off, and the finish area officials, along with the TD and Chief of Competition, must also be advised of this “no-go” zone. This should be completed no later than one half-hour before the race starts.

This synopsis is not intended to replace training on the equipment, but to provide a rough guideline on its use. The photo-finish camera operator must receive training specific to the brand of equipment in use at the race, with sufficient time to be able to co-ordinate his/her efforts with the relevant race personnel (e.g. Chief of Stadium).

Lap Times

Racing is now taking place on shorter courses than was the norm 20 years ago. As a result, many races are made up of multiple laps. Lap times should be taken when skiers lap through the stadium and ski over a line marked in the snow designated as the lap line.

The procedure for Electronic timing is as follows: the Bib Caller determines and calls out the order. (One option is for this person to wear a headset and the recording be done in the timing hut.) As a backup they should have a Bib Recorder assigned to them outside and also have a voice recorder (perhaps a smart phone app) to record the order of a ‘train’, which can be played back when the traffic dies down. Alongside the Bib Caller should be a Timer signaling the time for each skier with a plunger.

Results Systems

The production of prompt and accurate official results is the primary purpose of timekeeping and the results system. The results system is now expected to provide continuous, up to the minute, unofficial results while the race is in progress.

The official results are produced by timing the racers as they pass the various timing points and cross the finish line. The elapsed times between start and finish are then calculated. Once the skiers' times are calculated, they are then sorted from fastest (least elapsed time) to slowest (greatest elapsed time), checked for accuracy by the results checker, and posted (as unofficial) for scrutiny by the racers and coaches. The unofficial results are then corrected, if required, and forwarded to the Jury for approval and to be made official. This activity meets the formal requirement for the competition but does little to tell the skiers, officials, and most importantly the spectators what is happening while the competition is in progress.

The second purpose for the results system is to inform all those attending the competition of what is going on in an "up to the minute" and exciting fashion. The unofficial results boards, scoreboards, and the announcing team are responsible for distributing this information. The recent changes in course and race formats are also helping to raise spectator awareness and make it easier for them to follow a competition. This is done by bringing the racers through the stadium more often and by using mass starts and pursuit events.

Sprint-Qualification Round

The results of the qualification round are very important, especially for the last one or two competitors who just make the cut-off to move to the sprint heats. So, there can be no shortcuts to the results production process that is gone through, similar to a normal interval-start race. The times must be accurate to 1/100th of a second; they must be posted as soon as possible for their verification and the lodging of protests by athletes and coaches; they should be verified as usual within the results production function; and protests must be ruled on, etc. For it is from the final official results list that those who move to the sprint heats are chosen and seeded into heats.

Cross country ski competition organizers must pay more attention to the unofficial "in progress" results system to:

- increase knowledge of the sport;
- increase excitement in the sport;
- increase marketability of cross country skiing for improved sport reporting and sponsorships;
- increase enjoyment and support for our racers; and
- encourage more people to cross country ski and to compete for fun and/or glory!

The level of organization for an unofficial "in progress" results system depends on the level of competition being organized and should be as sophisticated as possible. Live timing to the internet is also available.

- Division Cup or Loppet - an Official Notice board and an Announcer.
- Canada Cup/NORAM - an Unofficial Results Board, Official Notice Board, Announcer, Announcers Assistant.
- National Championship - an Unofficial Results Board, an Official Notice Board and a full announcing team.

Electronic Timing System Information Flow

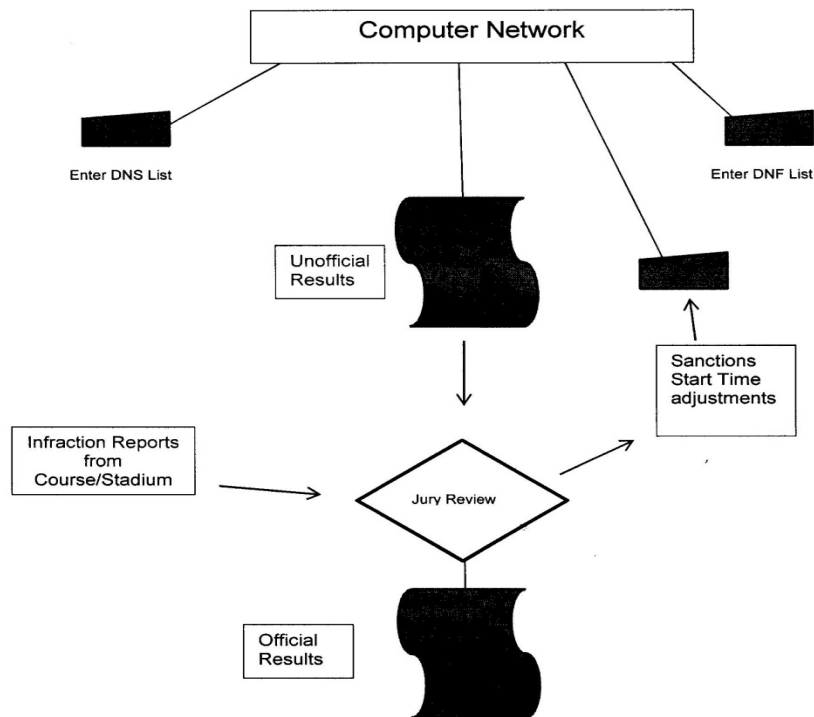
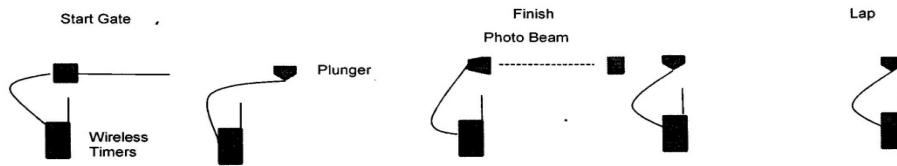

SECTION 14: TIMEKEEPING AND SCORING OFFICIALS

Chief of Timekeeping, Scoring & Data Processing Officials

Responsible to the Chief of Competition

Oversees the following:

- Chief of Start
- Chief of Primary Timing
- Chief of Backup Timing
- Announcer
- Awards Results Compiler

Chief of Start

Reports to the Chief of Timekeeping, Scoring & Data Processing

Oversees the following:

- Starter
- Assistant Starter
- Start Controller
- Chart Steward
- Start- Time Recorder

The Chief of Start is responsible for staffing the start area appropriate for the competition format and ensuring all officials are knowledgeable about their individual roles and responsibilities.

Equipment:

- clipboard, pencils, timer batteries, timer printer paper

Starter

Reports to the Chief of Start

The Starter is responsible for starting individual racers for interval-start competitions at the correct time and doing the same for the whole field for other formats. For pursuit competitions there will be a Starter designated for each lane.

Procedure:

- For interval-start competitions the Starter will give start commands (verbally 5, 4, 3, 2, 1, GO or optionally allow a start clock to signal the start) to the racer in the start position.
- For mass-start competitions the Starter gives the commands required to the whole field: i.e. providing a two-minute warning; briefs the field about skiing in the start lanes right until they end; states that the last warning before the start signal will be a 30-second warning; and finally gives the start signal (shot, horn, whistle or shout “GO!”) at the correct time.
- For sprint heats they give the commands “take your start positions” and “set” and then sound the start signal.

- For pursuit competitions, the Starters may allow the racers to start themselves when they see their start time appear on a display clock. If a Start-Time Recorder is not available, the Starters will need to record any early or late starts.

Equipment: None

Assistant Starter

Reports to the Chief of Start

The Assistant Starter is responsible for presenting racers to the Starter for interval-start competitions. For other formats they are responsible for ensuring racers are correctly positioned for the start.

Procedure:

- For interval-start competitions, the Assistant Starter presents the next racer to the starter at the correct time. That time is when the previous racer has started, or if a racer is missing, when their start time is the next interval.
- Their further responsibility is to step in when a racer is missing (either Did Not Start or is late) to ensure the next racer does not start early. Late starters do not get started by the Starter. With 30-second intervals the Assistant Starter could start the racer. For 15-second starts another official should be charged with the task.
- For mass-start competitions, Assistant Starters ensure racers are in their correct positions on the start grid. In addition, they should mark their start sheets with those present on the grid. By consolidating several such sheets nonstarters can be identified.
- For sprint heats, Assistant Starters allow the racers to select their start lane in the order designated by the rules (See Section 4 Ski Techniques and Race Formats).
- For pursuit competitions, the Assistant Starters (one per lane) should ensure racers know their start time, and as with interval-start procedures, ensure they don't start early if a racer is missing.

Equipment:

- clipboard, pencils, start list.

Start Controller

Reports to the Chief of Start

This official notifies racers to be prepared to start (i.e. to shed warmups and don skis), and assists them to get in the correct position. Sometimes this role is referred to as a 'herder of racers'.

Procedure:

- For interval-start competitions, the Start Controller calls racers in order and presents a line up to the Assistant Starter. As they will be the first to know if a racer is missing or late, they should inform the Assistant Starter of those situations.
- For mass-start competitions, Start Controllers help get racers to the right positions - typically by guiding them to the correct start lane on the grid.
- For sprint heats, this official calls the next four or six racers to the start area at the correct time (scheduled-heat start minus two minutes).

Equipment:

- clipboard, pencils, start list, chevron lane assignments

*Chart Steward**Reports to the Chief of Start*

When flip charts are used for Pursuit-Start competitions, this official marks off the racers as they leave and turns the pages when required.

Equipment:

clipboard, pencils, pursuit-start list for lane

*Start-Time Recorder**Reports to the Chief of Start*

This official records start times in interval- and pursuit-start competitions. If no failures of start-gate equipment are reported, the Start Time Record could be used by the Backup Timing team to record start times in their computer. Otherwise they would not have a start record and their start times would be those on the Start List.

Procedure:

- For interval-start competitions, the Start-Time Recorder uses a timing device, either electronic or a printing timer, to capture and record the actual time a racer leaves the start. This process is a backup if a start gate fails temporarily and can be used to record late starts for review by the Jury. Late starts are the racers responsibility and usually the start time used is that on the start list. However, in the unlikely event a racer can show it was the fault of an official that they were late, the Jury may need to know their actual start time.
- For mass-start competitions the Start-Time Recorder could record the actual start time as this may be different than that scheduled. However typically this process is taken care of by designating one of the Electronic Timers as a start device.
- For pursuit-start competitions, the starts must be monitored, but in this case the Start-Time Recorder is best equipped with a video device in front of the start line to record the start with a view of a double-sided display clock. In this way early starts can be detected and sanctions imposed as per the rules.

Equipment:

- clipboard, pencils, start list (formatted to allow for written start time)

Chief of Primary Timing*Reports to the Chief of Timekeeping, Scoring & Data Processing*

Oversees the following:

- Finish Referee
- Finish-Time Team Leader
- Electronic Technician
- Runners – Primary and Backup Timing

The Chief of Primary Timing is responsible for staffing the lap and finish areas appropriate for the competition format and ensuring all officials are knowledgeable about their individual roles and responsibilities.

Finish Referee

Reports to the Chief of Primary Timing

Oversees the following:

- Bib Recorder
- Video Operator

The Finish Referee is responsible for keeping a list of the order in which the competitors cross the finish line.

Procedure:

- For interval-start competitions, the Finish Referee would position themselves at the finish line and be given a Bib Recorder to work with. Given that typically two timing teams would be deployed at either end of the finish line, this referee can function as a tie breaker in the event the two timing teams have different bib sequences. Bear in mind that for Interval-start races, order of finish is slightly less critical, as racers who finish together did not start together and time counts for everything.
- For mass-start competitions, the Finish Referee's role is more critical than interval-start races. While the task can be done with the naked eye, it frequently needs the support of video recording and any order-of-finish race should be so equipped.
- For pursuit-start competitions, the winners are determined by order of finish just like mass-start events, so the same disciplines should apply.
- For sprint heats, there is an option for the Finish Referee to call the order of finish by lane. In that event they are supported by an official identified as the Lane-Order Recorder. If there is uncertainty, a radio or headset call to the Video Operator is mandatory.

Bib Recorder

Reports to the Finish Referee

The Bib Recorder is responsible for recording the order of bib numbers given by the Finish Referee.

Procedure:

The Bib Recorder works alongside the Finish Referee and records the bib numbers as the Referee dictates.

Equipment:

- clipboard, pencils, Bib order forms

Video Operator

Reports to the Finish Referee

The Video Operator is responsible for recording the order in which racers finish.

Procedure:

Although consumer-class video-enabled tablets could be used, for critical competitions it is much better to use photo-finish technology. In that event, the camera is set up to cover the finish line, but the operator is likely in the timing centre with their own computer.

*Electronic Technician**Reports to the Chief of Primary Timing*

The Electronic Technician is responsible for the preparation, setup, maintenance and repair of the electronic timekeeping equipment and the communication equipment. It may be that this responsibility is split for Timing, Communications and Public Address, according to the skills of those involved.

Duties:

- assist the Chief of Timing, Scoring and Data Processing in the selection/procurement of compatible
- timing /computer systems and equipment;
- assist with the selection of a suitable communication system and equipment;
- obtain or build suitable equipment for timing and the communications systems (e.g. high-gain antennae);
- install wiring and connector systems for timing, communications and public address systems;
- set up and test the timing, communications and public address systems with the responsible Chiefs;
- trouble-shoot and maintain all electronic systems prior to and during the event; and
- assist with the dismantling and storing of all electronic systems after the event.

Procedure:

This volunteer must be a trained electronic technician familiar with timing, radio and public address equipment and operating systems. This person should be recruited well in advance of the actual event to assist in the selection of equipment and any preliminary installations required. New installations may need suitable underground wiring, or connector boxes may need to be designed and built. Immediately prior to the event, the electronic technician assists with installing the various systems and tests them to ensure they all work. When the equipment is functional, he/she remains on call to correct any operational problems which may occur. (Cold, wetness or snow and wind are known to give electronic systems problems).

Equipment:

- tool kit, circuit tester, spare connectors, tape, all electronic timing equipment

*Runners – Primary and Backup Timing**Reports to the Chief of Primary Timing*

Runners are used to transport information from Primary, Backup and Lap Timing teams. Primary and Lap Records go to the Primary Computer Operator and Backup records to the Backup Computer Operator.

Procedure:

The runners must circulate carefully, as directed, between the various locations. They require a knowledge of how the time and results information must flow for any given competition and must be aware of potential dangers such as stepping across the electronic beam or interfering with skiers. They should be prepared to staple records together to represent sets.

Equipment:

- Clipboard, stapler and staples, plastic bag for wet conditions.

*Finish-Time Team Leader**Reports to the Chief of Primary Timing*

Oversees the following:

The Finish-Time Team Leader is responsible for deploying and overseeing the team(s) recording finish times.

- Finish Timer
- Finish Bib Recorder
- Finish Bib Caller
- Lane-Order Recorder
- Lane Bib Caller
- Lane Bib Recorder
- Sprint-Heat Consolidator

Equipment:

- timer batteries, timer printer paper.

*Finish Timer**Reports to the Finish-Time Team Leader*

This official records finish times for all timed race formats.

Procedure:

- Activate the timer (plunger or impulse key) for each racer as their toe hits the finish line when a photobeam is used and attached to their time unit;
- monitor that the signal is being received in case there is a temporary failure of the photobeam;
- inform the Finish-Bib Recorder when two or more skiers only generate a single signal from the photobeam (all timers emit a 'beep' so it is not hard to tell - make sure the operator has adequate hearing!);
- monitor timing unit for low batteries and change them when necessary; and
- if a printing timer is used, monitor and change paper tape as required.

Equipment:

- timer batteries, timer printer paper.

Finish Bib Recorder

Reports to the Finish-Time Team Leader

Procedure:

The Finish Bib Recorder works alongside the Finish Bib Caller and records the bib numbers the Caller announces.

Equipment:

- clipboard, pencils, Bib-Order forms

Finish Bib Caller

Reports to the Finish-Time Team Leader

The Finish Bib Caller announces the bib order of finish.

Procedure:

The Finish Bib Caller works alongside the Finish Bib Recorder to call out the bib order. For races where large groups may finish together, have a smartphone handy with a recording app. It is acceptable to call bib numbers before the racers have crossed the finish line and amend the order after the fact. However, this procedure must be done with care for 'order-of-finish' races. For interval-start races each racer had a different start time so order may not be quite as critical.

Equipment:

- GOOD EYES and the ability to concentrate!
- Smartphone with recording app.

Lane-Order Recorder

Reports to the Finish-Time Team Leader

This official records the call of the Finish Referee when finish order is judged by lane rather than by bib order.

Procedure:

Using the Sprints – Order of Finish by Lane form referred to in Equipment below, the Lane-Order Recorder works alongside the Finish Referee and after each sprint heat, passes the result verbally to the Sprint-Heat Consolidator.

Equipment:

- Clip board, pencils, "Sprints – ORDER OF FINISH BY LANE" forms found at [Appendix 5](#).

Lane Bib Caller

Reports to the Finish-Time Team Leader

This official calls out the bib number in order of finish for their designated lane.

Equipment:

- Concentration!

Lane Bib Recorder

Reports to the Finish-Time Team Leader

This official records the call of the Lane Bib Caller for their lane.

Procedure:

Using the bib-order recording form referred to in Equipment below, the Lane Bib Recorder works alongside the Lane Bib Caller and after each sprint heat passes the result verbally to the Consolidator.

Equipment:

- Clip board, pencils, "Sprints – BIB ORDER OF FINISH IN LANE" forms found at [Appendix 5](#).

Sprint-Heat Consolidator

Reports to the Finish-Time Team Leader

This official takes the information of finish-order-by-lane and then adds the bib-order-by-lane for each sprint heat.

Procedure:

Using the consolidated lane and bib order form referred to in Equipment below, the Consolidator takes the finish-order-by-lane and records it. They then complete the record by getting the bib-order-in-lane information. That information is passed by radio or headset to the Computer Operator who will confirm the order with the Jury in case the order is revised due to an infraction.

Equipment:

- Radio/Headset, Clip board, pencils, "Sprints – Consolidated Lane & Bib Order" forms found at [Appendix 5](#).

Chief of Backup Timing

Reports to the Chief of Timekeeping, Scoring & Data Processing

Oversees the following:

- Timer Operator
- Computer Operator
- Lap-Time Team

The Chief of Backup Timing is responsible for supervising the officials working as a Backup Timing crew recording and calculating of skiers' times to provide a complete set up backup results. The function of individual officials within the team is the same as for Primary Timing.

Timer Operator – Printing Timer

Reports to the Chief of Backup Timing

In the event the backup timing device is a printing timer, the operating procedure is somewhat different than an Electronic Wireless Timer. However, the task is the same regardless of technology in that the operator captures the time each skier crosses the finish line.

Procedure:

Backup Timers using a printing timer do not have to relay the captured time since the timer unit prints the time, with a sequence number, on a tape. The Timer Operator should read the timer display and call the time to the Finish Bib Recorder if there is enough time between skiers. This enables the Bib Record and Timer tape to be synchronized. Once several times have been captured (8 to 12) the tape should be rapidly advanced, torn off, and passed to the Finish Bib Recorder for attachment to the Finish Time Record form. ([Appendix 5](#)). A matching numeral should be written on each of the tape and Finish Record Form.

Equipment:

- printing timers - one per timer plus one spare

*Computer Operator**Reports to the Chief of Backup Timing*

The computer operator is responsible for entering times from Backup Timing if printing timers are used.

Procedure:

During or after the draw meeting, the race management database is backed up and then copied onto the backup timing computer. During the race the operator enters the time data for each skier as it becomes available and prints out race results once all the required data has been entered. NOTE: care must be taken to ensure that Backup results are only provided to the Chief of Timing, Scoring and Data Processing through the Chief of Backup Timing, and are not made generally public.

Equipment:

- Personal computer with race management software, a printer, printer paper, and a warm location in which to work

Lap Timing

If a competition is located in a stadium where the skier by-passes the finish line on a “thru” lane and where lap times are to be recorded by an additional timing team, times are recorded using the same technique as used by a finish team. A Lap Timer, Bib Caller and Bib Recorder are required.

Announcer*Reports to the Chief of Timekeeping, Scoring & Data Processing*

Oversees the Announcer’s Assistant(s)

The Announcer is responsible for providing a continuous supply of information to the public, coaches, and skiers at the race site by means of a public address system. Announcers should be encouraged to describe the action, but ensure the results come from the officials in any close finish. The Announcer is often the MC for the banquet or reception.

Duties:

Duties will vary considerably with respect to the level of the competition, as will the hardware used. For local/club events a strong “one man show” and a good megaphone may be sufficient. For major events, the role of the Announcer almost becomes that of a performer, and with his/her talents, the Announcer

must capture the drama and excitement of the competition through continuous commentary. They are expected to be bilingual for national-level events. The Announcer's booth or platform is set up in the stadium area to provide a commanding view of all start and finish activities.

It is extremely important for the announcing crew to synchronize with 'Race Time'.

Pre-Competition Information for the Announcers to broadcast:

- weather conditions, temperature, wind, etc.;
- countdown to start: 15-minute, 10-minute, and 5-minute warnings then maintain silence for at least one minute before races are scheduled to start to avoid interfering with communication between timekeeping officials; and
- bulletins to skiers to go to ski marking area, etc.

Between the above announcements, the Announcer develops spectator interest via general information on the following:

- competitor profiles;
- sponsor acknowledgements;
- visiting dignitaries; and
- location of services and facilities.

Music is an excellent means of creating an exciting atmosphere. The Announcer should co-ordinate music selection and presentation.

During Competition:

The Announcer is striving to maintain spectator interest by continually supplying the crowd with stimulating commentary of a play-by-play nature. The Announcer may:

- introduce each skier entering the start gate – the pronunciation of names should be correct, and information should include basic facts such as age, hometown, club/division affiliation, past performances of note;
- adapt skier introductions to suit different start methods (pursuit, relay and mass starts);
- maintain complete silence at the time of the actual start of a mass-start event;
- read out the lap times of skiers passing through the stadium or out on course, and make predictions of their unofficial ranking;
- report on the special status of any skiers, start times or injuries;
- report on skiers who did not finish;
- make warning announcements following events and start times;
- acknowledge sponsors;
- announce unofficial results – reminding the audience that times are “unofficial”; and
- announce the time and location of the awards presentation.

Announcers should concentrate on building excitement around the suspected leaders in the competition. How close are the competitors to each other? Is this a qualifying event for the Provincial Team, National Championships, the Olympics? Where possible, the announcing team should be given a view of the race management system reports while the race is in progress. By viewing the results monitor they can call unofficial results as seen by the timekeeping team. A remote monitor on the results computer is one approach, or a separate computer networked to the results system represents the other. However, the announcer should be wary of announcing winners of gold, silver and bronze, but rather should announce finish order since some racers may not be eligible for medals.

Post Competition:

- congratulate winners and all competitors, officials, coaches, sponsors, organizers; and
- announce medal winners at on-site awards presentations.

Equipment:

- public address system, radio, wired or wireless mike (a mike stand will free hands), clipboards, pencils, start list, racer profiles if available

Announcer's Assistant(s)

Reports to the Announcer

The Announcer's Assistant can have two roles. The first is to feed racer information to the Announcer. He/she "trades-off" commentary with the Announcer regarding racers and their progress to maintain continuity. The second role is required if the sight lines into the stadium are limited and the Assistant acts as a pre-caller so the announcer can identify racers as they enter the stadium.

Duties:

- receive reports from the intermediate timing and any other prearranged timing stations set up on the course;
- receive reports from the stadium and timing centre;
- handle incoming and outgoing messages;
- spot incoming skier bib numbers; and
- supply unofficial finish results using a PC networked to the race management PC.

Equipment:

- binoculars, pencil, pad of paper, radio, headset to pre-caller

Awards Results Compiler

Reports to the Chief of Timekeeping, Scoring & Data Processing

The Awards Results Compiler is responsible for gathering and distributing official results information on competitors receiving awards. Should one official not be given this job it must be assigned to some other official in the results or announcing group of officials to ensure that the required information is prepared as the competition progresses and is ready as soon as the last race ends.

Duties:

- gather information about which awards will be presented;

- obtain a 'Top 5' results report from the race management system or Competition Secretary and forward it to the Announcing Co-ordinator or Announcer and the awards presenters; and
- co-ordinate the presentation activities with the presenters and the Announcing Co-ordinator as required.

SECTION 15: COMPETITION SECURITY

Security Organization & Practice

Competition Security is responsible for controlling the access of all personnel to the stadium area and on course. In large events, this may be extended to include the entire race site. The access control ensures that the integrity of the field of play is maintained and that a free flow of spectators and athletes around the stadium and course occurs. The enjoyment of the race is thereby enhanced for athletes, officials and spectators alike. In low-level regional and club events, security may be a minor problem and is managed by the Chief of Course and the Chief of Stadium. In larger, high-level events where international racers are competing, spectator and media interests are high which makes security a concern. Such an event requires a large number of volunteers (marshals) to maintain control. This creates a need for a Chief of Competition Security and a specific structured committee to provide the security required.

Chief of Competition Security

Reports to the Chief of Competition

Oversees the following:

- Chief of Course Marshals
- Chief of Stadium Marshals
- Manager of Team Rooms
- Manager of On-Course Transportation

The Chief of Competition Security is responsible for providing the necessary controls to allow the spectators and media to circulate freely without interfering with race officials, skiers and coaches.

Equipment:

- armbands or uniforms, radio, course and stadium maps, cellular telephone

Procedure:

The Chief of Competition Security is normally required only at large, high-level competitions. For such events, a system of "accreditation" is devised by the Event Organizing Committee so that any person on the race site, except the general public, is given an identification tag which indicates by code where they are permitted access. The Chief of Competition Security is responsible for providing Stadium and Course Marshals at the various control gates and viewing areas. Close liaison with the Chief of Competition, the Chiefs of Course and Stadium, the Event Chairperson and Venue Management is necessary. The Chief of Competition Security may also have to liaise with the local police force to arrange for some assistance, (especially with the general public who may not wish to abide by the security provided by the Competition Committee), or to provide security for high-profile guests.

At all levels of competition some degree of control must be organized to direct the movement of people in the following areas:

- stadium
- start and finish
- racecourse and warm-up
- waxing facilities

- race officials building
- parking area

Security in these areas should control not only access, but also provide continued surveillance with a concern for theft and vandalism where it is appropriate. However, while maintaining effective controls, it is important to promote a pleasant and friendly atmosphere.

Chief of Course Marshals

Reports to the Chief of Competition Security in major events

Reports to the Chief of Course in lower-level events

Oversees the Course Marshals

The Chief of Course Marshals is responsible for supervising the access of spectators, officials and non-competing skiers on the course. They can also direct traffic with respect to coaches and wax testers, to course closures, to direction of travel (skiing) on the course, etc.

Marshals maintain the integrity of the field of play!

Procedure:

The Chief of Course Marshals plans and assigns Course Marshal locations in order to supervise course crossings, competitor access to trails, non-competitors skiing on course, etc. It is important to move around the course, keeping in radio contact with course marshals to locate any areas requiring additional control. This official should have a friendly but firm disposition.

Equipment:

- radio, course maps, light touring or racing ski equipment

Course Marshals

Report to the Chief of Course Marshals in major events

Report to the Chief of Course in lower-level events

Course Marshals are responsible for supervising controlled access areas and surveillance as directed by the Chief of Course Marshals.

Procedure:

Course Marshals are required to check appropriate forms of identification, such as arm bands, racing (training) and coaches bibs, and accreditation tags to determine if an individual is authorized to be on course. Course marshals supervise all course crossings to control racer/pedestrian traffic and to ensure that the track quality is maintained.

A marshal's function is one of control. They should not be threatening or aggressive in dealing with the public and skiers. They should be knowledgeable of race regulations and familiar with the course in order that the restrictions can be explained, and assistance given in a professional and diplomatic manner. Every effort should be made to maintain an enjoyable atmosphere on the course.

Equipment:

- armbands or identifiable clothing, radio (key areas), course map, warm footwear

People skills are important!

Chief of Stadium Marshals

Reports to the Chief of Competition Security in major events

Reports to the Chief of Stadium in lower-level events

Oversees the Stadium Marshals

The Chief of Stadium Marshals is responsible for supervising all access points for spectators, media, volunteers and athletes into the stadium area.

Procedure:

This official plans and assigns Stadium Marshal locations in order to supervise access to the stadium, press corral, traffic and parking areas, and ski waxing and team room areas. They are also to carry out surveillance against theft and vandalism. In addition, Stadium Marshals may be assigned to direct spectators to viewing areas. The Chief of Stadium Marshals moves around the stadium area monitoring stadium security during the competition. This official should have a friendly but firm disposition.

Equipment:

- radio, stadium map, start list.

Stadium Marshals

Report to the Chief of Stadium Marshals in major events

Report to the Chief of Stadium in minor events

Stadium Marshals are responsible for providing controlled access and surveillance as directed by the Chief of Stadium Marshals.

Procedure:

Stadium Marshals' duties fall into three basic categories:

- access control for spectators, officials, and skiers;
- general surveillance; and
- parking or traffic control.

All are related in that they seek to ensure a controlled environment to maintain security and protect the field of play.

Stadium Marshals are required to check appropriate forms of identification to determine whether an individual has the authority to enter any restricted areas. This may involve asking to see accreditation tags, racing (training) or coaches bibs, or armbands depending on what is being used.

Marshals should not have to be threatening or aggressive in their manner of dealing with the public and racers. They should be capable of explaining why the restrictions are necessary so that those confronted can accept them. Every effort should be made to maintain an enjoyable atmosphere in the stadium area.

Equipment:

- armbands or identifiable clothing, stadium map

*Manager of On-course Transportation
Reports to the Chief of Competition Security*

Oversees the Drivers

The Manager of On-Course Transportation schedules and manages on-course transportation of officials, VIPs, media, and equipment transport using snowmobiles and/or all terrain vehicles. This official ensures that all vehicles are regularly serviced and operational, and that all drivers are familiar with the vehicles and course access rules.

Duties:

- consult with the Chief of Course and the Chief of Stadium regarding transportation needs and corridors for training and competition day(s);
- train and/or check drivers to ensure they have suitable driving skills;
- familiarize drivers with on-course etiquette;
- check all drivers to ensure they meet any area safety and licensing requirements for snowmobiles and ATVS;
- dispatch drivers and suitable vehicles to transport officials, press, supplies, etc. on race day as required; and
- ensure that vehicles are maintained and ready for operation as required.

Equipment:

- long-track snowmobile(s), four-wheel drive ATVs, snowmobile sled(s), radio, dispatch centre, course and stadium maps.

Drivers

Report to the Manager of On-Course Transportation

Drivers transport people and/or equipment via snowmobiles and/or ATVs to required locations on course.

Procedure:

Drivers provide on-course transportation by driving suitable snow vehicles as requested. Attention to safety and awareness of approved routes are of the utmost importance. All driving routes must be cleared with the Chief of Course.

Equipment:

- snowmobile suit or extra warm clothing, felt lined boots, radio, course map

Manager of Team Rooms (Waxing Area)
Reports to the Chief of Competition Security

The Manager of Team Rooms is responsible for the organization and maintenance of team rooms.

Duties:

- assign waxing rooms or area to each team in consultation with the Chief of Competition, make a list of assignments and give a copy of the list to the competition office;
- distribute room keys to the team manager or coach and have keys signed for at the Competition Office;
- check rooms and toilets to ensure that all utilities are working;
- be on site during scheduled training hours, and from two hours before to one hour after a competition;
- monitor flow of people in area;
- watch for vandalism and theft, especially during training and competition times; and
- ensure that security surveillance is provided day and night.

Procedure:

The Manager of Team Rooms maintains a list of racing teams, the team leaders, and their assigned team rooms. He/she distributes keys or is available to open team rooms as required. The team rooms are checked regularly to ensure cleanliness and security. If teams are to be given supplies, these are to be distributed equitably to each team room on a regular basis.

Waxing facility details: See [Section 9 - Ski Preparation Waxing and Warmup Areas](#).

Equipment:

- team room supplies e.g. soft drinks, water, chocolate bars, etc.; team room keys and master set; broom(s) and dustpan(s); flashlight; team leader name list; fire extinguisher for each room; signs and flags

SECTION 16: SAFETY, MEDICAL SERVICES AND DOPING CONTROL

Introduction

The responsibility for first aid and medical services vary with the level of the competition. For all events, someone must be designated as Chief of Medical Services. They are responsible for providing services to everyone on site including athletes, coaches, officials and spectators. This person would report to the Chief of Competition who may then delegate the reporting to the Chief of Course or other official.

Of note:

- air temperature and weather conditions have a potential for causing frost bite, hypothermia, etc.;
- remote areas on the course can make treatment and evacuation difficult;
- speed of the skiers is increasing the potential for injury in the event of an accident; and
- insurance coverage and organizer liability are of concern.

Competition Safety

Competition safety is best achieved by good planning, preparation and operation. By far the most effective way to ensure competition safety is to engage the Canadian Ski Patrol. They have the training, expertise and equipment to provide an excellent solution for first aid and victim evacuation. It is recommended they be engaged early in the planning so that it can be established which areas of safety they can take on and where they will need assistance from other resources.

Planning

- evaluate courses in advance and remove/avoid hazards; and
- design cut-offs for long races as in Loppets, so that injured competitors can be accessed and treated or transported to hospital quickly.

Preparation

- have well-ventilated waxing areas (see [Section 9](#));
- ensure there are fire extinguishers in all waxing areas;
- erect safety fences and pads around potential hazards;
- mark racecourses well;
- have a warm, well equipped and staffed medical centre as close to the stadium area as possible;
- have the venue well marked and prepared, especially in high-traffic areas such as parking lots, stairs, and washrooms; and
- be prepared to deal with wet, slippery areas dangerous for those wearing ski boots (have mops, mats ice melt or ice chippers, etc.)

Operation

- have first-aid attendants on course and at the finish area during the whole competition, including on training days; and
- have well-located refreshment or feeding stations with warm drinks, food and support services where appropriate.

Chief of Medical Services

Reports to the Chief of Competition

Oversees the following:

- Clinic Staff
- First Aid Attendants

The Chief of Medical Services is responsible for co-ordinating all first aid and medical treatment required by the competitors, volunteers and general public attending the competition and managing the Medical Centre. This official must have first-aid training. Close work with the Chief of Competition and Chief of Course is required. Many doctors will maintain that good first aid properly applied is the best that anyone can do anyway until the injured person is transported to a hospital.

Procedure:

- decide the location and deployment of first-aid attendants on the course in consultation with the Chief of Course; and
- supervise and provide direction and training to the first-aid personnel

All on-course movement and positioning of First Aid Volunteers is under the direction of the Chief of Course

Equipment:

- minimum of one AED, with two preferred (if you use one or its battery dies you need a backup);
- oxygen
- spinal board
- trauma kit
- designated snowmobile and toboggan with a driver who knows the trails
- mobile first-aid kits
- radios
- cell phone to call ambulance if necessary.

Clinic Staff

Reports to the Chief of Medical Services

These trained nursing staff or first-aid attendants are required to supply first-aid care as directed by the Chief of Medical Services.

Procedure:

The clinic staff should be qualified to give emergency first aid and preferably have experience in treating hypothermia, exhaustion, frostbite, dehydration and injured morale. At least one first-aid provider should be at the finish line when races are on.

Equipment:

- a warm first-aid room with bed (preferably) indoors, or if this is impractical consider using a motorhome
- minimum of one AED, with two preferred (if you use one or its battery dies you need a backup)
- oxygen
- first-aid supplies
- stretchers
- blankets
- radio

First-Aid Attendants*Reports to the Chief of Medical Services*

First-Aid Attendants and the first-aid staff are required to supply first-aid care to competitors and officials, and to evacuate skiers to the medical centre if required. First aid applied quickly and professionally can minimize personal injury and reduce any potential liability that might arise. First-Aid Attendants are normally posted on the racecourse at potentially hazardous locations; or at a convenient intersection on the course that allows quick access to several areas of the course; and at the finish and lap areas in the stadium. They should be familiar with the entire trail network and have a course map so they can reach an injured skier as quickly as possible. On very cold or windy days, they must be prepared to deal with frost bite and hypothermic cases as well.

By far the most effective way to ensure competition safety is to engage the Canadian Ski Patrol. They have the training, expertise and equipment to provide an excellent solution for first aid and victim evacuation. It is recommended they be engaged early in the planning so that it can be established which areas of safety they can take on and where they will need assistance from other resources.

Procedure:

- Deploy fully equipped to the course and stadium as directed;
- provide first-aid or carryout an evacuation as required; and
- fill in a medical report and provide a copy to the competition race office.

Equipment:

- Each on-course attendant carries a backpack supplied with a first-aid kit, blankets, warm drinks, triangular bandages, small splint set, radio, course maps and accident report forms and pens.
- In addition, a rescue toboggan equipped with extra blankets and long splints is to be located at a convenient intersection on course.

Concussion

Incidents involving significant trauma are rare in our sport, but first-aid providers must be aware of the potential for concussion. If concussion is suspected, it is important to escort the athlete to their coach, tell the coach a concussion may have occurred and draw their attention to prevailing concussion protocols. Most Nordiq Canada Divisions have such protocols in place. The [“Making Headway” e-learning](#)

[module](#) provided by the Coaching Association of Canada (CAC) is the standard reference for coaches on concussions and can be accessed free of charge in the CAC Locker.

Doping Control

Doping Control is a procedure for checking athletes for drug use and is sometimes required at regional and national championships and international competitions. The tests are managed and carried out by The Canadian Centre for Ethics in Sport (CCES). The CCES assigns a Doping Control Officer (DCO) to the competition site. The Chief of Competition and/or the Event Organizing Chair will be informed ahead of time of CCES's intention to conduct testing at an event. The requirements are somewhat onerous but essential if a fair playing field is to be maintained. The general procedures are explained on the CCES web site (<https://www.cces.ca/sample-collection-procedures>).

The Doping Control Station should be located in close proximity (within walking distance) to the competition site. The Doping Control Station should be set aside from the general traffic flow to assist security and be clearly marked with signs. It should be in a heated building with three rooms: the waiting room with seating capacity of at least 20 and with a table, a working room large enough for three people, storage equipment, a lockable fridge, table and chairs; and a lavatory, equipped with a toilet and sink, that is large enough for the athlete and a witness. On many occasions CCES have assisted in this process by using a motor home.

The DCO brings all of the required sampling equipment to the competition site, and the Competition Committee should supply: individually-sealed (and unbroken), non-alcoholic, and non-caffeinated drinks; cups; snacks in sealed containers; paper towels; toilet paper; name tags/arm bands for volunteers; clipboards; pens and pencils.

Chief of Doping Control

Reports to the Chief of Medical Services

Liaises with Chief of Competition / Technical Delegate

Oversees the:

- Stewards
- Registrar
- Testing Station Assistants

The Chief of Doping Control is responsible for liaising between the Competition Committee, Nordiq Canada and the Certified Doping Control Officer.

Duties:

- liaise with the Nordiq Canada office, the TD and DCO;
- work with the CCES and the DCO to organize and set up the drug testing station;
- recruit, assign and train volunteers as stewards (six), registrar (one), testing station assistants (two);
- explain doping control procedures at the Team Coaches' Meeting prior to the race;
- select and identify, with the TD, the athletes to be sampled and assign the steward to the athlete (normally the first four skiers plus two random skiers are selected);

- notify selected skiers when they finish the race by accompanying the assigned steward. Each skier has an escort (male for men and female for women);
- ensure that skiers are escorted to the testing station when ready or when scheduled; and
- assist with security control at the testing station after all racers are notified.

Stewards

Reports to the Chief of Doping Control and DCO

Stewards are responsible to notify skiers of selection for doping control immediately after the racer crosses the finish line.

Duties:

- notify the skier of his selection immediately after he crosses the finish line and present the skier with an official notification form;
- escort the skier during warm-down, to the Doping Control Station, and to award presentations, if necessary. Warn the skier that he/she must not leave the sight of the Steward, or the skier may be deemed guilty of a doping infraction, with subsequent penalties;
- ensure that the skier does not drink or ingest anything other than the beverages provided from the doping control area (since they are sealed at the time of being given to the skier); and
- assist the DCO with administration of the samples if required.

Equipment:

- clipboard, pen/pencil, appropriate notification forms

Procedure for escorting skiers to doping control:

Stewards are called “Marshals” by the CCES. Each steward is assigned to one selected skier. When the selected skier crosses the finish line, the steward presents him with an official “Canadian Centre for Ethics in Sport” notification form and witnesses the skier signing the form. He/she must then initial the signature and record the time of notification on the form. The skier has 1/2 hour to report to the Doping Control Station. The Steward must remain with the athlete from the time he/she crosses the finish line until he/she is signed into the Doping Control Station. During this time, the athlete is not permitted to eat, drink (except a beverage in a sealed bottle given to the skier by the Steward of Doping Control staff) or use the washroom. It is preferred that Stewards be competent skiers and of the same sex as the skier he/she is escorting.

Registrar

Reports to the Chief of Doping Control and DCO

The Registrar is responsible for signing people in and out of the Doping Control Station.

Duties:

- crosscheck the identities of skiers;
- control access to the doping control station to allow doping control officials, selected athletes, and one team official only; and
- assist the DCO with administration of the samples if required.

Procedure:

When the athlete arrives at the doping control station, the registrar verifies the identity of the skier by crosschecking his notification form and his bib number. As the competition progresses, security may become a problem and an unassigned steward, or the Chief of Doping Control, should assist in managing the situation.

Equipment:

- clipboards, pens, appropriate forms

Assistants:

Report to the Chief of Doping Control and DCO

Assistants in Doping Control witness the passing of the samples and ensure that there are no irregularities in that process. Male observers are paired with male athletes and female with female. Stewards may assist with this job.

SECTION 17: COMMUNICATIONS

The Requirement

Accurate communication among officials is essential to running a safe and effective competition and radios are most commonly used. To be effective across the typical cross country ski site, radios need to be of at least 5-watt power. VHF/UHF radios with multiple channels can be obtained for well less than \$100.

This section will outline the deployment of radios for a simple, low-key race and a complex, high-end race. It will also introduce the topic of using Wi Fi with tablet or smart phones to manage a race.

Major Race

Using a multi-channel radio communication can be segregated and streamlined to purpose:

<u>User:</u>	<u>Initial Channel:</u>
Chief of Competition	Jury
Technical Delegate	Jury
Assistant Technical Delegate	Jury
Race Director	Jury
Chief of Competition Control	Jury
Chief of Timing, Scoring & Data Processing	Timing
Chief of Primary Timing	Timing
Chief of Backup Timing	Timing
Computer Operator(s)	Timing
Chief of Start	Timing
Finish-Line Team Leader	Timing
Lap-Time Team Leader	Timing
Chief of Course	Race
Chief of Medical Services	Race
Race Office	Race
Chief of Stadium	Race
Announcer	Race
Awards Co-ordinator	Race
Apprentice TD (if assigned)	Jury
Secretary to the Jury	Jury

Low-key race

<u>User:</u>	<u>Channel:</u>	<u>Purpose:</u>
Chief of Competition	Race	Communicate with all major officials/functions
Technical Delegate members	Race	Communicate with Chief of Comp and other Jury members
Chief of Timing, Scoring & Data Lap crews	Race	Communicate with Chief of Comp, Start, Finish and Lap crews
Competition Secretary (DNS)	Race	Update any issues with competitors e.g. scratches
Jury member(s) members	Race	Communicate with Chief of Comp and other Jury members
Chief of Course members	Race	Communicate with Chief of Comp and other Jury members
Medical services	Race	Be alerted to any situations requiring their attention
Course Controllers	Race	Communicate with Chief of Course
Start Line	Race	Communicate with Chief of Timing, Scoring & Data
Lap Lane	Race	Communicate with Chief of Timing, Scoring & Data
Finish Line	Race	Communicate with Chief of Timing, Scoring & Data

Radio discipline must be established, and officials trained. A caller should identify themselves and the person or position they are trying to raise. It is acceptable to repeat to wake folks up, e.g., “Chief of Course calling Chief of Stadium, Chief of Course to Chief of Stadium. Come in”. Allow 20 seconds for the radio to be retrieved from inside outdoor clothing. Call again if no answer. If the conversation needs more than 20 seconds of questioning with a straight answer, request switching to a different, previously-agreed-upon channel for a lengthy discussion. This keeps ‘race radio’ open for other urgent discussions.

Radio Allocation, Distribution and Retrieval

This needs a plan and a list. Radios can be distributed from the competition office and must be actively retrieved after the races so they can be recharged for the next day.

Potential for Newer Technologies

If the race site can be covered by a Wi-Fi network, there are several tools available of particular benefit to the Jury and Competition Control. With smart phones or tablets groups can be set up so that they can exchange messages including video images. Apps like WhatsApp are current examples (2019) of such useful methods. WhatsApp allows the creation of chat groups made of up a specific membership to serve the Jury, Timing, Controllers etc. The text part could supplant radio or headset use for Timing and Scoring. Exchanging text, voice and video could be of great value to Juries. Do bear in mind that smart phones may not be the best devices to use outside in the cold

APPENDIX 1 – EQUIPMENT LISTS

The following List of Equipment is provided as a guide. The number and type of items needed will vary significantly with the size and level of the event.

Course Equipment	Source	Quantity	Acquired
Course Length Signs			
Course Distance Signs			
Course Direction Signs			
Spectator Signs			
Portable Radios			
Clip Boards, Paper & Pencils			
Pocket Knife			
Standing Footpads			
Permanent Fencing			
Snow Fencing			
Pop Fencing			
4-Inch Wide Ribbon			
Course-Marking Coloured Flags			
Post Padding			
Track Setter			
Snowmobile – 2-Track or Long-Track			
Grooming Equipment - Compactor or Roller			
- Powder Maker			
- Scarifier or Renovator			
- Compactor Drag			
Sled			
Transportation Toboggan			
Snow Cat Vehicle - "U" blade			
Renovator			
Power Tiller			
Compactor Bar			
Rakes 1 metre wide			
Garden Rakes			
Snow Scoops			
Snow Shovels			
Square Shovels			
Rope 5/16"-3/8" in Diameter			
Axes			
Bow Saw			
Racing or Light-touring Skis			
Forerunner and Course-Closer Bibs			
Folding Tables			
Bottles for Refreshments			
20-litre Thermos Jugs			
Propane Stove			
20-litre Pot with Lid			
Garbage Bags			
Rechargeable Electric Drill with Batteries & Snow-twist Drill Bit			
Backpacks			
Blankets			
Thermometers for temperature stations			

Stadium Equipment

	Source	Quantity	Acquired
Tents for Waxing and Volunteer Shelters			
Timing Shelter			
Generator			
Industrial Space Heaters			
Fire Extinguisher			
Course-Direction Signs			
Information Signs			
Start & Finish Banners and Posts			
Relay/Mass-Start Lane Numbers & Flags			
Movable, Stand-alone Fencing			
Pop Fencing			
Snow Fencing			
V-Boards			
Course Flagging (Colours)			
Flags - City, District, National. International			
Snow marking food dye (Kool-Aid)			
Paper towels or facial tissue			
First-Aid Centre & Equipment - Bed/Stretcher			
First-Aid Kits - Portable for On Course			
Storage Rail /Storage Shelves for Racers' Clothing			
Thermometer (in Degrees Celsius)			
Wind Meter For Speed & Direction)			
Portable Radios			
Clipboards, Pencils & Paper			
Stop-Watch			
Official Notice Board			
Results Board			
Manual Score Board			
Weather Board			
Armbands			
Pocket Knife			
Standing Pads			
Square, Chisels,10-Metre Measuring Tape			
Mechanic Tools – Open-end/Box-end Set(s), Socket Sets			
Screwdriver Sets - Straight, Square & Phillips Ends			
Rechargeable Drill & Batteries			
Post Snow Drill			
Measuring Tape – 100-metre			
Rakes 1-metre Wide			
Garden Rakes			
Snow Shovels			
Square Shovels			
Rope 5/16"-3/8" in Diameter			
Sledgehammer			
Podium – 3-Level Awards Type			
Garbage Bags			
Folding Tables			
Blankets			
Carpet for Skiathlon Exchange Boxes			

Timekeeping Equipment

	Source	Quantity	Acquired
Printing Timers			
Portable Radios			
Clipboards, Pencils & Paper			
Voice Recorder(s)			
Stapler			
Standing Footpads			
Officials List			
Electronic Timing Units			
Start Gate			
Finish Beam			
Grip switches			
Cables			
Start Gun/Horn			
PCs for Timing			
PC for Announcers			
Laser Printer(s)			
Inkjet Printer(s)			
Public Address System			
Cordless Microphone			
Speakers & Stands			
CD/Tape Player/MP3 for anthems etc.			
Starting Clock(s)			
Loudhailer (Pre-caller)			
Binoculars			
False-Start Control Flags (Red)			
Flags for Relay Assistant Starters (Green)			
Headsets			
Plastic Covers for Information Boards, Display Clocks etc.			
Garbage Bags			
Folding Tables			
Video Camera(s)			
Photo-Finish Equipment			

Competition Office Equipment

	Source	Quantity	Acquired
Telephones (Landlines)			
Cellular Telephone			
Portable Radios			
Clipboards, Paper & Pencils			
Garbage Bags			
Folding Tables			
Officials List			
Photocopier			
Paper for Photocopier (Coloured for Different Days & Various Forms)			
Toner for Photocopier			
Computer			
Computer Printer			
Paper for Printer			
Post-It-Notes			
Pencils "H" or "F"			
Pencil Sharpener			
Eraser			
Ballpoint Pens			
Permanent Markers (Various Colours)			
Highlighter Pens			
Scotch Tape			
Masking Tape			
Three Hole Punch			
Overhead Projector (or PC Projector)			
Projector Screen			
Flip Chart			
Filing Container			
Mailbox or Message Pick-up System			
Thumb Tacks			
Paper Clips			
Glue Stick			
Three Ring Binder			
File Folders			
Small Note or Message Pads			
Rules & Regulations Binder			
Stapler			
Staples			
Heavy duty staple gun			
Staples for staple gun			
Scissors			
Elastic Bands			
Envelopes			
Letter Size			
Large Brown			
Phone/email contact list: Race Personnel, Media, Emergency			

APPENDIX 2 – OFFICIALS LISTS

Chiefs Committee

Name of Competition _____ Competition Dates _____

	Name of Official	Phone/Email
Chief of Competition	_____	_____
Chief of Competition Control	_____	_____
Chief of Course	_____	_____
Chief of Stadium	_____	_____
Chief of Timekeeping	_____	_____
Competition Secretary	_____	_____
Technical Delegate	_____	_____
Race Director	_____	_____
Assistant TD	_____	_____

Chief of Competition Control	_____	_____
Controller(s)	_____	_____
	_____	_____
	_____	_____
	_____	_____
	_____	_____
	_____	_____
	_____	_____

Course Officials

	Name of Official	Phone/Email
Chief of Course	_____	_____
Chief of Mechanical Grooming	_____	_____
Machine operators	_____	_____
	_____	_____
Chief of Manual Grooming	_____	_____
Manual Grooming/Marking Crew	_____	_____
	_____	_____
	_____	_____
* Chief of Course Marshals	_____	_____
* Marshals	_____	_____
	_____	_____
	_____	_____
Chief of Forerunners	_____	_____
Forerunners	_____	_____
	_____	_____
	_____	_____
Course Closers	_____	_____
	_____	_____
Chief of Temperature Stations	_____	_____
Temperature Recorders	_____	_____
	_____	_____
	_____	_____
First-Aid Co-ordinator	_____	_____
First-Aid Attendants	_____	_____
	_____	_____
	_____	_____
Assistant Chief of Refreshments	_____	_____
Pourers and Servers	_____	_____
	_____	_____
	_____	_____
	_____	_____

* May report to Chief of Competition Security

Competition Secretary Officials

	Name of Official	Phone/Email
Competition Secretary	_____	_____
Recording Secretary	_____	_____
Secretary to the Jury	_____	_____
Competition Office Manager	_____	_____
Bib Pullers/Draw Assistants	_____	_____
	_____	_____
	_____	_____
	_____	_____
Results Poster	_____	_____
Awards Co-ordinator	_____	_____

Stadium Officials

	Name of Official	Phone/Email
Chief of Stadium	_____	_____
Chief of Stadium Preparation	_____	_____
Chief of Competition Equipment	_____	_____
Setup Crew	_____	_____
	_____	_____
	_____	_____
Chief of Refreshment Stations	_____	_____
Servers	_____	_____
Drink Pourers	_____	_____
	_____	_____
Chief of Finish Line	_____	_____
Finish Line Stewards	_____	_____
	_____	_____
Clothing Stewards	_____	_____
	_____	_____
	_____	_____
Chief of Clothing & Equipment	_____	_____
Clothing & Equipment Checkers	_____	_____
	_____	_____
Chief of Relay Exchange	_____	_____
Exchange Controller(s)	_____	_____
	_____	_____
Exchange Referee(s)	_____	_____
	_____	_____
Pre-caller	_____	_____

Timekeeping, Scoring & Data Processing Officials

	Name of Official	Phone/Email
Chief of Timekeeping, Scoring & Data Processing	_____	_____
Chief of Primary Timing	_____	_____
Computer Operator	_____	_____
Electronic Timing Operator	_____	_____
Chief of Start	_____	_____
Starter	_____	_____
Assistant Starter(s)	_____	_____
Start Controller(s)	_____	_____
Chart Stewards	_____	_____
	_____	_____
Lap Time Team	_____	_____
	_____	_____
	_____	_____
Finish Referee	_____	_____
Finish-Bib Recorder	_____	_____
Bib Caller	_____	_____
Finish-Lane Recorder	_____	_____
	_____	_____
	_____	_____
Video Operator	_____	_____
Electronic Technician	_____	_____
Photo-Finish Operator	_____	_____
	_____	_____
Sprint Finish-Lane Recorder	_____	_____

Timekeeping, Scoring & Data Processing Officials (Cont.)

	Name of Official	Phone/Email
Sprint Finish bib callers	_____	_____
Sprint Finish-Bib Recorders	_____	_____
	_____	_____
	_____	_____
	_____	_____
Sprint Results Consolidator	_____	_____
	_____	_____
Chief of Backup Timing	_____	_____
Start Time Recorder	_____	_____
Finish Time Recorders	_____	_____
Bib Caller	_____	_____
Bib Recorder	_____	_____
Runner(s)	_____	_____
	_____	_____
Computer Operator	_____	_____
	_____	_____
	_____	_____
Announcer	_____	_____
Announcers Assistant(s)	_____	_____
	_____	_____
	_____	_____
Awards Results Compiler	_____	_____
	_____	_____
	_____	_____
	_____	_____

Chief of Course – Race Day

Planning & Check List

EVENT		DAY & DATE
DISTANCES		START TIME
TECHNIQUE		METHOD OF START & INTERVAL
Courses to be used		Grooming and Track setting Requirements
1		
2		
3		
4		
5		
6		
Course marking and control		
Course	Task	Person Responsible
	Signage and distance-marking placement	
	Signage and marking relocation and removal	
	Equipment transportation	
	Checking of signage and security	
	Assignment and co-ordination of marshals (Chief of Marshals)	
Feeding Station Tasks		
Time	Task	Person Responsible
	Grooming and track preparation	
	Equipment transportation and setup	
	Officials deployment	
NOTES		

Chief of Stadium - Race Day

Planning & Check List

EVENT		DAY & DATE
DISTANCES		START TIME
TECHNIQUE	START METHOD & INTERVAL	
Stadium Area Tasks		
Time	Task	Responsible
	Open wax huts and day lodge	
	Set up temperature record and forms	
	Set up course, start, finish- and warm-up-area fencing/V-boards	
	Set up clothing storage	
	Place stadium signage	
	Place sponsors banners	
	Set up start area (lines & grids)	
	Set up finish lanes	
	Place results board	
	Set up finish-area refreshments	
Major Officials in Stadium		
POSITION	Name	Phone/Email
Chief of Start & Finish		
Chief of Stadium Preparation		
Chief of Timekeeping, Scoring & Data Processing		
Starter		
EQUIPMENT		

Chief of Timekeeping, Scoring & Data Processing - Race Day

Planning & Check List

EVENT		DAY & DATE
DISTANCES		START TIME
TECHNIQUE	START METHOD & INTERVAL	
Major Officials in Timekeeping		
Position	Name	Phone/Email
Chief of Primary Timing		
Chief of Backup Timing		
Announcer		
Announcer's Assistant		
Assignment	Task	
	Set up start area (lines & grids)	
	Set up finish lanes	
	Set up start-and finish-timing equipment	
	Place results board	
	Setup finish area refreshments	
Major Officials in Stadium		
POSITION	Name	Phone/Email
Chief of Start & Finish		
Chief of Stadium Preparation		
Chief of Timekeeping, Scoring & Data Processing		
Starter		
EQUIPMENT		

Sample Race Schedule – Interval Start

	A	B	C	D	E	F	G
1	Category	Open/U20 Men	U18 Boys	Open/U20 Women	U16 Boys	U18 Girls	U16 Girls
2	Course	E	E	A	A	A	B
3	Distance in Kms.	10	10	5	5	5	5
4	Laps	3	3	2	2	2	2
5	Fastest (Time / Km)	0:02:55	0:03:10	0:03:20	0:03:20	0:03:30	0:03:40
6	Slowest (Time/Km)	0:03:30	0:03:50	0:04:20	0:04:00	0:04:40	0:04:50
7	Runners	168	80	111	74	61	60
8	Start together	1	1	1	1	1	1
9	Interval	0:00:15	0:00:15	0:00:15	0:00:15	0:00:15	0:00:15
10	Times within Category						
11	Elapsed Time to Start Category	0:42:00	0:20:00	0:27:45	0:18:30	0:15:15	0:15:00
12	1st Lapper after Start	0:09:43	0:10:33	0:08:20	0:08:20	0:08:45	0:09:10
13	Last lapper after start	1:05:20	0:45:33	0:38:35	0:28:30	0:26:55	0:27:05
14	Total time to Finish	1:17:00	0:58:20	0:49:25	0:38:30	0:38:35	0:39:10
15	Times on Race Clock						
16	START	0:00:00	1:10:00	2:10:00	2:55:00	3:30:00	4:00:00
17	Last Start	0:42:00	1:30:00	2:37:45	3:13:30	3:45:15	4:15:00
18	1st Lap	0:09:43	1:20:33	2:18:20	3:03:20	3:38:45	4:09:10
19	Last Lap	1:05:20	1:55:33	2:48:35	3:23:30	3:56:55	4:27:05
20	1st Finish	0:29:10	1:41:40	2:26:40	3:11:40	3:47:30	4:18:20
21	Last Finish	1:17:00	2:08:20	2:59:25	3:33:30	4:08:35	4:39:10
22							
23	Clock start	9:00:00	9:00:00	9:00:00	9:00:00	9:00:00	9:00:00
24	Category start	9:00:00	10:10:00	11:10:00	11:55:00	12:30:00	13:00:00
25							

Sample Race Schedule – Mass Start

	A	B	C	D	E	F	G
1	Category	U16 Boys	U18 Girls	U16 Girls	Open Men	U20 Men	U18 Boys
2	Course	c	f	f	a	b	b
3	Distance in Kms.	7.5	10	7.5	50	30	15
4	Laps	3	4	3	7	4	4
5	Fastest (Time / Km)	0:03:05	0:03:44	0:04:00	0:02:42	0:02:57	0:03:00
6	Slowest (Time/Km)	0:04:30	0:05:24	0:06:03	0:04:18	0:04:12	0:04:20
7	Runners	63	53	53	95	55	74
8	Start together	999	999	999	999	999	999
9	Interval	0:00:00	0:00:00	0:00:00	0:00:00	0:00:00	0:00:00
10	Times within Category						
11	Elapsed Time to Start Category	0:00:00	0:00:00	0:00:00	0:00:00	0:00:00	0:00:00
12	1st Lapper after Start	0:07:43	0:09:20	0:10:00	0:19:17	0:22:08	0:11:15
13	Last lapper after start	0:22:30	0:40:30	0:30:15	3:04:17	1:34:30	0:48:45
14	First Finish	0:23:08	0:37:20	0:30:00	2:15:00	1:28:30	0:45:00
15	Total time to Finish	0:33:45	0:54:00	0:45:23	3:35:00	2:06:00	1:05:00
16	Times on Race Clock						
17	START	0:00:00	0:02:00	0:04:00	0:50:00	1:10:00	1:13:00
18	Last Start	0:00:00	0:02:00	0:04:00	0:50:00	1:10:00	1:13:00
19	1st Lap	0:07:43	0:11:20	0:14:00	1:09:17	1:32:08	1:24:15
20	Last Lap	0:22:30	0:42:30	0:34:15	3:54:17	2:44:30	2:01:45
21	1st Finish	0:23:08	0:39:20	0:34:00	3:05:00	2:38:30	1:58:00
22	Last Finish	0:33:45	0:56:00	0:49:22	4:25:00	3:16:00	2:18:00
23							
24	Clock start	9:00:00	9:00:00	9:00:00	9:00:00	9:00:00	9:00:00
25	Category start	9:00:00	9:02:00	9:04:00	9:50:00	10:10:00	10:13:00

APPENDIX 4 – COMPETITION SECRETARIAT FORMS

Race Notice Contents

Competition Name	_____
Host Community	_____
Dates	_____
Hosted by	Name of Host Club/Society
Sanctioned by	Nordiq Canada and/or Division
Location	Site name and directions to get to the site. GPS Co-ordinates
Competition Schedule	Include categories, distances, techniques, start times, types of starts and training schedules. (May be on attached page for large number of races and multiple day schedule).
Eligibility	Who may enter the Competition? Restrictions if any. Day License requirements.
Fees	Fee charged for each category - means of payment (online), credit card(s), cheque(s), payable to, applicable taxes etc.. Early bird discounts can encourage early registration. Late fees should be imposed a for the period within a few days of the competition. Note any charge for race bibs not returned.
Registration	Registration deadline – date, time and any restrictions. Entry (registration) site. Email address and web site
Facilities and Course	Course maps and profiles. Waxing and change facilities. All pertinent information.
Team captains' meetings	Date, time, and location including address and directions. Time of Draw if included.
Awards	What, where, when information.
Accommodation	Name. addresses, phone numbers and prices of lodging facilities and any special arrangements. Contact information for “more information” (usually supplied on attached sheets)
Transportation	Road maps, travel arrangements to site if provided. Local van and car rental agencies. (on attached sheet)
Banquet Information	Date, time, location, price and ticket information.
Attachment check list	Name and phone numbers of two key contact people. Schedule of events Course map(s) Transportation information

NOTE: Organizers should try to put all key information on one page as this page is often the only copy passed on.

It is recommended that the CS review race notices for similar events online – especially if they are new to the position.

Suggested Registration Information for web

Item	Nationals	NorAm	Division Cup	Club Event	School Event	Notes
First Name	Y	Y	Y	Y	Y	
Surname	Y	Y	Y	Y	Y	
YOB	Y	Y	Y	Y	Y	
Gender	Y	Y	Y	Y	Y	
Club	Y	Y	Y	Y		Drop down for Canadian Clubs
School	Y	Y	Y		Y	For CCUNC, OUA, High School
Team	Y	Y	Y	Y	Y	
Bib pickup	Y	Y	Y	Y	Y	Club, school, team or self
FIS License	Y	Y				
Canada License	Y	Y	Y			
Division License			Y			
Email	Y	Y	Y	Y		
Coach email	Y	Y	Y	Y	Y	
Coach cell #	Y	Y	Y	Y	Y	
Race 1 choice	Y	Y	Y	Y	Y	race description - drop down
Race 2 choice	Y	Y	Y			race description - drop down
Race 3 choice	Y	Y	Y			race description - drop down
Race 4 choice	Y					race description - drop down
Race 5 choice	Y					race description - drop down
Race 1 Category	Y	Y	Y	Y	Y	Drop down
Race 2 Category	Y	Y	Y			Drop down
Race 3 Category	Y	Y	Y			Drop down
Race 4 Category	Y					Drop down
Race 5 Category	Y					Drop down
Race entry fee	Y	Y	Y	Y	Y	Suggest 'early bird' discount and 'late fee' surcharge.
Division Fee	Y		Y			
Day License		Y	Y			
Other Fee						e.g. Ontario District
Banquet Ticket	Y					
Late Entry Surcharge						
Friends of Club						Fee waiver or discount

Sample Agenda – Team Captains’ Meeting

Competition Name _____

Date _____

AGENDA

TEAM CAPTAINS’ MEETING

- 1 Welcome
- 2 Roll call of Team Captains (by Division, Team or Club)
- 3 Introductions: (First Meeting)
 - Competition Committee
 - Technical Delegate
- 4 Review of matters arising from minutes of previous meeting
- 5 Congratulations to previous days winners.
- 6 Establish the Jury, accepting nominations (or make its pre-determined composition clear - to be chaired by the Technical Delegate)
- 7 Remarks by Technical Delegate
- 8 Weather report
- 9 Course information: Chief of Course
- 10 Stadium Information: Chief of Stadium
- 11 Clarification questions: e.g. Start order of categories
- 12 General Information: i.e. accommodation, transportation, banquet, awards
- 13 Information of time and location of distribution of bibs and Leg numbers
- 14 Information on available medical services
- 15 Date, time and location of next meeting

Liste de confirmation/Confirmation List ...

Registration

Liste de confirmation/Confirmation List

CCUNC Liste de confirmation/Confirmation List

Download to Excel

Bib Pickup	LastName	FirstName	Gender	Province	Club	Team	CCCL...	License...	FISLicense	USSA...	GPU Dist...	GPU Sp...	Inter...	Purs...	Long...	Short...
Bib Pickup: AIAWCA																
AIAWCA	Beatty	Dahra	F	Yukon	Whitehorse Ski Club	AIAWCA	22610		3105146		93.15	95.8	SW	✓		SW
AIAWCA	Bennett	Nicolas	M	Northwest Terri	Yellowknife Ski Club	AIAWCA	31425				83.56	85.84	JM	✓		JM
AIAWCA	Boehmler-Dandurand	Sebastien	M	Alberta	XC Bragg Creek	AIAWCA	28197		3100310		89.34	93.2	SM	✓		SM
AIAWCA	Dumais	Laurence	F	Quebec	Fondeurs-Laurentides	AIAWCA	25753	20239	3105213		84.69	87.75	SW	✓		SW
AIAWCA	Elliott	Elizabeth	F	British Columbia	Revelstoke Nordic	AIAWCA	31448		3105275		84.58	87.5	JW	✓		JW
AIAWCA	Granstrom	Beth	F	British Columbia	Revelstoke Nordic	AIAWCA	33141		3105270		84.42	84.19	JW	✓		JW
AIAWCA	Hébert	Elienne	M	Quebec	Montériski	AIAWCA	29287	24173	3100399		89.8	92.63	SM	✓		SM
AIAWCA	Jirousek	Hannah	F	Yukon	Whitehorse Ski Club	AIAWCA	34098				79.02	78.79	JW	✓		JW
AIAWCA	MacIsaac-Jones	Michael	M	Alberta	Rocky Mountain Racers	AIAWCA	21497		3100365		83.01	87.99	SM	✓		SM
AIAWCA	Mankelaw	Thomas	M	Alberta	Canmore Nordic	AIAWCA	29420		3100353		86.34	86.28	SM	✓		SM
AIAWCA	Nishikawa	Emily	F	Yukon	Whitehorse Ski Club	AIAWCA	13646		3105095		93.71	92.98	SW	✓		SW
AIAWCA	Randall	Nicholas	M	Ontario	Big Thunder Nordic	AIAWCA	31037		3100429		82.32	85.78	JM	✓		JM
AIAWCA	Thomson	Amanda	F	Yukon	Whitehorse Ski Club	AIAWCA	34099				83.7	85.83	JW	✓		JW
Bib Pickup: Arrowhead Nordic																
Arrowhead Nordic	De Gans	Riley	M	Ontario	Arrowhead Nordic		37779				78.92	69.7	JB	✓		JB
Arrowhead Nordic	Stroud	Raylan	F	Ontario	Arrowhead Nordic		38916				66.16	64.29	SW	✓		SW

Sample Confirmation List

Type here to search

4:48 PM
ENG 07-Apr-2021

Canadian Sanction Form

(located in the Document Centre on the Nordiq Canada website)



**Sanctions Cross Country: Disqualification – Competition
Suspension – Time Penalty – Written Reprimand – Monetary Fine**

Date

Competition:

Name of offender

Athlete Team Official

Nordiq Canada Racing License:

Division/Club:

Offender's hearing at: Time:

Violation against ICR/CCR article (2018):

ICR 325.4.2.9 False Start Rule – (sprint heats)

ICR 343.3 Not following instructions of the Jury

ICR 343.6 Did not follow the marked course

CCR 343.8 Violation of the classical technique rules

ICR 343.9 Obstruction: deliberately impeding, blocking (by not following best line), charging or pushing any competitor with any part of the body or ski equipment.

CCR 343.10 Improper Overtaking/Obstruction

ICR 343.13 Wrong exchange (Relay and Team Sprint)

ICR 352.2.3 Second Written Reprimand leading to a D SQ

Other:

Evidence:

Remarks:

Sanction decided by the Jury: Time:

Disqualification (352.2)

Competition suspension + Written Reprimand (352.3)

Written Reprimand (For competitors the second written reprimand will lead to disqualification) (352.5)

Time Penalty (352.4)

Monetary Fine (352.7): \$250 CAN:

Name and Signature TD:

Signature of offender:

Copy to:

- National Office--E-mail: jellis@nordiqcanada.ca
- Offender and Division Office of the offender
- Jury Meeting minutes and TD report

FIS Sanction Form

(located under Forms in the Document Library in the FIS website)



**Sanctions Cross-Country: Disqualification – Competition Suspension
Time Penalty – Written Reprimand – Monetary Fine – Verbal Reprimand**

Date: Codex:

Competition:

Name of offender:

FIS Code: Nation:

Offender's hearing at: Time:

Athlete: Team Official:

Violation against ICR article:

- ICR 207 Violation of the commercial markings rules
- ICR 343.6 Did not follow the marked course
- ICR 343.8 Violation of the classical technique rules
- ICR 343.9 **Obstruction:** deliberately impeding, blocking (by not following best line), charging or pushing any competitor with any part of the body or ski equipment.
- ICR 343.13 **Wrong exchange** (Relay and Team Sprint)
- ICR 344.1 **Not following special regulations of the Jury**
- Other

Evidence:

Remarks:

.....

Sanction decided by the Jury: **Time:**

- Disqualification
- Competition suspension + Written Reprimand
(Competition suspension is always accompanied by a Written Reprimand)
- Written Reprimand *(For competitors the second written reprimand will lead to disqualification)*
- Time Penalty:
- Monetary Fine: 250 CHF or:

Name and Signature TD:

Signature of offender:

- Copy to:
- FIS Office, CH-3653 Oberholten (Switzerland) e-mail: aechhoff@fiski.com
 - Offender and National Ski Association of the offender
 - Jury Meeting minutes and TD report

Canadian Protest Form

(located in the Document Centre on the Nordiq Canada website)

	Cross-Country - Official Protest
---	---

Date:

Competition:

Submitted by: Division:
(DIV Rep. or Team Captain)

Identify Persons Involved:

Name:	Bib or ID #	Name:	Bib or ID #

Reason for Protest and CCR References:

(Continue on reverse side if needed)
Signed by Nation's Representative/Coach: Signature: _____

Received by Competition Secretary's Office:

Received By: _____ Time: _____ Date: _____
Protest Fee Paid (specify amount and currency see CCR 381.4.3 re \$100 CAD): _____

Decision by the Jury:

Accepted: _____ or Rejected: _____
TD Name: _____ Signature: _____

Refer to CCR 381 for procedural details.

Copy to:

- Nordiq Canada Office: jellis@nordiqcanada.ca
- Offender and Division Office of the offender
- Jury Meeting minutes and TD report
- Official Notice Board

FIS Protest Form

(located under Forms in the Document Library in the FIS website)



Cross-Country – Official Protest

Date:

Competition:

Submitted by: Nation:
(NSA Rep. or Team Captain)

Identify Persons Involved:

Name:	Bib or ID #	Name:	Bib or ID #

Reason for Protest and ICR References:

(Continue on reverse side if needed)

Signed by Nation's Representative/Coach: Signature: _____

Received by Competition Secretary's Office:

Received By: _____ Time: _____ Date: _____

Protest Fee Paid (specify amount and currency see ICR 361.4.3 re 100 CHF): _____



Decision by the Jury:

Accepted: _____ or Rejected: _____

TD Name: _____ Signature: _____

Refer to ICR 361 for procedural details.

Copy to: Nation making this Protest, FIS Race Director, Jury Meeting Minutes and Official Notice Board



Accident Report Form

(located in the Document Centre on the Nordiq Canada website)



APPENDIX C
ANNEXE C

SPECIAL INSTRUCTIONS FOR REPORTING INCIDENTS ***Instructions spéciales pour la sauvegarde des rapports d'incidents***

Report all incidents promptly, regardless of how trivial they may seem.

Treat the injured person with courtesy and sympathy, but do not admit liability or make any commitments.

Do not attempt to render first aid above your trained ability. Seek medical assistance and make the injured person as comfortable as possible.

If the person is rendered unconscious, call the police or emergency hospital. If the person is conscious and the injury requires immediate medical attention, let the injured person name the doctor to be called. Never engage the service of a doctor without the consent of the injured person.

Get the names and addresses of all witnesses. Do this in a way that will not magnify the seriousness of the accident.

Inspect the place of the accident and the cause and conditions surrounding it. If possible, remove or have the cause removed immediately to prevent further accidents. Screen off or otherwise protect the area while clean-up is made. If there is no apparent reason for the accident, try to get the witnesses to inspect the scene.

Do not discuss the accident with anyone outside the company except representatives of Marsh Canada Limited after they have identified themselves. Co-operate with them in every possible manner. Caution any employees who may have witnessed the accident that that are likewise not to discuss it with outsiders.

Vous devez rapporter tous les accidents sans délai, peu importe leur gravité.

Le blessé doit être traité avec courtoisie et compassion, mais vous ne devez engager à rien, ni admettre votre responsabilité.

Il ne faut pas essayer d'administrer les premiers soins, uniquement reconforter le blessé.

Si le blessé est inconscient, appeler la police ou l'ambulance. S'il est conscient et que des soins médicaux sont nécessaires, laissez le blessé choisir le médecin à prévenir. Ne pas avoir recours aux services d'un médecin sans le consentement de blessé.

Il est important de noter les noms et adresses de tous les témoins, mais il faut éviter d'utiliser une attitude qui pourrait amplifier la gravité de l'accident.

Vous devez inspecter les lieux et examiner les causes et les circonstances de l'accident. Au cas où d'autres accidents risqueraient de se produire, il faut tenter d'éliminer toute cause de danger. Vous devez baliser ou protéger l'accès de la zone de l'accident pendant qu'on la nettoie. Au cas où l'accident n'aurait pas de cause évidente, il peut être utile de demander aux témoins d'inspecter les lieux.

Created October 2008, Latest Revision September 2020

Il ne faut pas discuter des circonstances de l'accidenté, excepté avec les représentants de Marsh Canada Limited, une fois que ceux-ci se sont fait connaître. Vous devez alors collaborer avec eux de votre mieux. Tous les employés témoins de l'accident doivent aussi être prévenus qu'ils ne doivent pas en parler avec des étrangers.

Report completed by NAME/NOM _____
 Rapport rempli par

SIGNATURE _____

DATE _____
 DAY / MONTH / YEAR

This report is prepared in contemplation of litigation and is to assist in the defence of the problem incident, accident or claim referred to herein. The accident report should be completed in the case of all injury to non-competitors, in the case of injury to competitors requiring hospitalization irrespective of whether it occurred in training or competition.

When an accident occurs, get full details and enter them on this form. Use the completed form as the basis to report the accident by telephone immediately to Marsh Canada Limited's office by giving them all the information. Make two copies, keep a copy on file for at least two years, send a copy to Canadian Snowsports Association, and send the original directly to the Marsh Canada Limited office within 24 hours after the incident.

Ce rapport est rédigé en prévision d'un litige pour documenter la défense de l'incident, accident ou réclamation dont il est question dans ce document. Le rapport d'accident doit être complète toutes les fois qu'un non-concurrent et toutes les fois qu'un skieur compétitive subit des blessures nécessitant de l'hospitalisation, que ce soit lors de compétition ou entraînement.

Lorsqu'un accident arrive, procurez-vous tout les détails et complétez le formulaire. Utilisez les renseignements recueillis sur le formulaire afin de rapporter immédiatement, par téléphone, l'accident au bureau de Marsh Canada Limited. Faites deux copies du formulaire, gardez-en une en filière, pour une période d'au moins deux ans et envoyez l'autre copie à Association Canadienne Sports d'Hiver et envoyez l'original directement au bureau de Marsh Canada Limited et ce, dans les 24 heures après l'accident.

1. Canadian Snowsports Association
 c/o David Pym
 Suite 265, 1177 West Broadway
 Vancouver, BC
 V6H 1G3
dpym@isrm.com
 Tel: 604-734-6800
 Fax: 604-669-7954

2. Marsh Canada Limited
 c/o Will Dear **and** Susanne Schurer
 800-550 Burrard Street
 Vancouver, BC
 V6C 2K1
William.Dear@marsh.com
Susanne.Schurer@marsh.com
 Direct Phone: 604-692-4873 (Will Dear)
 Fax: 604-685-3112

3. Discipline Office
 Insurance Manager



**MUST BE COMPLETED BY THE TD OR PERSON IN CHARGE
DOIT ETRE COMPLETÉ PAR LE DT OU LA PERSONNE EN CHARGE**

Insurance Assurance	Policy Holder Titulaire de police	CANADIAN SNOWSPORTS ASSOCIATION POLICY NO: No DE POLICE DE L'ASSOCIATION CANADIENNE DE SKI ET DE SURF DES NEIGES:
------------------------	--------------------------------------	---

Location of Accident SKI AREA
STATION DE SKI _____

Lieu de L'accident OWNER OF PREMISES
PROPRÉTAIRE DES LIEUX _____

OCCUPANT IN CONTROL
OCCUPANT EN CHARGE _____

CONTACT PERSON
NOM DE LA PERSONNE À
CONTACTER _____
NAME/NOM

ADDRESS/ADRESSE _____

ADDRESS/ADRESSE _____

()
TEL _____

DOES OCCUPANT LEASE DIRECT FROM OWNER OR ANOTHER (ATTACH COPY OF LEASE)? L'OCCUPANT D'ETIENT-IL SON
BAIL DIRECTEMENT DU PROPRIÉTAIRE OU D'UNE TIERS PERSONNE (JOINDRE UNDE COPIE DU BAIL)? _____

Accident or Occurrence
Accident ou Evénement DATE ____ / ____ / ____ TIME ____ TRAIL ____
DD MM YEAR HEURE PISTE

SKI CLUB
CLUB DE SKI _____

NAME OF THE COMPETITION OR TRAINING ACTIVITY _____
 NOM DE LA COMPÉTITION OU ENTRAÎNEMENT _____

NAME OF THE RACE CHAIRMAN OR PERSON IN CHARGE _____
 NOM DU DIRECTEUR DE L'ÉPREUVE OU DE LA PERSONNE RESPONSIBLE _____

ADDRESS/ADRESSE _____

ADDRESS/ADRESSE _____

() _____
 TEL. _____

DATE INSURANCE COMPANY NOTIFIED _____ BY WHOM/ _____
 PREMIER AVIS À LA COMPAGNIE D'ASSURANCE AVISÉ PAR _____

Injured Person
 Personne Blessé

NAME/NOM _____ AGE _____ SEX/SEXE _____

ADDRESS/ADRESSE _____

() _____
 TEL _____

STATUS: COMPETITOR _____ OFFICIAL _____ SPECTATOR _____
 COMPÉTITEUR OFFICIEL SPECTATEUR

CLUB/AFFILIATION _____ DIVISION _____

COUNTRY/PAYS _____

Nature of injury
 Description de la Blessure

Description of Accident or Occurrence:
Description de L'accident/événement:

Weather condition at time of accident:
Conditions Météorologiques au moment de l'accident:

Probable cause of Accident:
Raison probable de l'accident ou de l'événement:

First Aid Given:

NATURE OF TREATMENT/NATURE OF TRAITEMENT

MEDICATION GIVEN/MÉDICAMENTS DONNÉS

BY WHOM/ADMINISTRÉ PAR

HOSPITAL:
HOPITAL:

NAME OF HOSPITAL/NOM DE L'HOPITAL

METHOD OF TRANSPORTATION/MÉTHODE DE TRANSPORT

Doctor in attendance/Médecin traitant:

Witness:
Témoin:

NAME/NON

ADDRESS/ADRESSE

()

TEL

2nd Witness:
Temoin: _____
NAME/NON

ADDRESS/ADRESSE

() _____
TEL

Report of the TD:
Rapport de DT: _____
NAME/NON

ADDRESS/ADRESSE

() _____
TEL

Property Damage:
Dommages Matériels _____
OWNER/PROPRIÉTAIRE

ADDRESS/ADRESSE

DESCRIPTION OF PROPERTY/DESCRIPTION DES BIENS

ESTIMATED COST OF REPAIR OR REPLACEMENT/COUT ESTIMÉ DE LA RÉPARATION/REPLACEMENT

Other Insurance:
HOPITAL: _____
INSURER/ASSURER

POLICY NO. TYPE OF POLICY

Pre-competition Medication/Drug Use form



Pre-competition Medication/Drug Use form

Competitor		Date	
Name		License No.	
Club		Division	
This form is to be filled out by the athlete on medication/drugs.			
Hand to the Competition Secretary prior to the competition.			
Medication/Drug (Total dose per day)			
a. Long Term (e.g. vitamins, mineral supplements, herbal preparations)			
b. Short term			
Blood transfusion(s) in the past year?			
Yes		No	
Additional Comments:			
Signature of Athlete:			
Date:			
Time:			

Bib Bag Sheet Example

CLUB/TEAM: ARROWHEAD

TAKEN BY: _____
PLEASE PRINT!

CLUB/TEAM: BARRIE CROSS COUNTRY

TAKEN BY _____:
PLEASE PRINT!

CLUB/TEAM: BIG THUNDER

TAKEN BY: _____
PLEASE PRINT!

Leg Number Instructions

Leg Sticker Instructions

Instructions pour les Autocollants de Jambes

Apply to the right calf (ie. between the ankle and knee).
Appliquer au mollet droit (ie. entre la cheville et le genou).

For best adhesion, apply to race suit while still indoors.
Pour une meilleure adhésion, appliquez-le à la tenue de course en intérieur.

😊 Do NOT apply to warm-ups 😊
😊 NE PAS appliquer au warm-ups. 😊



If your number has a six or nine in it, make sure it is right side up!

Si votre numéro compte un nombre de six ou neuf, assurez-vous que c'est à droite!

Bib pick list sample

Team Grouping: Big Thunder Nordic Ski Club					
Bib	FirstName	Surname	Category	CCCLic	Team
217	Max	Hollmann	Junior Boys	35400	Big Thunder Nordic Ski Club
220	Alexander	Randall	Junior Boys	31038	Big Thunder Nordic Ski Club
255	Matthew	Randall	Juvenile Boys	36421	Big Thunder Nordic Ski Club
311	Carley	Kiskila	Juvenile Girls	38921	Big Thunder Nordic Ski Club
317	Sarah	Cullinan	Juvenile Girls	42382	Big Thunder Nordic Ski Club

Team Grouping: Carleton					
Bib	FirstName	Surname	Category	CCCLic	Team
102	Zoë	Williams	SENIOR WOMEN	27368	Carleton
107	Chloe	Ranshan	JUNIOR WOMEN	33123	Carleton
108	Maggie	McClure	SENIOR WOMEN	30248	Carleton
109	Alyssa	Stowe	SENIOR WOMEN	27371	Carleton
110	Laura	Inkila	SENIOR WOMEN	25805	Carleton
118	Shelby	Howard	SENIOR WOMEN	29274	Carleton
141	Jordyn	Leighton	SENIOR WOMEN	44645	Carleton
145	Alexandra	Slobodian	SENIOR WOMEN	13717	Carleton
151	Aidan	Kirkham	SENIOR MEN	31823	Carleton
159	Ezra	Pierce	JUNIOR MEN	31058	Carleton
163	Brendan	Howard	SENIOR MEN	25712	Carleton
165	Devon	Pegrum	JUNIOR MEN	37672	Carleton
172	Colin	Ward	SENIOR MEN	29432	Carleton
181	Sander	Van Walraven	JUNIOR MEN	33751	Carleton
200	Thomas	Saville	SENIOR MEN	44648	Carleton
206	Eric	Macneil	SENIOR MEN	32888	Carleton

Team Grouping: Georgian Bay Nordic					
Bib	FirstName	Surname	Category	CCCLic	Team
214	Dylan	Beck	Junior Boys	33351	Georgian Bay Nordic
224	Wesley	Schlenker	Junior Boys	35296	Georgian Bay Nordic
282	Colleen	Beck	Junior Girls	31855	Georgian Bay Nordic

Sample Leader Bib List for Timers

LEADER BIBS (no bib #) **SUNDAY**

		BIB # PER START LIST
ONT Open Women	Jessica Roach (Hardwood)	130
ONT Open Men	Aiden Kirkham (Nakkertok)	20
ONT Junior Women	Chloe Ranahan (Nakkertok)	120
ONT Junior Men	Pierre Grall-Johnson (NTDC-TBay)	25
ONT Junior Girls	Colleen Beck (GBN)	399
ONT Junior Boys	Guillaume Pelchat (Pembroke)	329
ONT Juvenile Girls	Katya Semeniuk (Nakkertok)	254
ONT Juvenile Boys	Robin Mason (Nakkertok)	173

Relay Declaration Form Example

Event: _____

Please note deadline dates and times for Team Declaration and Final Team Order

Relay Event	Race Date	Initial Declaration	Final Team Order
CCUNC	Friday 2003-03-07	Due 2003-03-06 4pm <input type="checkbox"/>	Due 2003-03-07 8am <input type="checkbox"/>
Junior Challenge	Sunday 2003-03-09	Due 2003-03-08 4pm <input type="checkbox"/>	Due 2003-03-09 8am <input type="checkbox"/>
Junior Open	Sunday 2003-03-09	Due 2003-03-08 4pm <input type="checkbox"/>	Due 2003-03-09 8am <input type="checkbox"/>

Team Name _____ Male Female

Leg	License #	Name
1		
2		
3		
1 st Alternate		
2 nd Alternate		

Team Captain's Name

Signature

Received by Race Secretary _____ Date: _____

Initials: _____ Time: _____

Note: The same format can be used for Team Sprints, however only one Alternate may be declared.

Team Sprint Substitutions Example

- * Friday at 4:00 pm. Substitutions for force majeure. Modified team will be seeded.
- * Saturday at 8:00 am. Substitutions for force majeure. Modified team forfeits seeding.
- * No other changes allowed.

N.B. Starting Order cannot be changed

In which event is the team registered?

- Club Team Sprint
 CCUNC Team Sprint

Club/University:

Athlete's License & Name:

Substitute's License & Name:

Reason for Substitution:

Coach's Name:

Coach's Signature:

Received by Race Office: _____ Date & Time _____

Team Relay Substitutions Example

- * 4:00 pm the day before the race. Substitutions for force majeure. Modified team will be seeded.
- * 8:00 am the day of the race. Substitutions for force majeure. Modified team forfeits seeding.
- * No other changes allowed.

N.B. Starting Order cannot be changed.

In which event is the team registered:

- Club Relay
 CCUNC Relay

Club/University:

Athlete's License & Name:

Substitute's License & Name:

Reason for Substitution:

Athlete's License & Name:

Substitute's License & Name:

Reason for substitution:

N.B. Substitute athletes must be previously declared as Alternates.

Coach's Name:

Coach's Signature:

Received by Race Office: _____ Date & Time _____

Sample Notification of Withdrawal

NOTIFICATION of WITHDRAWAL

COMPETITION: 2018 Ski Nationals – Lappe Nordic Ski Center

Day	Date		Race Event	Category	Comment
1	Mar 10	Sat	Team Sprint	<input type="checkbox"/>	
2	Mar 11	Sun	CI – Int Start	<input type="checkbox"/>	
4	Mar 13	Tue	Fr - Pursuit	<input type="checkbox"/>	
5	Mar 14	Wed	Fr – Long Sprint	<input type="checkbox"/>	
6	Mar 15	Thu	Fr – Short Sprint	<input type="checkbox"/>	
8	Mar 17	Sat	CI – Mass Start	<input type="checkbox"/>	

Name of Athlete: _____ Male Female

License #: _____

Team Name: _____

Team Captain: _____

Signature: _____

RECEIVED BY COMPETITION SECRETARY

Date: _____ Time: _____ Initials: _____

Copy to zone4 race file Corrected in zone4 by: _____

Eligible for Refund:
 Yes No Amount: _____ Cheque # _____

Refund received by: (print) _____

Date: _____ Signature: _____

Sample Clipboard/Forms Request

Clipboard/Forms Requirements 2018 Haywood Nationals
10 March to 17 March 2018

WHAT DO YOU NEED TO GET THE JOB DONE?

email completed forms to marlersteph@yahoo.ca

Please complete a separate form for each race day/event

Chief of:

Name:

Day 1 – Sat – Team Sprints – Classic

Day 1 – Sat – Interval Start – Classic
(Para Nordic & Midget/TA Exhibition Race)

Day 2 – Sun – Interval Start – Classic

Day 4 – Tues – Pursuit Race - Free

Day 5 – Wed – Long Sprints – Free

Day 6 – Thurs – Short Sprints – Free

Day 8 – Sat – Mass Start - Classic

Instructions for Clipboards

(Race Office to copy & prepare for race day)

List Volunteer or Position

And what should be on their clipboard

All clipboards will include 2 pencils and a cover

Provide a copy of blank FORMS and
INSTRUCTIONS for # of copies

Sample Radio Sign Out

RADIOS

Upon Pickup: TEST all channels / understand use

Upon Return: TURN OFF POWER / PLACE IN CHARGER

Date:

Channel 1: Race Channel 2: Jury Channel 3: Timing

GROUP	Radio Number	Alternate Number	PICKED UP BY (print name)	RETURNED BY (print name)
Chief of Competition				
Technical Delegate				
Assistant TD				
CCC Race Director				
Chief of Competition Control				
Race Office				
Medical Chief				
Chief of Course				
Chief of Stadium				
Chief of Timekeeping, Scoring & Data Processing				
Chief of Primary Timing				
Chief of Backup Timing				
Computer Operator Primary				
Computer Operator backup				
Chief of Start				
Finish-Line Team Leader				
Lap-Time Team Leader				
Course Controller #1				
Course Controller #2				
Course Controller #3				
Course Controller #4				
Course Controller #5				
Course Controller #6				
Announcers				
Awards Co-ordinator				

Course-Salting Disclaimer

<Event Letterhead>

Date

To Whom It May Concern:

Please be advised that the individuals presenting this letter have been competing in <name of city> at the <name of Club>'s <name of ski event>. Due to weather and snow conditions it was necessary for the organizers to use fertilizer high in nitrogen content to treat the snow in order to preserve the racecourse. As a result, there could be traces of these products on the competitors clothing, boots or skis.

We wish to avoid any incidents at the airport if chemicals are detected and appreciate your consideration.

Sincerely,

<name of organizing committee>

<name>

<title>

<contact #>

APPENDIX 5 – TIMING AND SCORING FORMS & REPORTS

Start List Formatted as Start-Time Record – Z4 Legacy Program

Haywood NorAM CEC Pursuit Day 1 2019		Date: February 2, 2019
Start List		Location: Duntroon
Jury		
Technical Delegate:	Jacques Dumont	
Chief of Competition:	Shawn Sinclair	
Assistant TD	Pierrot Bernier	
Apprentice TD	Claude Laramée	
CCC Race Director	Dave Dyer	

Open Women - 10 km. Classic - 2 Laps x 5K

Bib	Name	CCCLic	DOB	Club	Start	Recorded Start Time
141	Alexandra Racine	29499	1999	Orford		11:04:15.0
142	Laura Leclair	27396	1997	Chelsea Nordiq (QC)		11:04:30.0
143	Tove Halvorsen	31050	1999	Nakkertok Nordique (QC)		11:04:45.0
144	Bronwyn Williams	31834	1999	Nakkertok Nordique (QC)		11:05:00.0
145	Erin Yungblut	21597	1993	Rocky Mountain Racers		11:05:15.0
146	Katie Weaver	26344	1997	Hollyburn Ski Club		11:05:30.0
147	Frédérique Vézina	19234	1994	C.N.E.P.H		11:05:45.0
148	Annika Richardson	27417	1998	Lappe Nordic		11:06:00.0
149	Mia Serratore	23769	1996	Big Thunder Nordic		11:06:15.0
150	Hannah Shields	37995	1998	Nakkertok Nordique (QC)		11:06:30.0
151	Zoë Williams	27366	1997	Nakkertok Nordique (QC)		11:06:45.0
152	Liliane Gagnon	36478	2002	Skibec		11:07:00.0
153	Alannah Maclean	19646	1993	Big Thunder Nordic		11:07:15.0
154	Madeline Aarts	DL47	1997	University of Guelph		11:07:30.0
155	Marina Tusz	DL31	1998	Laurentian Nordic		11:07:45.0
156	Miriam Lutes	DL38	2000	University of Guelph		11:08:00.0
157	Jillian Flower	DL5	1973	Individual		11:08:15.0
158	Sydney Raspberry	DL13	1999	Queen's University		11:08:30.0
159	Jasmin Tuhkasaari	DL36	1998	University of Guelph		11:08:45.0
160	Lydia Harris	DL35	1997	Laurentian Nordic		11:09:00.0
161	Isabelle Maclean	DL49	1995	Walden Cross Country		11:09:15.0
162	Katja Zbogor	DL23	1998	Team Hardwood		11:09:30.0
163	Jordyn Leighton	DL68	1998	Carleton University		11:09:45.0



Time Record

Bib #	HH	MM	SS	T
	:	:	.	
	:	:	.	
	:	:	.	
	:	:	.	
	:	:	.	
	:	:	.	
	:	:	.	
	:	:	.	
	:	:	.	
	:	:	.	
	:	:	.	

Initials: _____ Sheet # _____



Time Record

Bib #	HH	MM	SS	T
	:	:	.	
	:	:	.	
	:	:	.	
	:	:	.	
	:	:	.	
	:	:	.	
	:	:	.	
	:	:	.	
	:	:	.	
	:	:	.	
	:	:	.	
	:	:	.	

Initials: _____ Sheet # _____

Lane Assignments – Mass-Start Chevron – Racers View

*****START LINE*****

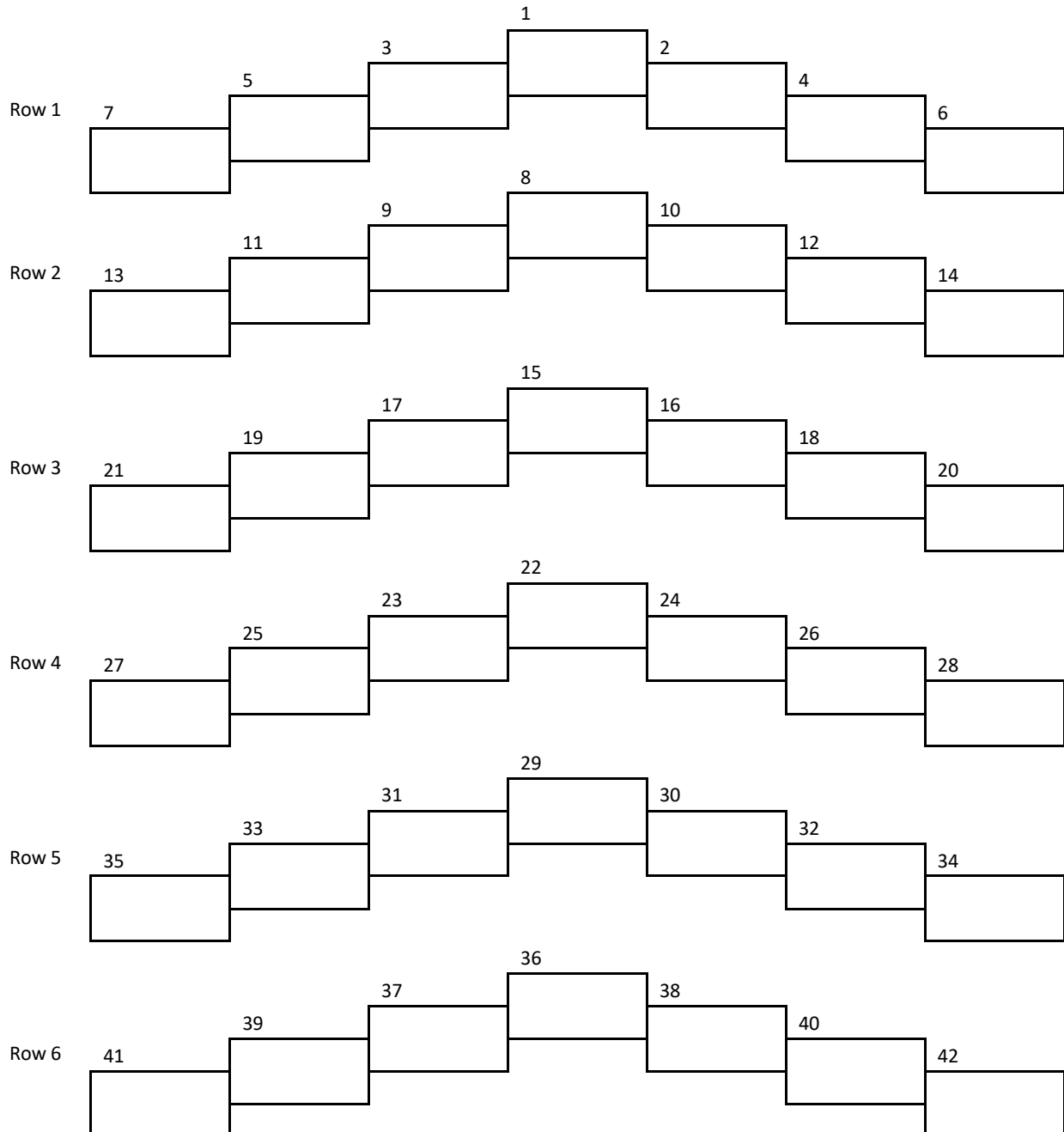

Lane Assignments – Mass-Start Chevron – Starters View

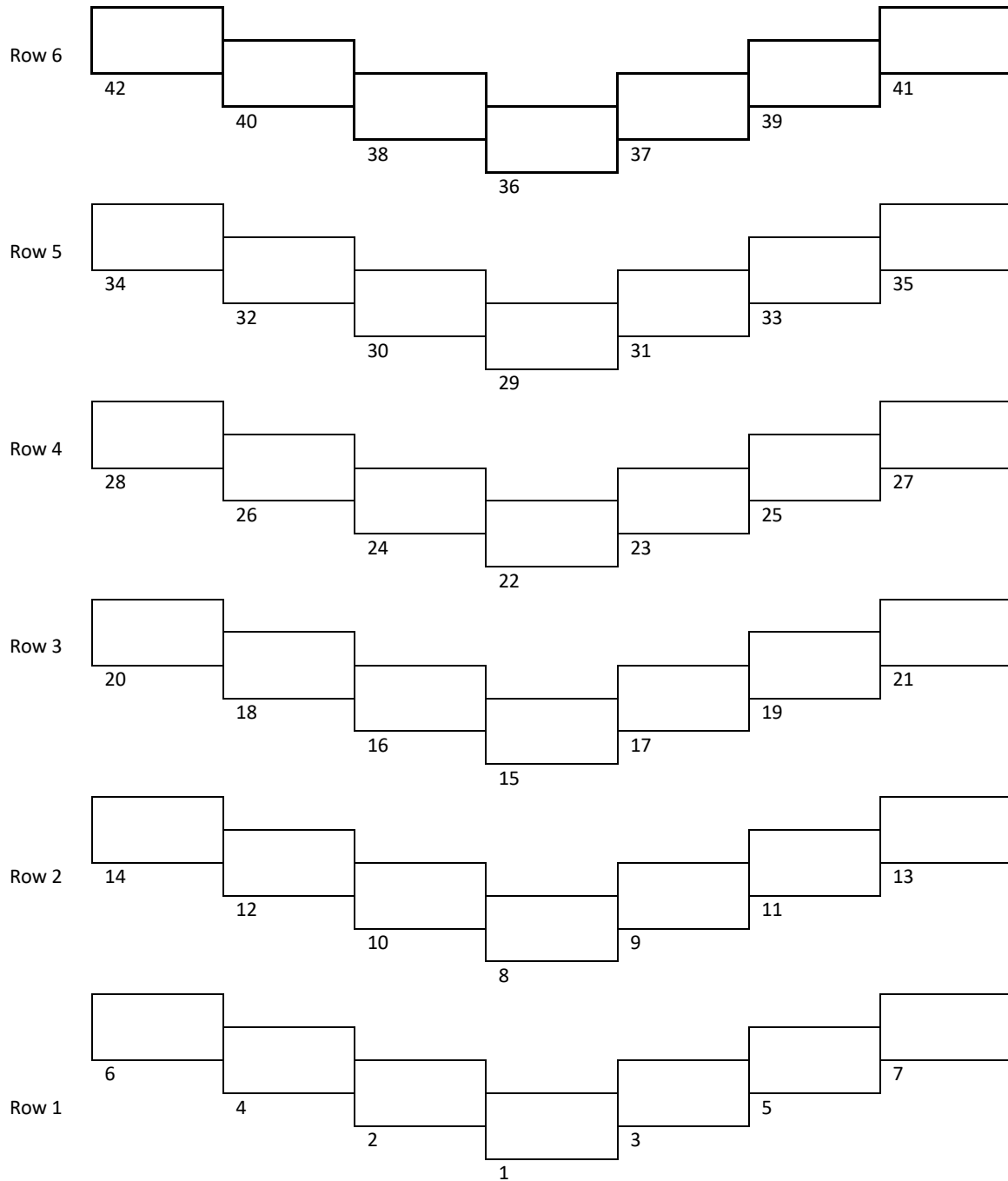

*****START LINE*****

Sprints – ORDER OF FINISH BY LANE

Name of Official :

Sheet #:

Category:

Round:

Quarter Final

Semi Final

Final

Instructions: For each heat record the lane number for each finisher – i.e. 1, 2, 3 or 4.

Heat	1 st	2 nd	3 rd	4 th	5 th	6 th
1						
2						
3						
4						
5						

Sprints – BIB ORDER OF FINISH IN LANE

Name of Official: _____ Sheet #:

Category: _____ Round: Quarter Final Semi Final Final

Lane

Instructions: For each heat record the Bib numbers for your lane ONLY.

Heat	1 st	2 nd	3 rd	4 th	5 th	6 th
1						
2						
3						
4						
5						

Sprints – Consolidated Lane & Bib Order

Officials Name: _____

Record Lane & Bib #'s in order of Finish

Heat (Category & Round)	1 st	2 nd	3 rd	4 th	5 th	6 th
Lane						
Bib						
Lane						
Bib						
Lane						
Bib						
Lane						
Bib						
Lane						
Bib						

APPENDIX 6 – COMPETITION CONTROL FORMS

Bib Order Form



Bib Order

Position: _____ Initials: _____ Sheet # _____

	1	11	21	31
1				
2				
3				
4				
5				
6				
7				
8				
9				
10				

Fill in: down and then across

Lap Count Form

Competition: _____

Position: _____ Initials: _____ Sheet #: _____

Put a check mark in the square that matches the bib number of the skier each time they pass.

1	2	3	4	5	6	7	8	9	10
11	12	13	14	15	16	17	18	19	20
21	22	23	24	25	26	27	28	29	30
31	32	33	34	35	36	37	38	39	40
41	42	43	44	45	46	47	48	49	50
51	52	53	54	55	56	57	58	59	60
61	62	63	64	65	66	67	68	69	70
71	72	73	74	75	76	77	78	79	80
81	82	83	84	85	86	87	88	89	90
91	92	93	94	95	96	97	98	99	100

Controller Form – Obstruction & Other Violations

Controller's Name: _____ Location: _____

Decision Model for:	Obstruction
Did the overtaking skier stay clear? Jury: 343.10.2	Bib # of overtaking skier: _____ Did skier stay clear? Yes ____ No ____
Was the act intentional? (Who initiated the action?) Jury: 223.1.3	Which Bib No. initiated the action? ____
Did the skier obtain an advantage? Jury: 223.3.3	Yes ____ No ____

Decision Model for:	Other violations
Did the action either jeopardize the security of persons or property or actually cause injury or damage? Jury: 352.2.2	Yes ____ No ____ Brief description:
Did the action violate the rules of responsibility of the competitor during the competition or demonstrate unsportsmanlike behavior? Jury: 223.1.1	Yes ____ No ____ Brief Description:

Controller Form – Technique Violation

Controller's Name: _____ Location: _____

Decision Model for:	Classical technique Violation
Jury: 310.2.2.1	<p>Classical technique includes the diagonal stride technique, double poling with or without diagonal kick, herringbone without a glide phase and turning techniques.</p> <p>Diagonal Stride technique is comprised of alternating diagonal movements of both arms and legs and includes diagonal stride and herringbone techniques without a gliding phase. In diagonal technique a maximum of one pole is in the ground at any time.</p> <p>Turning techniques are comprised of steps with the inner ski and pushes with the outer ski in order to change skiing directions. The sections of the course where turning techniques are allowed must be clearly marked.</p> <p>Where there are one or more set tracks, repeatedly changing or stepping in and out of tracks is not allowed.</p> <p>Single and double-skating is not allowed.</p>
310.2.2.2	
310.2.2.3	
310.2.2.4	
310.2.2.5	
Consideration:	Bib No. of Skier _____
Was an edge set?	Yes ___ No ___
Was there a glide phase?	Yes ___ No ___
Was it a push to change direction?	Yes ___ No ___
Was there a marked turning zone?	Yes ___ No ___
How many pushes?	1 ___ 2 ___ 3+ ___
Were there alternate pushes?	Yes ___ No ___
How many?	1 ___ 2 ___ 3 ___
Was the skier changing lanes?	Yes ___ No ___
Were the pushes necessary to maintain balance? Jury: 223.1.3	Yes ___ No ___
Was skier in a Technique Zone? Jury: 310.2.1	Yes ___ No ___
Was Diagonal Stride not used? Jury: 310.2.2.2	Yes ___ No ___

APPENDIX 7 – COURSE FORMS/MAPS ETC.



Temperature Record

Competition:					Date:				
Name:									
Turn this record in to Competition Secretary after the last entry.									
Time	Air Temp			Snow Temp			Humidity	Wind Vel/Direction	
	Stadium	High	Low	Stadium	High	Low			

Course Map and Profile

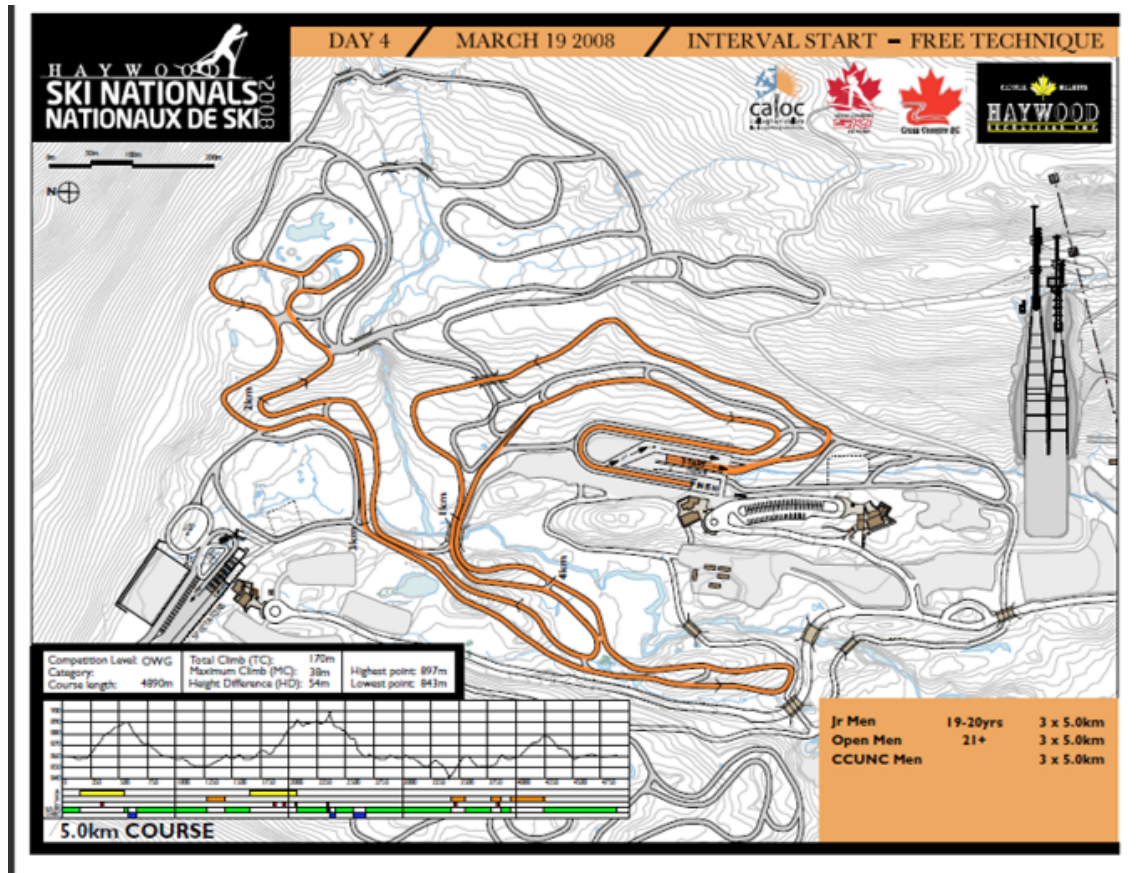

APPENDIX 8 – PARA NORDIC COMPETITIONS

Paralympic versus Olympic Nordic Skiing

The Para Nordic Cross Country Skiing in most cases follows the same rules, regulations and event procedures as the International Ski Federation (FIS). It should be noted that Para Nordic athletes also take part in biathlon at World Cup and Olympic levels. This is rare in domestic events and is not covered in this manual. However, in certain areas, the differences are notable and explained below:

- Competition formats
- Athlete classification
- Percentage system
- Timing and results
- Wheelchair accessibility and facilities
- Competition rules are defined in the World Para Nordic Skiing Rules and Regulations

COMPETITION FORMAT	Standing	Sit-ski
Cross Country Sprint*	1200m* +/- 400m	800 m* +/- 300m
Cross Country Short Distance	2.5 km Women	2.5 km Women
	5 km Men	5 km Men
Cross Country Middle Distance	7.5 km Women	5 km Women
	10 km Men	7.5 km Men
Cross County Long Distance	15 km Women	12 km Women
	20 km Men	15 km Men
Cross Country Relay	3 x 2.5 km Women	
	1 x 3.75 km (sit-ski) + 2 x 5 km (standing)	

Classification of Athletes

For the competitions, all standing impairment classes are combined into one standing category. All sitting-impairment locomotor-disabled classes are combined into one sitting category, and all visually-impaired classes are combined into one category with the appropriate utilization of the percentage system for Nordic Skiing. The following table describes in general terms the current classification system:

Category	Class	Region of impairment	Main sport equipment
Visually Impaired	B1	No light perception in either eye up to light perception, but inability to recognize the shape of a hand at any distance or in	Must ski with a guide and wear special black

		any direction.	goggles
	B2	From ability to recognize the shape of a hand up to a visual acuity of 2/60 and/or visual field of less than 5 degrees.	Must ski with a guide
	B3	From visual acuity above 2/60 up to visual acuity of 6/60 and/or visual field of more than 5 degrees and less than 20 degrees.	May ski with a guide
Standing	LW 2	Single above-knee amputation with a prosthesis or comparable.	Skiing with 2 skis and 2 poles
	LW 3	Double below-knee amputations or comparable.	Skiing with 2 skis and 2 poles
	LW 5/7	Double upper-limbs amputations or comparable.	Skiing with 2 skis and no poles
	LW 6	Single upper-limb amputation above the elbow or comparable.	Skiing with 2 skis and 1 pole
	LW 8	Single upper-limb amputation below the elbow or comparable.	Skiing with 2 skis and 1 poles
	LW 9	Severe disability in upper and lower limbs i.e. amputation or comparable (one side, diagonal or a combination of more limbs).	Equipment of their choice, but with 2 skis
Sitting	LW 10	Impairment in the lower limb(s) and no functional sitting balance.	Using sit-ski
	LW 10.5	Impairment in the lower limb(s) and with minimal to marginally adequate functional sitting balance.	Using sit-ski
	LW 11	Impairment in the lower limb(s) and with <u>adequate</u> functional sitting balance.	Using sit-ski
	LW11.5	Impairment in the lower limb(s) and with <u>better than adequate</u> functional sitting balance and loss of sensation in buttock(s) and back of thigh(s).	Using sit-ski
	LW 12	Impairment in the lower limb(s) and with good functional sitting balance.	Using sit-ski

Percentage system

The percentage-system uses percentage factors that reflect the relative effect of impairment between each class within a category. These factors are adjusted annually based on competition results of athletes competing at the World-Cup level and above. During the competition, the athlete's real time is multiplied by the percentage to determine his/her adjusted time. Different percentages apply for the two techniques, classic and free technique.

Percentages used for the season 2019-2020:

Class	Classical technique	Free technique
B1	88%	88%
B2	99%	99%
B3	100%	100%
LW 2	92%	93%
LW 3	86%	88%
LW 4	96%	96%
LW 5/7	79%	89%
LW 6	90%	96%
LW 8	92%	97%
LW 9	88%	89%

Class	Classic
LW 10	86%
LW 10,5	89%
LW 11	93%
LW 11,5	95%
LW 12	100%

Timing & Results

The classification/percentage system creates a need for a unique results system. The real race time for each competitor is multiplied by the competitors' class or individual percentage before the final times and ranking is based on calculated time. Both the real time and the calculated times, as well as the athletes' percentages are shown on the final results.

Special formulas are used to calculate pursuit start times used in sprint and pursuit races.

In WPNS cross country competitions, any time adjustments due to early/late starts are added to the athlete's real time while time penalties are added to the calculated time.

Any Lap times shown in the result lists, must be shown as calculated times. Any time information shown on the venue's scoreboard or announced by the public announcer must be the athletes' calculated time.

The unofficial and official start and result lists shall include the last name and first initial of the race guide of each visually impaired athlete.

Full details can be found in the World Para Nordic Skiing Rules and Regulations on the WPNS website.

Wheelchair accessibility and facilities

The competition venue needs to accommodate wheelchair access to all team preparation areas, as well as to the start, finish and awards areas. It is important that the Sit-ski athletes are easily able to move from the parking lot to the athlete preparation area (wax cabins), and from there to the stadium or start of the groomed trails or snow surface.

Similarly, it is necessary to provide an accessible surface for the sit-ski athlete to the flower- or awards podium if this is set up inside the stadium (the athletes are expected to be in their wheel-chairs at this time)

The most practical surface for wheelchair access is simple sheets of plywood that is laid down on the ground or the snow, and perhaps covered with a carpet to provide a non-slip surface.

Awards may also be presented to athletes in their sit skis immediately after a race. In these cases, the podium may be a raised or flat snow surface. When flat surfaces are used, it is common to use a low first, second and third place marker in front of each position.

Specific technical WPNS rules

The WPNS rulebook follows the same structure, general format and numbering system as the FIS rulebook. Many of the general competition rules are the same as the FIS rules. However, there are multiple differences throughout that are specific to Para Nordic competitions and formats. A few of the obvious differences include, (but are not limited to), the following:

Goggles: B1 class athletes must wear black out (opaque) that cover their eyes and allow no light perception when worn.

Assistance: Event volunteers are allowed to help a sit-skier that have crashed, and assist them in getting back onto the track if needed

Guides: The athletes in the B1 and B2 classes must use a guide during the whole competition. For the B3 athletes a guide may be used

It is allowed to change guides during the competition. Guides are allowed to use amplifiers, radios etc. for communicating with their skiers.

The guides are considered athletes, and must receive the same recognition and awards as the visually impaired athlete (listed on the start and result lists, medals, prizes etc.)

For reasons of safety, the guide is allowed to hold a B1 competitor (one arm or one pole) anywhere on the course but is not allowed to pull or push the athlete.

At the start the Guide will be placed ahead of the start gate in the track or off to the side of the track depending on the preference of the visually impaired athlete.

For all B classes the start and finish times will be taken as the competitor and not the guide crosses the line. The guide does not pass through the starting gate but will cross the finishing line.

Sit ski athletes are not allowed to use a leg or foot for steering.

Competition courses

The width of the courses is increasingly important due faster speeds and new race formats.

The following table lists recommendations for width of competition courses:

Competition Format	Course width
Interval start, classical technique	Minimum 3 m (1 track)
Relay, classical technique	Minimum 4 m (2 tracks)
Interval start, free technique	Minimum 6 m
Relay, free technique	Minimum 6 m
Sprint start	Minimum 8 m

Where sit-ski courses and standing courses are together, it is important to provide enough width to accommodate both, and to avoid that the sit-ski (classical) tracks are being destroyed by other skiers skating across them. The minimum width between the two sit-ski tracks is 1.5 m (total of 3 - 4 m), and with a skating surface of 5 - 6 m (in case of a biathlon race, for example), implies that the total width of the common course should be about 9m. See WPNS Homologation Guide for full details.

Guide Bibs

The guides will wear a brightly-coloured bib (yellow or orange) printed with a "G" indicating the word "guide".

Equipment: Special Rules for Sit Skiers

- 224.9.1 The Para-Nordic sit ski shall consist of a sitting device mounted on a pair of cross country skis.
- 224.9.1.1 The maximum allowable height difference between the top of the seat and the top of the skis is 40cm.
- 224.9.1.2 The sit-ski athlete shall be seated on the sit-ski at all times during the race, meaning that the athlete's buttocks shall remain in contact with the seat in accordance with the World Para Nordic Skiing Classification Rules & Regulations.
- 224.9.1.3 To prevent movement of the buttocks off the seat, the upper thigh (proximal femur) or hip must be strapped to the seat using a non-flexible material.

Homologation of Courses for Para Nordic Skiing

Courses for the sit-ski category cannot follow FIS homologation rules due to the fact that sit-skiers have no use of their lower body and pull themselves forward with poles from a sitting position (on their sledge).

The categories for A, B and C hills are therefore proposed to be changed to:

A-hills 10 - 15m PHD and gradient between 4 – 12 %

B-hills 4 - 9m PHD and gradient between 4 – 12 %

C-hills 2 - 4m < 30 m and gradient >12 %, maximum 16%

The following points should also be considered when designing courses for the sit-ski category:

- uphill should in general not be steeper than 10 - 12 % gradient
- A-hills should not be too long (not over 250 m in length)
- downhill should have straight run-outs preferably with a slight uphill to break the speed, the hills should not be steeper than 12 – 14 % gradient
- corners and turns should be placed where the speed is slow corners on flat part of the course should optimally not be less than 90 % angle (larger angle required for downhill corners). This applies in the stadium as well, for example for lapping or into the shooting range. (NOTE: If you as a standing skier are poling without using the legs, the skis should easily follow the track both in curves/bends in flat parts and also in downhills – if we have to “work” with the legs, a sledge will have problems)

The HD, TC and MC of the homologated competition courses should be within the following norms:

Course	TC	MC	HD	Hills
3.0 km	35-65	15	40	1 – 2 A hills, 2 – 4 B hills
2.5 km	30-60	15	40	0 – 1 A hills, 1 – 3 B hills
2.0 km	25-55	15	40	0 – 1 A hills, 1 – 3 B hills
800m	0-30	15		

Stadium Layout

In contrast to the newest development of stadiums and course layouts for FIS competitions, it is less important to ski through the stadium often in Para Nordic competitions, since most competitions are interval-start races. Since Para Nordic skiing events are divided into six categories (three for men and three for women), it is difficult for announcers and spectators to follow the event if several categories are starting, passing through the stadium or finishing at the same time. For competitions with small fields, this situation can however be solved by letting each category finish the race before the next one starts.

A special consideration should be given to the transition and staging area for the sit-ski category. This should be provided with an easy, flat access to start and finish areas, with nearby covered and heated area for transition from wheelchair to sit-ski.

APPENDIX 9 – START LISTS AND RESULTS

Start List – Interval Start – Z4 Web Based Program



Qualifier - Alta Gas Sprint YOG Trial, Free – Start List

2019-12-06 Canmore Nordic Centre

Jury		Weather	
TD	Ian Sibbald	Temperature	-6C
ATD	Dan Brisbin	Snow	artificial
Chief of Competition	Jim Hendry	Conditions	Overcast
Race Director	Jeff Ellis	Wind	light

YOG Trials, Open Women 1.3 k Free

1.3km Sprint

#	Start Time	Name	Chip	CCC Lic.	FIS Lic.	CPL Pts	FIS Pts
1	12:00:15	Maya Macisaac-Jones Senior Women 1995 Rocky Mountain Racers AIAWCA	C1	20511	3105180	94.05	94.75
2	12:00:30	Katherine Stewart-Jones Senior Women 1995 Nakkertok Nordique (QC) CN Ski Team	C2	23772	3105214	93.78	99.94
3	12:00:45	Kaitlynn Miller Senior Women 1991 Craftsby Nordic Craftsby Green Racing Project United States	C3	34048	3535636	93.7	108.93
4	12:01:00	Alayna Sonnesyn Senior Women 1996 Stratton Mountain School	C4	34852	3535659	93.36	100.46
5	12:01:15	Erika Flowers Senior Women 1989 Bridger Ski Foundation Salomon United States	C5	18861	3535222	93.21	111.07
6	12:01:30	Katharine Ogden Senior Women 1997 Dartmouth Ski Team	C6	31366	3535601	92.32	135.5
7	12:01:45	Elizabeth Guiney Senior Women 1991 Craftsby Nordic Craftsby Green Racing Project United States	C7	20461	3535408	92.17	119.15
8	DNS	Sadie White Senior Women 1996 Big Thunder Nordic AIAWCA Canada	C8	23767	3105182	92.13	127.31
9	12:02:15	Laura Leclair Senior Women 1997 Chelsea Nordiq (QC) CNEPH Canada	C9	27396	3105222	91.84	131.02
10	12:02:30	Katie Weaver Senior Women 1997 Hollyburn Ski Club Rocky Mountain Racers	C10	26344	3105224	91.09	144.81
11	12:02:45	Felicia Gesior Senior Women 1993 Crosscut Mountain Sports Center United States	C11	30849	3535542	91.08	132.48
12	12:03:00	Matilda Joensson Senior Women 1997 Montana State University Sweden	C12	31752	3506019	91.06	143.55
13	12:03:15	Julia Richter Senior Women 1997 University of Utah Germany	C13	31151	3205506	91.03	135.93
14	12:03:30	Katie Feldman Senior Women 1996 Sun Valley SEF	C14	38790	3535716	91.01	143.66
15	12:03:45	Caitlin Gregg Senior Women 1980 Loppet Nordic Racing Team Gregg/prgFinancial/Madshus United States	C15	13070	3535021	90.99	
16	DNS	Rebecca Rorabaugh Senior Women 1989 APU Nordic Ski Center	C16	20460	3535407	90.85	144.69
17	12:04:15	Anna-Maria Dietze Senior Women 1999 CU Ski Team Germany	C17	34982	3205634	90.74	138.01
18	12:04:30	Karianne Moe Senior Women 1997 University of Utah Norway	C18	32414	3426303	90.46	157.88
19	12:04:45	Leah Lange Senior Women 1998 University of Utah United States	C19	36365	3535678	90.24	161.18
20	12:05:00	Annika Richardson Senior Women 1998 Lappe Nordic AIAWCA	C20	27417	3105236	89.84	155.35
21	12:05:15	Guro Jordheim Senior Women 1996 University of Utah Norway	C21	30724	3426270	89.42	172.26
22	12:05:30	Hannah Mehain Senior Women 1998 Sovereign Lake Nordic BC Ski Team UBC Okanagan	C22	29487	3105268	88.83	173.39
23	12:05:45	Hannah Cole Senior Women 1995 Crosscut Mountain Sports Center	C23	41125	3535780	88.49	182.1
24	12:06:00	Elizabeth Elliott U20 Women 2000 Revelstoke Nordic AIAWCA	C24	31448	3105275	88.08	188.17
25	12:06:15	Benita Peiffer U20 Women 2000 Whistler Nordic AIAWCA Canada	C25	31032	3105256	87.35	222.58

Unofficial Results – Interval-Start Race – Z4 Legacy Program

Haywood NorAM CEC Pursuit Day 1 2019		Date: February 2, 2019
Host Club: Highlands Trailblazers	Unofficial Results	Location: Duntroon
Jury		
Technical Delegate:	Jacques Dumont	
Chief of Competition:	Shawn Sinclair	
Assistant TD	Pierrot Bernier	
Apprentice TD	Claude Laramée	
CCC Race Director	Dave Dyer	

Open Women - 10 km. Classic - 2 Laps x 5K

PL	Bib	Name	SubCategory	CCC	DOB	Club	Team	Time
1	151	Zoë Williams	Senior Women	27366	1997	Nakkertok Nordique (QC)	QCST/ Carleton U	0:35:46.0
2	149	Mia Serratore	Senior Women	23769	1996	Big Thunder Nordic		0:36:23.9
3	142	Laura Leclair	Senior Women	27396	1997	Chelsea Nordiq (QC)	CNEPH	0:37:04.4
4	148	Annika Richardson	Senior Women	27417	1998	Lappe Nordic	NTDC TBay	0:37:04.6
5	153	Alannah Maclean	Senior Women	19646	1993	Big Thunder Nordic	Lakehead U	0:37:41.5
6	146	Katie Weaver	Senior Women	26344	1997	Hollyburn Ski Club	RMR	0:38:28.2
7	143	Tove Halvorsen	Junior Women	31050	1999	Nakkertok Nordique (QC)	QCST	0:38:38.3
8	144	Bronwyn Williams	Junior Women	31834	1999	Nakkertok Nordique (QC)		0:39:05.8
9	152	Liliane Gagnon	Junior Women	36478	2002	Skibec		0:39:42.0
10	141	Alexandra Racine	Junior Women	29499	1999	Orford		0:39:54.4
11	202	Maggie McClure	Senior Women	30248	1998	Halifax Nordic	NSST	0:39:56.4
12	145	Erin Yungblut	Senior Women	21597	1993	Rocky Mountain Racers	RMR	0:40:24.5
13	197	Shaylynn Loewen	Junior Women	33371	2000	Georgian Nordic	NTDC TBay	0:40:26.8
14	150	Hannah Shields	Senior Women	37995	1998	Nakkertok Nordique (QC)		0:40:37.4
15	201	Emma Holmes	Senior Women	29422	1998	Rocky Mountain Racers	Carleton U	0:40:44.1
16	195	Alyssa Stowe	Senior Women	27371	1997	Carleton University	Carleton U	0:40:45.6
17	194	Freya Hik	Senior Women	33376	1995	Hollyburn Ski Club		0:40:46.1
18	200	Erika Mihell	Senior Women	28155	1997	Soo Finnish	Lakehead U	0:40:55.2
19	186	Emily Drake	Senior Women	35751	1998	North Bay Nordic	Nipissing U	0:41:21.3
20	203	Heidi Stewart	Junior Women	27375	2000	Big Thunder Nordic	NTDC TBay	0:41:27.4
21	198	Sonjaa Schmidt	Junior Women	37239	2002	Whitehorse Ski Club	YTST	0:41:37.3
22	187	Sophia Marshall	Junior Women	36521	2003	Highlands Trailblazers		0:41:56.9
23	193	Laura Inkila	Senior Women	25805	1997	Lappe Nordic	Carleton U	0:42:02.1
24	166	Soren Meeuwisse	Senior Women	DL12	1997	Team Hardwood	McMaster U	0:42:06.4
25	199	Chloe Ranahan	Junior Women	33123	2000	Nakkertok Nordic (ON)	Carleton U	0:42:18.8
26	184	Sophia Slater	Junior Women	37777	1999	North Bay Nordic	Nipissing U	0:42:38.9
27	196	Dahlia Lapointe	Junior Women	37234	2002	Whitehorse Ski Club	YTST	0:42:57.8

Results By: **ZONE4**

Haywood NorAM CEC Pursuit Day 1 2019 2019-07-08 Printed at: 7:59:17 PM

Pg: 1

Pursuit Race – 2nd Race Start List – Z4 Legacy Program

Haywood NorAM CEC Pursuit Day 2 2019		Date: February 3, 2019	
Host Club: Highlands Trailblazers	Start List		Location: Duntroon
Jury			
Technical Delegate:	Jacques Dumont	Air Temp:	
Chief of Competition:	Shawn Sinclair	Snow Temp:	
Asst TD	Pierrot Bernier	Weather:	
App TD	Claude Laramée	Wind Dir:	
CCC Race Director	Dave Dyer	Snow Cond:	

Open Women - 15 km. Free Pursuit -

Bib	Start Time	Name	SubCategory	CCCLic	DOB	Club	Team
101	10:00:00.0	Zoë Williams	Senior Women	27366	1997	Nakkertok Nordique (QC)QCST/ Carleton U	
102	10:00:37.0	Mia Serratore	Senior Women	23769	1996	Big Thunder Nordic	
103	10:01:18.0	Laura Leclair	Senior Women	27396	1997	Chelsea Nordiq (QC)	CNEPH
104	10:01:18.0	Annika Richardson	Senior Women	27417	1998	Lappe Nordic	NTDC TBay
105	10:01:55.0	Alannah Maclean	Senior Women	19646	1993	Big Thunder Nordic	Lakehead U
106	10:02:42.0	Katie Weaver	Senior Women	26344	1997	Hollyburn Ski Club	RMR
107	10:02:52.0	Tove Halvorsen	Junior Women	31050	1999	Nakkertok Nordique (QC)QCST	
108	10:03:19.0	Bronwyn Williams	Junior Women	31834	1999	Nakkertok Nordique (QC)	
109	10:03:56.0	Liliane Gagnon	Junior Women	36478	2002	Skibec	
110	10:04:08.0	Alexandra Racine	Junior Women	29499	1999	Orford	
111	10:04:10.0	Maggie McClure	Senior Women	30248	1998	Halifax Nordic	NSST
112	10:04:38.0	Erin Yungblut	Senior Women	21597	1993	Rocky Mountain Racers	RMR
113	10:04:40.0	Shaylynn Loewen	Junior Women	33371	2000	Georgian Nordic	NTDC TBay
114	10:04:51.0	Hannah Shields	Senior Women	37995	1998	Nakkertok Nordique (QC)	
115	10:04:58.0	Emma Holmes	Senior Women	29422	1998	Rocky Mountain Racers	Carleton U
116	10:04:59.0	Alyssa Stowe	Senior Women	27371	1997	Carleton University	Carleton U
117	10:05:00.0	Freya Hik	Senior Women	33376	1995	Hollyburn Ski Club	
118	10:05:09.0	Erika Mihell	Senior Women	28155	1997	Soo Finnish	Lakehead U
119	10:05:35.0	Emily Drake	Senior Women	35751	1998	North Bay Nordic	Nipissing U
120	10:05:41.0	Heidi Stewart	Junior Women	27375	2000	Big Thunder Nordic	NTDC TBay
121	10:05:51.0	Sonjaa Schmidt	Junior Women	37239	2002	Whitehorse Ski Club	YTST
122	10:06:10.0	Sophia Marshall	Junior Women	36521	2003	Highlands Trailblazers	
123	10:06:16.0	Laura Inkila	Senior Women	25805	1997	Lappe Nordic	Carleton U
124	10:06:20.0	Soren Meeuwisse	Senior Women	DL12	1997	Team Hardwood	McMaster U
125	10:06:32.0	Chloe Ranahan	Junior Women	33123	2000	Nakkertok Nordic (ON)	Carleton U
126	10:06:52.0	Sophia Slater	Junior Women	37777	1999	North Bay Nordic	Nipissing U

Pursuit Start List with Lane Assignments

101 10:00:00	<input type="checkbox"/>	102 10:00:37	<input type="checkbox"/>	103 10:01:18	<input type="checkbox"/>
Zoë Williams		Mia Serratore		Laura Leclair	
104 10:01:18	<input type="checkbox"/>	105 10:01:55	<input type="checkbox"/>	106 10:02:42	<input type="checkbox"/>
Annika Richardson		Alannah Maclean		Katie Weaver	
107 10:02:52	<input type="checkbox"/>	108 10:03:19	<input type="checkbox"/>	109 10:03:56	<input type="checkbox"/>
Tove Halvorsen		Bronwyn Williams		Liliane Gagnon	
110 10:04:08	<input type="checkbox"/>	111 10:04:10	<input type="checkbox"/>	112 10:04:38	<input type="checkbox"/>
Alexandra Racine		Maggie McClure		Erin Yungblut	
113 10:04:40	<input type="checkbox"/>	114 10:04:51	<input type="checkbox"/>	115 10:04:58	<input type="checkbox"/>
Shaylynn Loewen		Hannah Shields		Emma Holmes	
116 10:04:59	<input type="checkbox"/>	117 10:05:00	<input type="checkbox"/>	118 10:05:09	<input type="checkbox"/>
Alyssa Stowe		Freya Hik		Erika Mihell	
119 10:05:35	<input type="checkbox"/>	120 10:05:41	<input type="checkbox"/>	121 10:05:51	<input type="checkbox"/>
Emily Drake		Heidi Stewart		Sonjaa Schmidt	
122 10:06:10	<input type="checkbox"/>	123 10:06:16	<input type="checkbox"/>	124 10:06:20	<input type="checkbox"/>
Sophia Marshall		Laura Inkila		Soren Meeuwisse	
125 10:06:32	<input type="checkbox"/>	126 10:06:52	<input type="checkbox"/>	127 10:07:11	<input type="checkbox"/>
Chloe Ranahan		Sophia Slater		Dahlia Lapointe	
128 10:07:56	<input type="checkbox"/>	129 10:08:32	<input type="checkbox"/>	130 10:08:34	<input type="checkbox"/>
Isabelle Maclean		Shelby Dickey		Jessica Roach	
131 10:08:46	<input type="checkbox"/>	132 10:09:15	<input type="checkbox"/>	133 10:09:28	<input type="checkbox"/>
Lotte Kallio		Allison Caswell		Madeline Aarts	
134 10:10:14	<input type="checkbox"/>	135 10:10:24	<input type="checkbox"/>	136 10:10:27	<input type="checkbox"/>
Meghan Burns		Marlee Sauder		Jillian Flower	
137 10:10:32	<input type="checkbox"/>	138 10:10:58	<input type="checkbox"/>	139 10:11:31	<input type="checkbox"/>
Mariah Hudec		Shelby Howard		Raylan Stroud	
140 10:11:36	<input type="checkbox"/>	141 10:12:00	<input type="checkbox"/>	142 10:12:00	<input type="checkbox"/>
Katja Zbogar		Hannah Skelton		Lydia Harris	
143 10:12:00	<input type="checkbox"/>	144 10:12:00	<input type="checkbox"/>	145 10:12:00	<input type="checkbox"/>
Laura Parent		Christine Huet		Emerson Bach	
146 10:12:00	<input type="checkbox"/>	147 10:12:00	<input type="checkbox"/>	148 10:12:00	<input type="checkbox"/>
Katie Grove		Tessa Warkentine		Lindsay Raymond	

Sprint Heat Bracket Result – Z4 Web Based Program

Senior Women – Official

NameRound

Time

Senior Women - Q1		14:19:56
201	Julia Richter	3:18.60
211	Hannah Cole	3:19.18
210	Caitlin Gregg	3:19.24
220	Frédérique Vézina	3:20.10
230	Caroline Brisbois	3:29.98
221	Deedra Irwin	3:47.97

Senior Women - Q2		14:23:59
217	Kaitlynn Miller	3:10.55
204	Anna-Maria Dietze	3:11.00
207	Matilda Joansson	3:11.78
214	Leah Lange	3:16.60
224	Emma Tarbath	3:17.57
227	Tove Halvorsen	3:32.62

Senior Women - Q3		14:27:56
205	Katharine Ogden	3:13.59
206	Maya Macisaac-Jones	3:14.11
216	Annika Richardson	3:15.26
215	Sydney Palmer-Leger	3:15.75
226	Laurence Dumais	3:20.23
225	Katie Weaver	3:33.05

Senior Women - Q4		14:31:57
212	Guro Jordheim	3:11.86
202	Katherine Stewart-Jones	3:12.11
219	Elizabeth Guiney	3:12.68
209	Erika Flowers	3:13.77
222	Felicia Gesior	3:21.85
225	Anna Fake	3:27.49

Senior Women - Q5		14:35:58
205	Alayna Sonnesyn	3:13.43
206	Laura Leclair	3:13.51
213	Katie Feldman	3:13.60
215	Karianne Moe	3:15.02
223	Hannah Mehain	3:17.62
222	Emma Camicioli	3:30.32

Senior Women - S1		14:49:58
205	Katharine Ogden	3:13.57
201	Julia Richter	3:13.86
204	Anna-Maria Dietze	3:14.04
217	Kaitlynn Miller	3:14.61
219	Elizabeth Guiney	3:15.23
211	Hannah Cole	3:17.53

Senior Women - S2		14:53:59
202	Katherine Stewart-Jones	3:15.49
206	Maya Macisaac-Jones	3:15.70
212	Guro Jordheim	3:15.84
203	Alayna Sonnesyn	3:16.64
208	Laura Leclair	3:16.71
207	Matilda Joansson	3:20.19

Senior Women - Final		15:08:00
201	Julia Richter	3:10.52
202	Katherine Stewart-Jones	3:10.60
205	Katharine Ogden	3:11.15
204	Anna-Maria Dietze	3:16.84
217	Kaitlynn Miller	3:17.05
206	Maya Macisaac-Jones	3:25.43

Sprint Race Final Result – Z4 Web Based Program

Senior Women 1.3 k Free – Official

Name	Round	Time
1 Julia Richter 201 1997 31151 3205506 University of Utah DE	Finals	3:07.72
2 Katherine Stewart-Jones 202 1995 23772 3105214 Nakkertok Nordique (QC) CN Ski Team CA	Finals	3:08.04
3 Katharine Ogden 205 1997 31366 3535601 Dartmouth Ski Team US	Finals	3:11.78
4 Anna-Maria Dietze 204 1999 34982 3205634 CU Ski Team DE	Finals	3:11.09
5 Kaitlynn Miller 217 1991 34048 3535636 Craftsbury Nordic Craftsbury Green Racing Project US	Finals	3:19.90
6 Maya MacIsaac-Jones 206 1995 20511 3105180 Rocky Mountain Racers AIAWCA CA	Finals	3:12.50
7 Guro Jordheim 212 1996 30724 3426270 University of Utah NO	Semi-Finals	3:16.48
8 Alayna Sonnesyn 203 1996 34852 3535659 Stratton Mountain School US	Semi-Finals	3:10.08
9 Laura Leclair 208 1997 27396 3105222 Chelsea Nordiq (QC) CNEPH CA	Semi-Finals	3:13.61
10 Elizabeth Guiney 219 1991 20461 3535408 Craftsbury Nordic Craftsbury Green Racing Project US	Semi-Finals	3:20.68
11 Matilda Joansson 207 1997 31752 3506019 Montana State University SE	Semi-Finals	3:12.87
12 Hannah Cole 211 1995 41125 3535780 Crosscut Mountain Sports Center US	Semi-Finals	3:15.73
13 Caitlin Gregg 210 1980 13070 3535021 Loppet Nordic Racing Team Gregg/prgFinancial/Madshus US	Quarter-Finals	3:15.56
14 Katie Feldman 213 1996 38790 3535716 Sun Valley SEF US	Quarter-Finals	3:18.75
15 Annika Richardson 216 1998 27417 3105236 Lappe Nordic AIAWCA CA	Quarter-Finals	3:19.58
16 Erika Flowers 209 1989 18861 3535222 Bridger Ski Foundation Salomon US	Quarter-Finals	3:13.98
17 Leah Lange 214 1998 36365 3535678 University of Utah US	Quarter-Finals	3:19.19
18 Sydney Palmer-Leger 215 2002 41131 3535791 Sun Valley SEF US	Quarter-Finals	3:19.21
19 Karianne Moe 218 1997 32414 3426303 University of Utah NO	Quarter-Finals	3:20.00
20 Frédérique Vézina 220 1994 19234 3105157 Mont-Sainte-Anne CA	Quarter-Finals	3:21.36
21 Felicia Gesior 222 1993 30849 3535542 Crosscut Mountain Sports Center US	Quarter-Finals	3:21.91
22 Hannah Mehain 223 1996 29487 3105268 Sovereign Lake Nordic BC Ski Team CA	Quarter-Finals	3:24.07
23 Emma Tarbath 224 1997 34660 3535649 Montana State University US	Quarter-Finals	3:24.79
24 Laurence Dumais 226 1997 25753 3105213 Fondeurs-Laurentides AIAWCA CA	Quarter-Finals	3:27.48
25 Caroline Brisbois 230 1996 34656 3535637 APU Nordic Ski Center US	Quarter-Finals	3:33.26
26 Deedra Irwin 221 1992 U.S. National Guard U.S. National Guard US	Quarter-Finals	3:21.38
27 Katie Weaver 225 1997 26344 3105224 Hollyburn Ski Club Rocky Mountain Racers CA	Quarter-Finals	3:26.98
28 Tove Halvorsen 227 1999 31050 3105294 Mont-Sainte-Anne CNEPH CA	Quarter-Finals	3:27.80
29 Emma Camicioli 228 1993 25732 Rocky Mountain Racers CA	Quarter-Finals	3:27.93
30 Anna Fake 229 1998 37100 3535665 Montana State University US	Quarter-Finals	3:29.05
31 Gina Cinelli 1997 27408 3105346 Revelstoke Nordic BC Ski Team CA	Qualification	3:36.05
32 Jordi Floyd 1998 36372 3535695 Montana State University US	Qualification	3:36.07
33 Reese Bendiksen 1999 45921 Camrose Nordic Ski Club U of A - Augustana CA	Qualification	3:42.23
34 Freya Hik 1995 33376 Hollyburn Ski Club CA	Qualification	3:43.97
35 Anna Goodwin 1999 29456 Hollyburn Ski Club Rocky Mountain Racers CA	Qualification	3:48.43
36 Clair Littlefair 1998 29497 Yellowknife Ski Club Team Telemark CA	Qualification	3:51.39
37 Anna Zimmerman 1997 27475 Parkland Cross Country CA	Qualification	3:53.08
DNS Sadie White 1996 23767 3105182 Big Thunder Nordic AIAWCA CA	Qualification	
DNS Mariah Bredal 1997 33441 3426503 University of Utah NO	Qualification	
DNS Rebecca Rorabaugh 1989 20460 3535407 APU Nordic Ski Center US	Qualification	

40 Registered 0 Finished 3 Did Not Start 0 Did Not Finish 0 Disqualified

Relay Results – Z4 Legacy Program

OUA Championship Relays 2019		Date: February 18, 2019	
Host Club: Nipissing U		Location: Nipissing University	
Jury		Obs. Time: 10:00	
Technical Delegate:	Al White	Air Temp:	-17
Chief of Competition:	Andrew Rees	Snow Temp:	-14
Coach:	Victor Wiltmann XCSO	Snow Cond:	Machine groom

OUA Women - 3 x 3.75 km. Free Relay -

PL	Bib	Team	Lg	Name	Time	Rnk	Total
1	102	Lakehead A	1	Alannah Maclean	0:12:04.4	(2)	0:37:44.7
			2	Erika Mihell	0:13:20.9	(3)	
			3	Shaylynn Loewen	0:12:19.3	(1)	
2	101	Carleton A	1	Zoe Williams	0:11:47.7	(1)	0:38:29.7
			2	Maggie McClure	0:12:56.4	(1)	
			3	Alyssa Stowe	0:13:45.5	(3)	
3	108	Carleton B	1	Chloe Ranahan	0:12:33.0	(3)	0:39:04.1
			2	Alex Slobodian	0:13:13.2	(2)	
			3	Laura Inkila	0:13:17.9	(2)	
4	104	Nipissing	1	Emily Drake	0:13:03.7	(4)	0:41:25.5
			2	Sophia Slater	0:13:57.4	(4)	
			3	Shelby Dickey	0:14:24.3	(5)	
5	107	Ottawa	1	Katherine Denis	0:13:45.5	(5)	0:44:06.6
			2	Emily Heroux	0:14:37.4	(6)	
			3	Shayna Herr	0:15:43.6	(8)	
6	105	Laurentian	1	Lydia Harris	0:13:59.5	(7)	0:44:31.2
			2	Katie Groves	0:14:58.0	(7)	
			3	Marina Tutz	0:15:33.7	(7)	
7	103	Guelph A	1	Mariah Hudec	0:15:05.0	(11)	0:44:41.2
			2	Madeline Aarts	0:15:12.6	(8)	
			3	Allison Caswell	0:14:23.5	(4)	
8	113	Mix More	1	Jordyn Leighton	0:14:15.2	(8)	0:45:23.7
			2	Shelby Howard	0:14:03.4	(5)	
			3	Jasmin Tuhkasaari	0:17:05.1	(10)	
9	110	Guelph B	1	Katja Zbogar	0:14:56.1	(10)	0:45:25.7
			2	Marian Lutes	0:15:47.4	(9)	
			3	Raylan Stroud	0:14:42.1	(6)	
10	106	Waterloo	1	Hannah Goodings	0:15:56.4	(12)	0:47:55.8
			2	Lauren Denstedt	0:16:04.0	(10)	
			3	Laura Marina Deare	0:15:55.3	(9)	

APPENDIX 10 – ACRONYMS

AS	Athlete Services
CAC	Coaches Association of Canada
CCC	Cross Country Canada
CCES	Canadian Centre for Ethics in Sport
CCR	Canadian Competition Rules
CoC	Chief of Course
CoComp	Chief of Competition
CoS	Chief of Stadium
CPL	Canadian Points List
CS	Competition Secretary
DCO	Doping Control Officer
DCS	Doping Control Station
DNS	Did Not Start
DSQ	Disqualified
EOC	Events Organizing Committee
FIS	Fédération Internationale de Ski / International Ski Federation
FPS	Frames per second
ICR	International Competition Rules
NC	Nordiq Canada (formerly Cross Country Canada)
OC	Organizing Committee
RMS	Race Management System
TCM	Team Captains' Meetings
TD	Technical Delegate
TP	Technical Package
WPNS	World Para Nordic Skiing